

# Canon

# EOS 5D Mark IV

## EOS 5D Mark IV (WG)



Camera

## Wi-Fi (Wireless Communication) Function (Basic)

Instruction manuals (PDF files) can be downloaded from the Canon Web site (p.4).

[www.canon.com/icpd](http://www.canon.com/icpd)



INSTRUCTION  
MANUAL





**Canon**

**EOS 5D Mark IV**  
**EOS 5D Mark IV (WG)**

**Camera Instruction Manual**

# Introduction

The EOS 5D Mark IV is a digital single-lens reflex camera featuring a full-frame (approx. 36.0 x 24.0 mm) CMOS sensor with approx. 30.4 effective megapixels, DIGIC 6+, normal ISO speed range of ISO 100 - ISO 32000, approx. 100% viewfinder coverage, high-precision and high-speed 61-point AF (up to 41 cross-type points), maximum continuous shooting speed of approx. 7.0 shots/sec., 3.2-inch LCD monitor, Dual Pixel RAW shooting, Live View shooting, 4K movie shooting, High Frame Rate (119.9p/100.0p) HD movie shooting, Dual Pixel CMOS AF, Wi-Fi/NFC (wireless communication) function, and GPS function.

## **Before Starting to Shoot, Be Sure to Read the Following**

To avoid botched pictures and accidents, first read the “Safety Precautions” (p.22-24) and “Handling Precautions” (p.25-27). Also, read this manual carefully to ensure that you use the camera correctly.

## **Refer to This Manual while Using the Camera to Further Familiarize Yourself with the Camera**

While reading this manual, take a few test shots and see how they come out. You can then better understand the camera. Be sure to store this manual safely, too, so that you can refer to it again when necessary.

## **Testing the Camera Before Use and Liability**

After shooting, play images back and check whether they have been properly recorded. If the camera or memory card is faulty and the images cannot be recorded or downloaded to a computer, Canon cannot be held liable for any loss or inconvenience caused.

## **Copyrights**

Copyright laws in your country may prohibit the use of your recorded images of people and certain subjects for anything but private enjoyment. Also be aware that certain public performances, exhibitions, etc., may prohibit photography even for private enjoyment.

# Item Check List

Before starting, check that all the following items are included with your camera. If anything is missing, contact your dealer.



**Camera**  
(with body cap)



**Eyecup Eg**



**Battery Pack  
LP-E6N**  
(with protective cover)



**Battery Charger  
LC-E6/LC-E6E\***

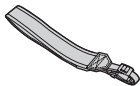

**Wide Strap**

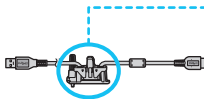

**Interface Cable  
IFC-150U II**



**Cable  
protector**

\* Battery Charger LC-E6 or LC-E6E is provided. (The LC-E6E comes with a power cord.)

- The Instruction Manual and CD-ROMs provided are listed on the next page.
- Attach the Eyecup Eg to the viewfinder eyepiece.
- If you purchased a Lens Kit, check that the lenses are included.
- Depending on the Lens Kit type, Lens Instruction Manuals may also be included.
- Be careful not to lose any of the above items.



When you need Lens Instruction Manuals, download them from the Canon Web site (p.4). The Lens Instruction Manuals (PDF) are for lenses sold individually. Note that when purchasing the Lens Kit, some of the accessories included with the lens may not match those listed in the Lens Instruction Manual.

## Connecting to Peripheral Devices

When connecting the camera to a computer etc., use the provided interface cable or one from Canon. When connecting the interface cable, also use the provided cable protector (p.38).

## Instruction Manuals and CD-ROMs



### **Camera and Wi-Fi (Wireless Communication) Function Basic Instruction Manual**

This booklet consists of the full “Camera Instruction Manual” and the “Wi-Fi (Wireless Communication) Function Basic Instruction Manual”.

The detailed PDF manual for the Wi-Fi/NFC (wireless communication) function can be downloaded from Canon Web site.



### **EOS DIGITAL Solution Disk (Software CD-ROM)**

Contains various software. For more information and installation procedures of the software, see pages 598-599.



### **Software Instruction Manual CD-ROM**

Contains the Software Instruction Manuals (PDF files). Instructions for viewing the Software Instruction Manual CD-ROM are on page 600.

Instruction manuals (PDF files) can be downloaded from the Canon Web site to your computer.

- **Instruction manual (PDF files) download site:**
  - **Camera and Wi-Fi (Wireless Communication) Function Basic Instruction Manual**
  - **Wi-Fi (Wireless Communication) Function Instruction Manual**
  - **Lens Instruction Manual**
  - **Software Instruction Manual**

[www.canon.com/icpd/](http://www.canon.com/icpd/)



- To view the Instruction Manuals (PDF files), Adobe Acrobat Reader DC or other Adobe PDF viewer (most recent version recommended) is required.
- Adobe Acrobat Reader DC can be downloaded for free from the Internet.
- Double-click a downloaded Instruction Manual (PDF file) to open it.
- To learn how to use PDF viewing software, refer to software's Help section.
- You can also access the download site for the Software Instruction Manual from the software installation screen (p.599).

## Compatible Cards

The following cards can be used with the camera regardless of capacity. **If the card is new or was previously formatted (initialized) by another camera or computer, format the card with this camera (p.73).**

- **CF (CompactFlash) cards**  
\* Type I, UDMA Mode 7 supported.
- **SD/SDHC\*/SDXC\* memory cards**  
\* UHS-I cards supported.

### Cards that Can Record Movies

When shooting movies, use a large-capacity card with good enough performances (fast enough reading and writing speeds) to handle the movie recording quality. For details, see page 356.



In this manual, “CF card” refers to CompactFlash cards and “SD card” refers to SD/SDHC/SDXC cards. “Card” refers to all memory cards used to record images or movies.

**\* The camera does not come with a card for recording images/movies.** Please purchase it separately.

# Quick Start Guide

1

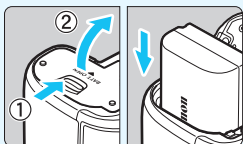

**Insert the battery** (p.44).

- To charge the battery, see page 42.

2

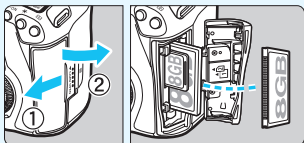

**Insert the card** (p.45).

- The camera-front side slot is for a CF card, and the camera-back side slot is for an SD card.

\* Shooting is possible as long as there is a CF card or an SD card in the camera.

3

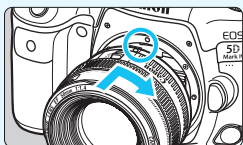

**Attach the lens** (p.55).

- Align the red mount index on the lens with the red mount index on the camera to attach the lens.

4

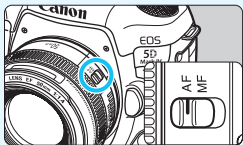

**Set the lens's focus mode switch to <AF>** (p.55).

5

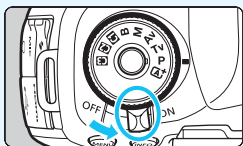

**Set the power switch to <ON>** (p.49).

6

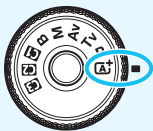

While holding down the center of the Mode Dial, set it to **<AI+> (Scene Intelligent Auto)** (p.35).

- All the necessary camera settings will be set automatically.

7



**Focus on the subject** (p.58).

- Look through the viewfinder and aim the viewfinder center over the subject.
- Press the shutter button halfway, and the camera will focus on the subject.

8

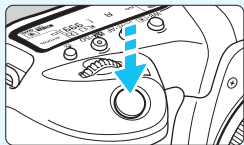

**Take the picture** (p.58).

- Press the shutter button completely to take the picture.

9









**Review the picture.**

- The image just captured will be displayed for approx. 2 sec. on the LCD monitor.
- To display the image again, press the **<▶>** button (p.394).



- To shoot while looking at the LCD monitor, see “Live View Shooting” (p.297).
- To view the images captured so far, see “Image Playback” (p.394).
- To delete images, see “Erasing Images” (p.439).

# Conventions Used in this Manual

## Icons in this Manual

-  : Indicates the Main Dial.
-  : Indicates the Quick Control Dial.
-  : Indicates the AF area selection button.
-  : Indicates the Multi-controller.
-  : Indicates the Setting button.
-  : Indicates that each function remains active for approx. 4 sec., 6 sec., 8 sec., 10 sec., or 16 sec. after you let go of the button.

\* In addition to the above, the icons and symbols used on the camera's buttons and displayed on the LCD monitor are also used in this manual when discussing relevant operations and functionality.

- MENU** : Indicates a function that can be changed by pressing the <MENU> button to change its settings.
- ☆ : This icon at the upper right of the page titles indicates that the function is available only in the <P>, <Tv>, <Av>, <M>, or <B> mode.
- (p.\*\*): Reference page numbers for more information.
-  : Warning to prevent shooting problems.
-  : Supplemental information.
-  : Tips or advice for better shooting.
- ?: Troubleshooting advice.

## Basic Assumptions

- All operations explained in this manual assume that the power switch is set to <ON> and the <LOCK▶> switch is set to the left (Multi function lock released) (p.49, 62).
- It is assumed that all the menu settings and Custom Functions are set to their defaults.
- The illustrations in this manual show the camera attached with the EF50mm f/1.4 USM lens as an example.



# Chapters



	<b>Introduction</b>	2
<b>1</b>	<b>Getting Started and Basic Camera Operations</b>	41
<b>2</b>	<b>Basic Shooting</b>	93
<b>3</b>	<b>Setting the AF and Drive Modes</b>	99
<b>4</b>	<b>Image Settings</b>	165
<b>5</b>	<b>GPS Settings</b>	227
<b>6</b>	<b>Advanced Operations for Photographic Effects</b>	243
<b>7</b>	<b>Flash Photography</b>	285
<b>8</b>	<b>Shooting with the LCD Monitor (Live View Shooting)</b>	297
<b>9</b>	<b>Shooting Movies</b>	333
<b>10</b>	<b>Image Playback</b>	393
<b>11</b>	<b>Post-Processing Images</b>	445
<b>12</b>	<b>Sensor Cleaning</b>	457
<b>13</b>	<b>Transferring Images to a Computer and Print Ordering</b>	465
<b>14</b>	<b>Customizing the Camera</b>	479
<b>15</b>	<b>Reference</b>	523
<b>16</b>	<b>Downloading Images to a Computer / Software</b>	595

# Contents

## **Introduction** **2**

Item Check List.....	3
Instruction Manuals and CD-ROMs.....	4
Compatible Cards.....	5
Quick Start Guide .....	6
Conventions Used in this Manual.....	8
Chapters.....	9
Index to Features .....	18
Safety Precautions .....	22
Handling Precautions .....	25
Nomenclature .....	28

## **1 Getting Started and Basic Camera Operations** **41**

Charging the Battery .....	42
Installing and Removing the Battery.....	44
Installing and Removing the Card .....	45
Turning on the Power .....	49
Setting the Date, Time, and Zone.....	51
Selecting the Interface Language.....	54
Attaching and Detaching a Lens.....	55
Basic Shooting Operations.....	57
 Quick Control for Shooting Functions .....	64
 Menu Operations.....	67
 Operating the Camera with Touch Screen .....	70

Before You Start .....	73
Formatting the Card .....	73
Disabling the Beeper .....	76
Setting the Power-off Time/Auto Power Off.....	76
Setting the Image Review Time .....	77
Reverting the Camera to the Default Settings.....	77
⌘ Displaying the Grid in the Viewfinder .....	81
📷 Displaying the Electronic Level .....	82
Setting the Viewfinder Information Display .....	84
<b>INFO.</b> Button Functions .....	86
LOCK▶ Setting Multi Function Lock.....	90
🔍 Help .....	91

## 2 Basic Shooting 93

📷 Fully Automatic Shooting (Scene Intelligent Auto) .....	94
📷 Full Auto Techniques (Scene Intelligent Auto).....	97

## 3 Setting the AF and Drive Modes 99

AF: Selecting the AF Operation .....	100
📷 Selecting the AF Area and AF Point .....	104
AF Area Selection Modes .....	109
AF Sensor .....	113
Lenses and Usable AF Points.....	115
Selecting AI Servo AF Characteristics .....	127
Customizing AF Functions .....	136
Fine Adjustment of AF's Point of Focus .....	152

When Autofocus Fails .....	158
MF: Manual Focus .....	159
📷 Selecting the Drive Mode .....	160
🕒 Using the Self-timer .....	163







## **4 Image Settings 165**

Selecting the Card for Recording and Playback.....	166
Setting the Image-Recording Quality .....	169
Setting the Dual Pixel RAW Function .....	175
<b>ISO</b> : Setting the ISO Speed for Still Photos .....	177
🎨 Selecting a Picture Style .....	183
🎨 Customizing a Picture Style .....	187
🎨 Registering a Picture Style .....	190
<b>WB</b> : Setting the White Balance .....	192
🔧 White Balance Correction .....	198
Auto Correction of Brightness and Contrast .....	201
Setting Noise Reduction .....	202
Highlight Tone Priority .....	206
Correction of Lens Aberrations due to Optical Characteristics.....	207
Reducing Flicker.....	215
Setting the Color Space.....	217
Creating and Selecting a Folder .....	218
Changing the File Name.....	220
File Numbering Methods .....	223
Setting Copyright Information.....	225

## 5 GPS Settings 227

















GPS Features .....	228
GPS Precautions .....	230
Acquiring GPS Signals.....	231
Setting the Positioning Interval .....	236
Setting Time from GPS on the Camera .....	237
Logging the Route Traveled.....	238









## 6 Advanced Operations for Photographic Effects 243

<b>P</b> : Program AE.....	244
<b>Tv</b> : Shutter-Priority AE .....	246
<b>Av</b> : Aperture-Priority AE.....	248
<b>M</b> : Manual Exposure.....	251
 Selecting the Metering Mode .....	253
 Setting the Desired Exposure Compensation .....	255
 Auto Exposure Bracketing (AEB) .....	257
 Lock the Exposure for Shooting (AE Lock) .....	259
<b>B</b> : Long (Bulb) Exposures.....	260
<b>HDR</b> : HDR (High Dynamic Range) Shooting.....	263
 Multiple Exposures.....	268
 Mirror Lockup .....	276
Using the Eyepiece Cover .....	278
Using a Remote Switch.....	279
 Remote Control Shooting.....	279
<b>TIMER</b> Interval Timer Shooting .....	281

<b>7</b>	<b>Flash Photography</b>	<b>285</b>
	⚡ Flash Photography .....	286
	Setting the Flash Function.....	289
<b>8</b>	<b>Shooting with the LCD Monitor (Live View Shooting)</b>	<b>297</b>
	📷 Shooting with the LCD Monitor .....	298
	Shooting Function Settings .....	307
	Menu Function Settings.....	309
	Selecting the AF Operation .....	314
	Focusing with AF (AF Method).....	316
	👉 Shooting with the Touch Shutter.....	327
	MF: Focusing Manually .....	329
<b>9</b>	<b>Shooting Movies</b>	<b>333</b>
	🎬 Shooting Movies.....	334
	Autoexposure Shooting .....	334
	Shutter-priority AE .....	335
	Aperture-priority AE .....	336
	Manual Exposure Shooting.....	340
	Shooting Function Settings .....	349
	Setting the Movie Recording Quality .....	351
	Setting the Sound Recording .....	362
	Setting the Time Code.....	365
	Shooting HDR Movies .....	369
	⌚🎬 Shooting Time-lapse Movies .....	371
	Menu Function Settings.....	379

**10 Image Playback 393**

 Image Playback .....	394
<b>INFO.:</b> Shooting Information Display .....	397
 Searching for Images Quickly .....	403
 Display Multiple Images on One Screen (Index Display) .....	403
 Jumping through Images (Jump Display) .....	404
 Magnifying Images .....	406
 Comparing Images (Two-Image Display) .....	408
 Playing Back with the Touch Screen .....	409
 Rotating the Image .....	411
 Protecting Images .....	412
Setting Ratings .....	415
 Quick Control for Playback .....	418
 Enjoying Movies .....	420
 Playing Back Movies .....	422
 Editing a Movie's First and Last Scenes .....	425
 Grabbing Frames from 4K Movies .....	427
Slide Show (Auto Playback) .....	429
Viewing Images on a TV Set .....	432
 Copying Images .....	435
 Erasing Images .....	439
Changing Image Playback Settings .....	442
Adjusting the LCD Monitor Brightness .....	442
Setting the LCD Monitor Color Tone .....	443
Auto Rotation of Vertical Images .....	444

<b>11</b>	<b>Post-Processing Images</b>	<b>445</b>
	 Processing RAW Images with the Camera.....	446
	 Resizing JPEG Images.....	452
	 Cropping JPEG Images .....	454
<b>12</b>	<b>Sensor Cleaning</b>	<b>457</b>
	 Automatic Sensor Cleaning .....	458
	Appending Dust Delete Data .....	460
	Manual Sensor Cleaning .....	463
<b>13</b>	<b>Transferring Images to a Computer and Print Ordering</b>	<b>465</b>
	 Transferring Images to a Computer .....	466
	 Digital Print Order Format (DPOF) .....	471
	 Specifying Images for a Photobook.....	476
<b>14</b>	<b>Customizing the Camera</b>	<b>479</b>
	Custom Functions .....	480
	Custom Function Settings .....	482
	C.Fn1: Exposure.....	482
	C.Fn2: Exposure.....	488
	C.Fn3: Display / Operation .....	489
	C.Fn4: Others .....	491
	 Custom Controls .....	495
	Custom Quick Control .....	510
	Registering My Menu .....	515
	 Registering Custom Shooting Modes .....	520



**15 Reference 523**

System Map .....	524
Checking the Battery Information.....	526
Using a Household Power Outlet.....	530
 Using Eye-Fi Cards .....	532
Function Availability Table by Shooting Mode.....	536
Menu Settings .....	540
Troubleshooting Guide.....	554
Error Codes.....	573
Specifications .....	574

**16 Downloading Images to a Computer / Software 595**

Downloading Images to a Computer.....	596
Software Overview .....	598
Installing the Software.....	599
Software Instruction Manual .....	600
Index .....	601

# Index to Features

## Power

- Charging the battery → p.42
- Battery level → p.50
- Battery information check → p.526
- Household power outlet → p.530
- Auto power off → p.76

## Cards

- Formatting → p.73
- Recording function → p.166
- Selecting card → p.168
- Releasing shutter without card → p.46

## Lens

- Attaching → p.55
- Detaching → p.56

## Basic Settings

- Language → p.54
- Date/Time/Zone → p.51
- Beeper → p.76
- Copyright information → p.225
- Clear all camera settings → p.77

## Viewfinder

- Dioptic adjustment → p.57
- Eyepiece cover → p.278
- Electronic level → p.83
- Grid display → p.81
- Information display in viewfinder → p.84

## LCD monitor

- Touch control → p.70
- Brightness → p.442
- Color tone → p.443
- Electronic level → p.82
- Help → p.91

## AF

- AF operation → p.100
- AF area selection mode → p.104
- AF point selection → p.107
- AF point registration → p.500
- Lens group → p.115
- AI Servo AF characteristics → p.127
- EOS iTR AF → p.147
- Customizing AF functions → p.136
- Viewfinder display illumination → p.150
- AF Microadjustment → p.152
- Manual focusing → p.159

## Metering

- Metering mode → p.253

## Drive

- Drive mode → p.160
- Self-timer → p.163
- Maximum burst → p.174

## Recording Images

- Recording function → p.166
- Selecting card → p.168
- Creating/Selecting a folder → p.218
- File name → p.220
- File numbering → p.223

## Image Quality

- Image-recording quality → p.169
- Dual Pixel RAW shooting → p.175
- ISO speed (still photos) → p.177
- Picture Style → p.183
- White balance → p.192
- Auto Lighting Optimizer → p.201
- Noise reduction for high ISO speeds → p.202
- Noise reduction for long exposures → p.204
- Highlight tone priority → p.206
- Lens aberration correction → p.207
- Reducing flicker → p.215
- Color space → p.217

## Shooting

- Shooting mode → p.35
- HDR mode → p.263
- Multiple exposures → p.268
- Mirror lockup → p.276
- Bulb timer → p.261
- Interval timer → p.281
- Depth-of-field preview → p.250
- Remote switch → p.279
- Remote control → p.279
- Quick Control → p.64
- Multi function lock → p.90

## Exposure

- Exposure compensation → p.255
- Exposure compensation with M+ISO Auto → p.252
- AEB → p.257
- AE lock → p.259
- Safety shift → p.485

## GPS

- GPS → p.227
- Logging → p.238

**Flash**

- External flash → p.286
- Flash exposure compensation → p.286
- FE lock → p.286
- Flash function settings → p.289
- Flash Custom Function settings → p.294

**Live View Shooting**

- Live View shooting → p.297
- AF operation → p.314
- AF method → p.316
- Touch shutter → p.327
- Aspect ratio → p.310
- Magnified view → p.325
- Manual focusing → p.329
- Exposure simulation → p.311
- Silent LV shooting → p.312

**Movie Shooting**

- Movie shooting → p.333
- ISO speed (movie) → p.379
- AF method → p.316
- Movie Servo AF → p.380
- Movie Servo AF speed → p.383
- Movie Servo AF tracking sensitivity → p.384
- Movie recording quality → p.351
- 24.00p → p.357
- High Frame Rate movie → p.358
- HDR movie shooting → p.369
- Time-lapse movie → p.371
- Sound recording → p.362
- Microphone → p.363
- Headphones → p.363
- Wind filter → p.363
- Attenuator → p.363
- Time code → p.365
- HDMI output → p.387
- Remote control shooting → p.389

## Playback

- Image review time → p.77
- Single-image display → p.394
- Shooting information display → p.397
- Index display → p.403
- Image browsing (Jump display) → p.404
- Magnified view → p.406
- Two-image display → p.408
- Image rotate → p.411
- Protect → p.412
- Rating → p.415
- Movie playback → p.422
- Editing a movie's first and last scenes → p.425
- Frame Grab (4K) → p.427
- Slide show → p.429
- Viewing images on a TV set → p.432
- Copying → p.435
- Erasing → p.439
- Quick Control → p.418

## Image Editing

- RAW image processing → p.446
- Resizing JPEGs → p.452
- Cropping JPEGs → p.454

## Image Transfer / Print Ordering

- Image transfer (to a computer) → p.466
- Print Order (DPOF) → p.471
- Photobook Set-up → p.476

## Customization

- Custom Functions (C.Fn) → p.480
- Custom Controls → p.495
- Custom Quick Control → p.510
- My Menu → p.515
- Custom shooting mode → p.520

## Sensor Cleaning and Dust Reduction

- Sensor cleaning → p.458
- Append Dust Delete Data → p.460
- Manual sensor cleaning → p.463

## Interface

- Cable protector → p.38

## Errors

- Error codes → p.573

## Software

- Overview → p.598
- Installation → p.599
- Instruction Manual → p.600

## Wi-Fi/NFC Functions

- Wi-Fi (Wireless Communication) Function Manual

# Safety Precautions

The following precautions are provided to prevent harm or injury to yourself and others. Make sure to thoroughly understand and follow these precautions before using the product.

**If you experience any malfunctions, problems, or damage to the product, contact the nearest Canon Service Center or the dealer from whom you purchased the product.**



**Warnings:** Follow the warnings below. Otherwise, death or serious injuries may result.

- To prevent fire, excessive heat, chemical leakage, explosions, and electrical shock, follow the safeguards below:
  - Do not use any batteries, power sources, or accessories not specified in the Instruction Manual. Do not use any home-made or modified batteries, or the product if it is damaged.
  - Do not short-circuit, disassemble, or modify the battery. Do not apply heat or solder to the battery. Do not expose the battery to fire or water. Do not subject the battery to strong physical shock.
  - Do not insert the battery's plus and minus ends incorrectly.
  - Do not recharge the battery in temperatures outside the allowable charging (working) temperature range. Also, do not exceed the recharge time indicated in the Instruction Manual.
  - Do not insert any foreign metallic objects into the electrical contacts of the camera, accessories, connecting cables, etc.
- When disposing of a battery, insulate the electrical contacts with tape. Contact with other metallic objects or batteries may cause a fire or an explosion.
- If excessive heat, smoke, or fumes are emitted when recharging the battery, immediately unplug the battery charger from the power outlet to stop recharging. Otherwise, it may cause a fire, heat damage, or electrical shock.
- If the battery leaks, changes color, deforms, or emits smoke or fumes, remove it immediately. Be careful not to get burned in the process. It may cause a fire, electrical shock or burns if you keep using it.
- Prevent any battery leakage from contacting your eyes, skin, and clothing. It can cause blindness or skin problems. If the battery leakage comes in contact with your eyes, skin, or clothing, flush the affected area with lots of clean water without rubbing it. See a physician immediately.
- Do not leave any cords near a heat source. It can deform the cord or melt the insulation and cause a fire or electrical shock.
- Do not hold the camera in the same position for long periods of time. Even if the camera does not feel too hot, prolonged contact with the same body part may cause skin redness or blistering due to low-temperature contact burns. Using a tripod is recommended for people with circulation problems or very sensitive skin, or when using the camera in very hot places.
- Do not fire the flash at anyone driving a car or other vehicle. It may cause an accident.

- When the camera or accessories are not in use, make sure to remove the battery and disconnect the power plug from the equipment before storing. This is to prevent electrical shock, excessive heat, fire, and corrosion.
- Do not use the equipment where there is flammable gas. This is to prevent an explosion or a fire.
- If you drop the equipment and the casing breaks open to expose the internal parts, do not touch the exposed internal parts. There is a possibility of an electrical shock.
- Do not disassemble or modify the equipment. High-voltage internal parts can cause electrical shock.
- Do not look at the sun or an extremely bright light source through the camera or lens. Doing so may damage your vision.
- Keep equipment out of the reach of children and infants, including when in use. Straps or cords may accidentally cause choking, electrical shock, or injury. Choking or injury may also occur if a child or infant accidentally swallows a camera part or accessory. If a child or infant swallows a part or accessory, consult a physician immediately.
- Do not use or store the equipment in dusty or humid places. Likewise, keep the battery away from metallic items and store it with its protective cover attached to prevent short-circuit. This is to prevent fire, excessive heat, electrical shock, and burns.
- Before using the camera inside an airplane or hospital, check if it is allowed. Electromagnetic waves emitted by the camera may interfere with the plane's instruments or the hospital's medical equipment.
- To prevent a fire and electrical shock, follow the safeguards below:
  - Always insert the power plug all the way in.
  - Do not handle a power plug with wet hands.
  - When unplugging a power plug, grasp and pull the plug instead of the cord.
  - Do not scratch, cut, or excessively bend the cord or put a heavy object on the cord. Also do not twist or tie the cords.
  - Do not connect too many power plugs to the same power outlet.
  - Do not use a cord whose wire is broken or insulation is damaged.
- Unplug the power plug periodically and clean off the dust around the power outlet with a dry cloth. If the surrounding is dusty, humid, or oily, the dust on the power outlet may become moist and short-circuit the outlet, causing a fire.
- Do not connect the battery directly to an electrical outlet or a car's cigarette lighter outlet. The battery may leak, generate excessive heat or explode, causing fire, burns, or injuries.
- A thorough explanation of how to use the product by an adult is required when the product is used by children. Supervise children while they are using the product. Incorrect usage may result in electrical shock or injury.
- Do not leave a lens or lens-attached camera in the sun without the lens cap attached. Otherwise, the lens may concentrate the sun's rays and cause a fire.
- Do not cover or wrap the product with a cloth. Doing so may trap heat within and cause the casing to deform or catch fire.
- Be careful not to get the camera wet. If you drop the product in the water or if water or metal get inside the product, promptly remove the battery. This is to prevent fire, electrical shock, and burns.
- Do not use paint thinner, benzene, or other organic solvents to clean the product. Doing so may cause fire or a health hazard.



**Cautions:** Follow the cautions below. Otherwise, physical injury or property damage may result.

- Do not use or store the product in a high-temperature location such as inside a car under the hot sun. The product may become hot and cause burns. Doing so may also cause battery leakage or explosion, which will degrade the performance or shorten the life of the product.
- Do not carry the camera around when it is attached to a tripod. Doing so may cause an injury or an accident. Also make sure the tripod is sturdy enough to support the camera and lens.
- Do not leave the product in a low-temperature environment for an extended period of time. The product will become cold and may cause injury when touched.
- Do not fire the flash near the eyes. It may hurt the eyes.
- Never play the provided CD-ROM in a drive that is not compatible with the CD-ROM. If you use it in a music CD player, you may damage the speakers and other components. When using headphones, there is also a risk of injury to your ears from excessively loud volume.
- While listening with headphones, do not change the sound-recording settings. Doing so may cause a blast of loud sound that will hurt your ears.



# Handling Precautions

## Camera Care

- This camera is a precision instrument. Do not drop it or subject it to physical shock.
- The camera is not waterproof and cannot be used underwater.
- To maximize the camera's dust- and drip- resistance, keep the terminal cover, battery compartment cover, card slot cover, and all other covers firmly closed.
- This camera is designed to be dust- and drip- resistant, in order to help prevent sand, dust, dirt, or water that falls on it unexpectedly from getting inside, but it is impossible to prevent dirt, dust, water, or salt from getting inside at all. As far as possible, do not allow dirt, dust, water, and salt to get on the camera.
- If water gets on the camera, wipe it off with a dry and clean cloth. If dirt, dust, or salt gets on the camera, wipe it off with a clean, well-wrung wet cloth.
- Using the camera in a location with large amounts of dirt or dust may cause a malfunction.
- Cleaning the camera after use is recommended. Allowing dirt, dust, water, or salt to remain on the camera may cause a malfunction.
- If you accidentally drop the camera into water or are concerned that moisture (water), dirt, dust, or salt may have gotten inside it, promptly consult the nearest Canon Service Center.
- Never leave the camera near anything having a strong magnetic field such as a magnet or electric motor. Also, avoid using or leaving the camera near anything emitting strong radio waves, such as a large antenna. Strong magnetic fields can cause camera misoperation or destroy image data.
- Do not leave the camera in excessive heat, such as in a car in direct sunlight. High temperatures can cause the camera to malfunction.
- The camera contains precision electronic circuitry. Never attempt to disassemble the camera yourself.

- Do not block the mirror operation with your finger, etc. Doing so may cause a malfunction.
- Use only a commercially-available blower to blow away dust when it adheres to the lens, viewfinder, reflex mirror, focusing screen, etc. Do not use cleaners that contain organic solvents to clean the camera body or lens. For stubborn dirt, take the camera to the nearest Canon Service Center.
- Do not touch the camera's electrical contacts with your fingers. This is to prevent the contacts from corroding. Corroded contacts can cause camera malfunction.
- If the camera is suddenly brought in from the cold into a warm room, condensation may form on the camera and internal parts. To prevent condensation, first put the camera in a sealed plastic bag and let it adjust to the warmer temperature before taking it out of the bag.
- If condensation forms on the camera, do not use the camera. This is to avoid damaging the camera. If there is condensation, remove the lens, card and battery from the camera, and wait until condensation has evaporated before using the camera.
- If the camera will not be used for an extended period, remove the battery and store the camera in a cool, dry, well-ventilated location. Even while the camera is in storage, press the shutter button a few times once in a while to check that the camera is still working.
- Avoid storing the camera where there are chemicals that result in rust and corrosion such as in a chemical lab.
- If the camera has not been used for an extended period, test all its functions before using it. If you have not used the camera for some time or if there is an important shoot such as a foreign trip coming up, have the camera checked by your nearest Canon Service Center or check the camera yourself and make sure it is working properly.
- If you repeat continuous shooting or perform Live View shooting or movie shooting for a prolonged period, the camera may become hot. This is not a malfunction.
- If there is a bright light source inside or outside the image area, ghosting may occur.

## LCD Panel and LCD Monitor

- Although the LCD monitor is manufactured with very high precision technology with over 99.99% effective pixels, 0.01% or fewer of the pixels may be dead, and there may also be spots of black, red, or other colors. Dead pixels are not a malfunction. They do not affect the images recorded.
- If the LCD monitor is left on for a prolonged period, screen burn-in may occur where you see remnants of what was displayed. However, this is only temporary and will disappear when the camera is left unused for a few days.
- The LCD monitor display may seem slightly slow in low temperatures, or look black in high temperatures. It will return to normal at room temperature.

## Cards

To protect the card and its recorded data, note the following:

- Do not drop, bend, or wet the card. Do not subject it to excessive force, physical shock, or vibration.
- Do not touch the card's electronic contacts with your fingers or anything metallic.
- Do not affix any stickers, etc., on the card.
- Do not store or use the card near anything that has a strong magnetic field, such as a TV set, speakers, or magnets. Also avoid places prone to having static electricity.
- Do not leave the card in direct sunlight or near a heat source.
- Store the card in a case.
- Do not store the card in hot, dusty, or humid locations.

## Lens

After detaching the lens from the camera, put down the lens with the rear end up and attach the rear lens cap to avoid scratching the lens surface and electrical contacts.

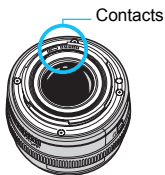

# Nomenclature

<DRIVE•AF>

Drive mode selection/  
AF operation selection button  
(p.160, 163/100)

<ISO> Flash exposure  
compensation/ISO speed  
setting button (p.286/177)

<LCD> LCD panel  
illumination button  
(p.63)

<Main Dial>  
(p.59)

Shutter button  
(p.58)

Self-timer lamp  
(p.163)

Remote control  
sensor (p.279)

Grip  
(Battery  
compartment)

DC coupler cord hole  
(p.530)

Depth-of-field preview button  
(p.250)



Body cap (p.55)

<WB•METERING> White balance selection/  
Metering mode selection button (p.192/253)

<M-Fn> Multi function button  
(p.62, 106, 286, 495)

GPS antenna

Lens mount index (p.55)

Flash sync contacts

Hot shoe (p.286)

Mode Dial lock-release  
button (p.59)

Mode Dial (p.35, 59)

Built-in  
microphone  
(p.363)

Strap mount  
(p.37)

Lens release  
button (p.56)

Terminal cover

Lens lock pin

Lens mount

Contacts (p.27)

Mirror (p.276, 463)

Remote control terminal  
(N3 type) (p.279)

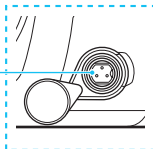

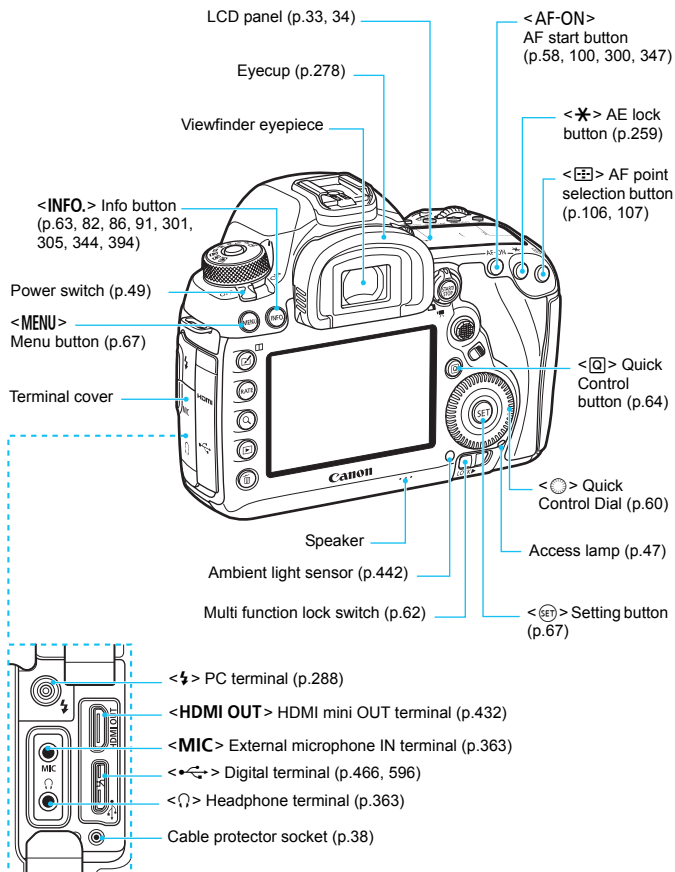

When connecting the interface cable to a digital terminal, use the provided cable protector (p.38).

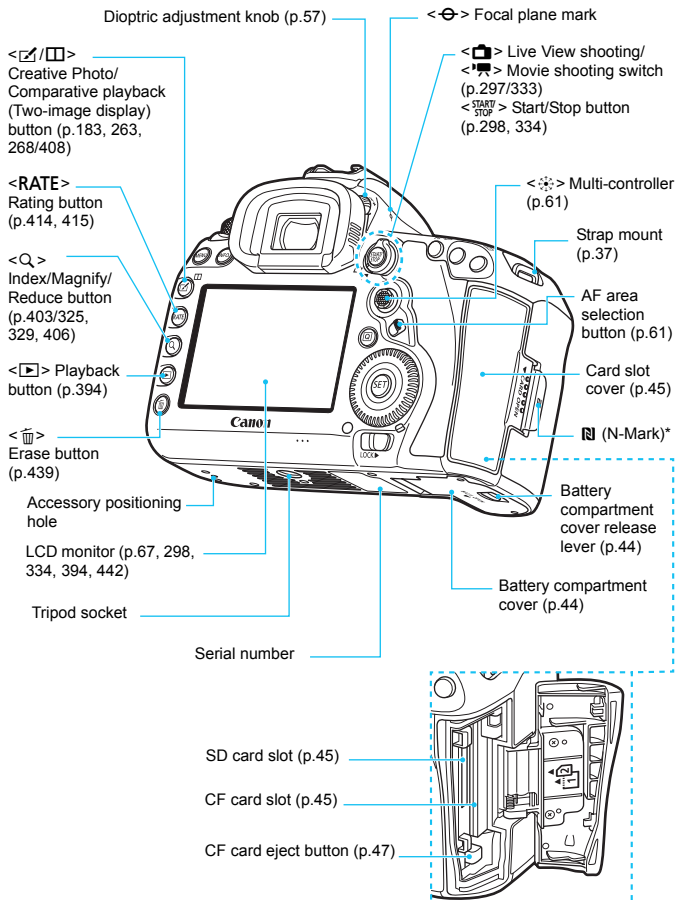

\* Used for wireless connections with the NFC function.

## Viewfinder Information

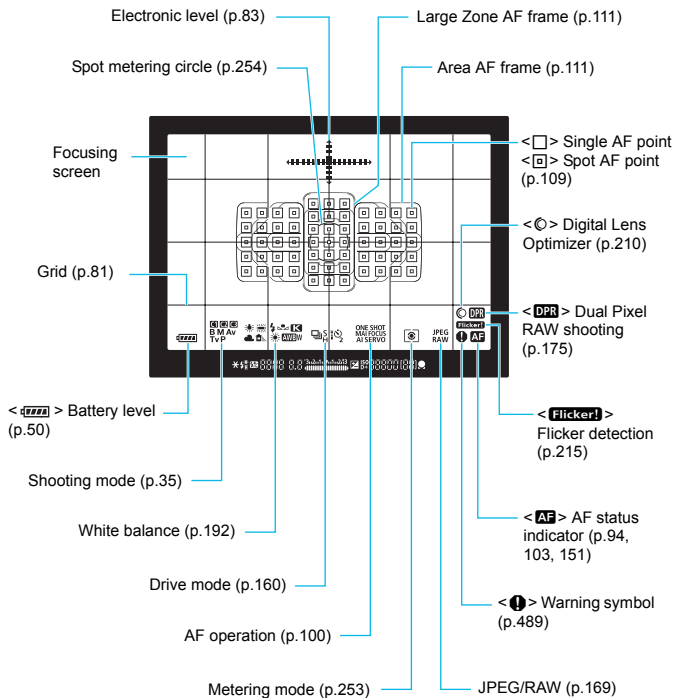

\* The display will show only the settings currently applied.

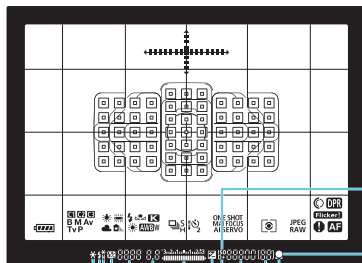

- < \* > AE lock (p.259)  
AEB in-progress (p.257)
- < ⚡ > Flash-ready (p.286)  
Improper FE lock warning
- < ⚡ \* > FE lock (p.286)  
FEB in-progress (p.293)
- < ⚡ H > High-speed sync (p.293)
- < [ ] > Flash exposure compensation (p.286)
- Shutter speed (p.246)
- Bulb (**buLb**) (p.260)
- FE lock (**FEL**)
- Busy (**buSY**)
- Multi function lock warning (**L**)
- No card warning (**Card**)
- Error code (**Err**)
- Aperture (p.248)
- Dust Delete Data acquisition (- -)
- < ISO > ISO speed indicator (p.177)
- < ● > Focus indicator (p.94, 101)
- < ↖ ↗ > AF status indicator (p.103, 151)
- Maximum burst (p.174)
- Number of remaining multiple exposures (p.270)
- ISO speed (p.177)
- < D+ > Highlight tone priority (p.206)
- < [ ] > Exposure compensation (p.255)
- Exposure level indicator
- Exposure compensation amount (p.255)
- AEB range (p.257)
- Flash exposure compensation (p.286)
- AF point selection (**[ ] AF, SEL [ ], SEL AF**)
- AF point registration (**[ ] HP, SEL [ ], SEL HP**)
- Card warning (**Card 1/2/1,2**)
- Card full warning (**FuLL 1/2/1,2**)



## LCD Panel

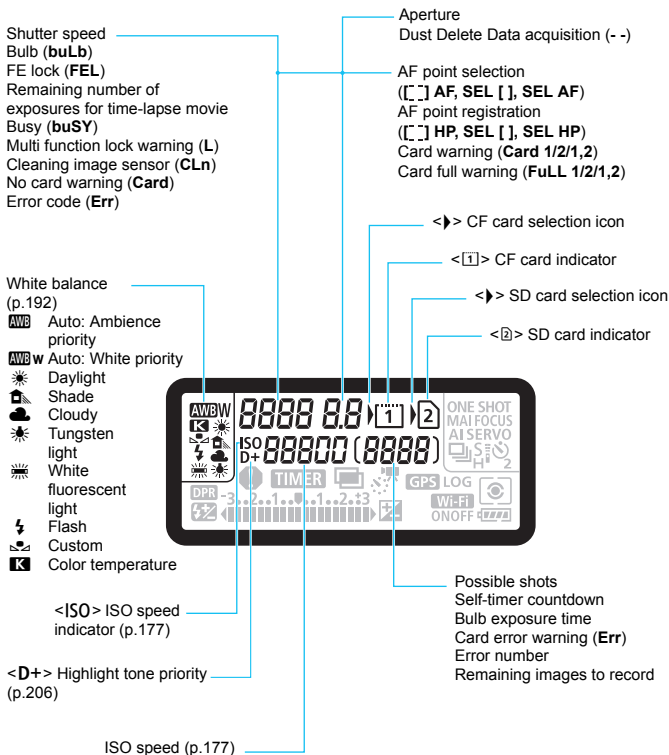

\* The display will show only the settings currently applied.

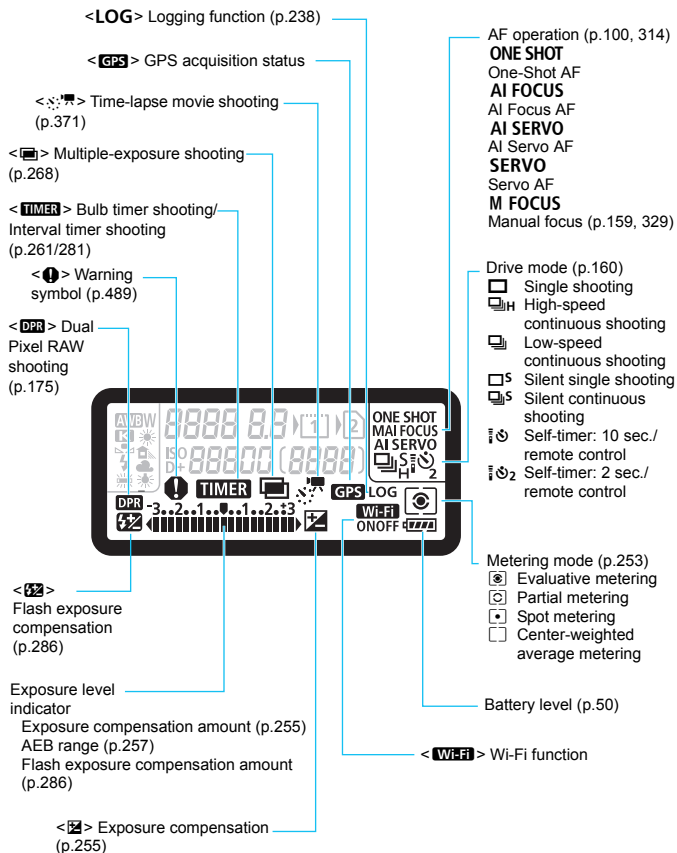

## Mode Dial

You can set the shooting mode. Turn the Mode Dial while holding down the Mode Dial center (Mode Dial lock release button).

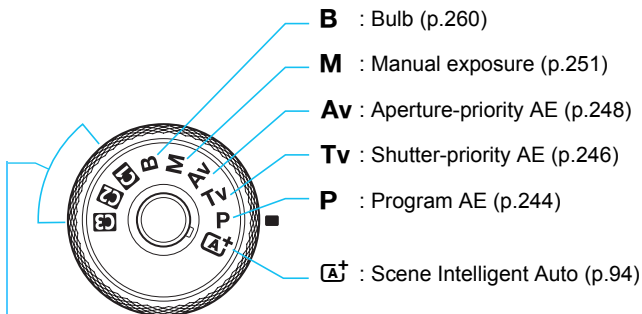

## Custom shooting mode

You can register the shooting mode (<**P**>, <**Tv**>, <**Av**>, <**M**>, or <**B**>), AF operation, menu settings, etc., to the <**C1**>, <**C2**>, and <**C3**> Mode Dial positions (p.520).

## Battery Charger LC-E6

Charger for Battery Pack LP-E6N/LP-E6 (p.42).

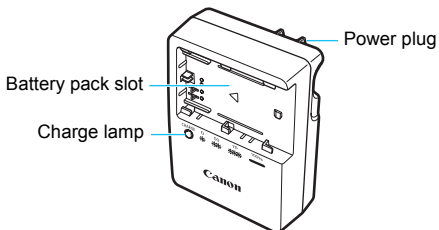

**IMPORTANT SAFETY INSTRUCTIONS-SAVE THESE INSTRUCTIONS.  
DANGER-TO REDUCE THE RISK OF FIRE OR ELECTRIC SHOCK,  
CAREFULLY FOLLOW THESE INSTRUCTIONS.**

For connection to a supply not in the U.S.A., use an attachment plug adapter of the proper configuration for the power outlet, if needed.

## Battery Charger LC-E6E

Charger for Battery Pack LP-E6N/LP-E6 (p.42).

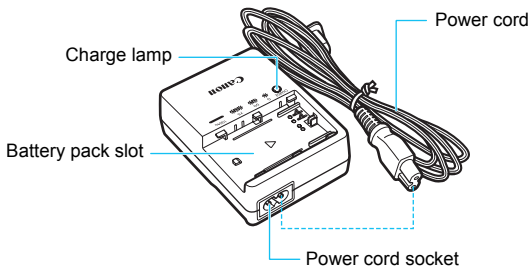

## Attaching the Strap

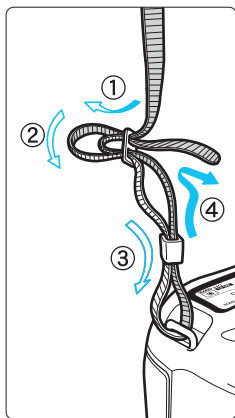

Pass the end of the strap through the camera's strap mount eyelet from the bottom. Then pass it through the strap's buckle as shown in the illustration. Pull the strap to take up any slack and make sure the strap will not loosen from the buckle.

- The eyepiece cover is also attached to the strap (p.278).

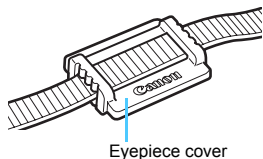

## Using the Cable Protector

When connecting the camera to a computer or the Connect Station, use the provided interface cable or one from Canon (shown in the System Map on page 525).

When connecting the interface cable, also **use the provided cable protector**. Using the cable protector prevents the cable from accidental disconnection and the terminal from getting damaged.

### Using the Provided Interface Cable and a Genuine HDMI Cable (sold separately)

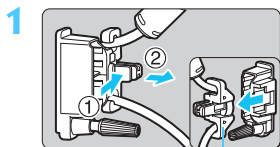

Clamp

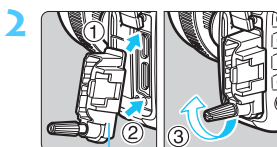

Cable protector

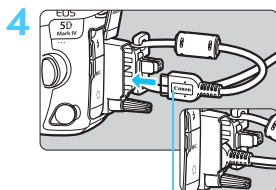
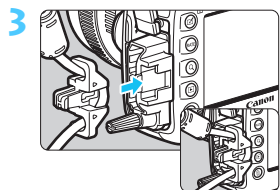

Provided interface cable

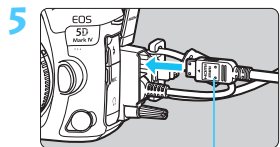

HDMI cable (sold separately)

### Using a Genuine Interface Cable (sold separately)

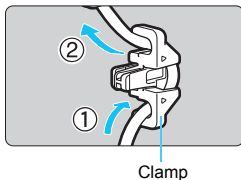

If you use a genuine interface cable (sold separately, p.525), run the cable through the clamp before attaching the clamp to the cable protector.



- Connecting interface cable without using the cable protector may damage the digital terminal.
- Do not use a USB 2.0 cable equipped with a Micro-B plug. It may damage the camera's digital terminal.
- As shown in the lower-right illustration for step 4, check that the interface cable is securely attached to the digital terminal.



To connect the camera to a TV set, using HDMI Cable HTC-100 (sold separately) is recommended. Using the cable protector is also recommended when connecting an HDMI cable.





# 1

## **Getting Started and Basic Camera Operations**

This chapter explains preparatory steps before you start shooting and the basic camera operations.

# Charging the Battery

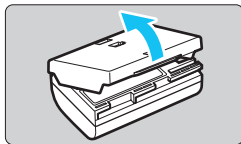

## 1 Remove the protective cover.

- Detach the protective cover provided with the battery.

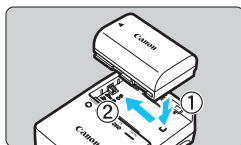

## 2 Attach the battery.

- As shown in the illustration, attach the battery securely to the charger.
- To detach the battery, follow the above procedure in reverse.

### LC-E6

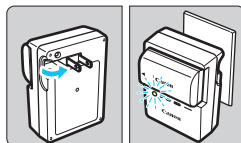

## 3 Recharge the battery.

### For LC-E6

- As shown by the arrow, flip out the battery charger's prongs and insert the prongs into a power outlet.

### LC-E6E

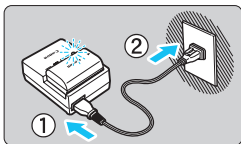

### For LC-E6E

- Connect the power cord to the charger and insert the plug into a power outlet.
- ▶ Recharging starts automatically and the charge lamp blinks in orange.

Charge Level	Charge Lamp	
	Color	Display
0-49%	Orange	Blinks once per second
50-74%		Blinks twice per second
75% or higher		Blinks three times per second
Fully charged	Green	Lights up

- It takes approx. 2 hr. and 30 min. to fully recharge a completely exhausted battery at room temperature (23°C / 73°F). The time required to recharge the battery will vary greatly depending on the ambient temperature and the battery's remaining capacity.
- For safety reasons, recharging in low temperatures (5°C - 10°C / 41°F - 50°F) will take longer (up to approx. 4 hr.).

## Tips for Using the Battery and Charger

- **Upon purchase, the battery is not fully charged.**  
Charge the battery before use.
- **Recharge the battery on the day before or on the day it is to be used.**  
Even during storage, a charged battery will gradually drain and lose its capacity.
- **After recharging the battery, detach it and disconnect the charger from the power outlet.**

- **You can attach the cover in a different orientation to indicate whether the battery is recharged or not.**

If the battery is recharged, attach the cover so that the battery-shaped hole  is aligned over the blue sticker on the battery. If the battery is exhausted, attach the cover in the opposite orientation.



- **When not using the camera, remove the battery.**  
If the battery is left in the camera for a prolonged period, a small amount of power current will keep released, resulting in excess discharge and shorter battery life. Store the battery with the protective cover attached. Storing the battery when it is fully charged may lower the battery performance.
- **The battery charger can also be used in foreign countries.**  
The battery charger is compatible with a 100 V AC to 240 V AC 50/60 Hz power source. If necessary, attach a commercially-available plug adapter for the respective country or region. Do not attach any portable voltage transformer to the battery charger. Doing so may damage the battery charger.
- **If the battery becomes exhausted quickly even after having been fully charged, the battery has reached the end of its service life.**  
Check the battery's recharge performance (p.526) and purchase a new battery.



- After disconnecting the charger's power plug, do not touch the prongs for approx. 10 sec.
- If the battery's remaining capacity (p.526) is 94% or higher, the battery will not be recharged.
- The provided charger cannot charge any battery other than Battery Pack LP-E6N/LP-E6.

# Installing and Removing the Battery

Load a fully-charged Battery Pack LP-E6N (or LP-E6) into the camera. The camera's viewfinder becomes bright when a battery is installed, and darkens when the battery is removed. If the battery is not installed, the image in the viewfinder becomes blurred and you cannot perform focusing.

## Installing the Battery

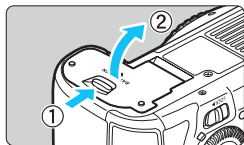

### 1 Open the cover.

- Slide the lever as shown by the arrows and open the cover.

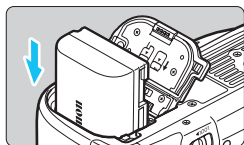

### 2 Insert the battery.

- Insert the end with the electrical contacts.
- Insert the battery until it locks in place.

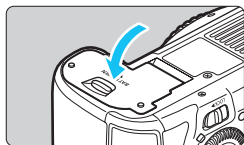

### 3 Close the cover.

- Press the cover until it snaps shut.

 You cannot use batteries other than the Battery Pack LP-E6N or LP-E6.

## Removing the Battery

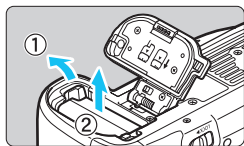

### Open the cover and remove the battery.

- Press the battery lock lever as shown by the arrow and remove the battery.
- To prevent short circuiting, be sure to attach the provided protective cover (p.42) to the battery.

# Installing and Removing the Card

You can use a CF card and an SD card with this camera. **Images can be recorded when at least one card is installed in the camera.** If cards are inserted in both slots, you can select which card to record images to or can record the same images simultaneously on both cards (p.166-168).

**If you use an SD card, make sure the card's write-protect switch is set upward to enable writing/erasing.**

## Installing the Card

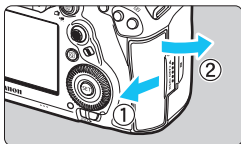

### 1 Open the cover.

- Slide the cover as shown by the arrows to open it.

CF card (Card 1)

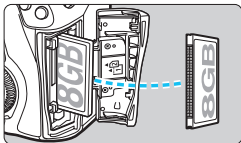

### 2 Insert the card.

- The camera-front side slot is for a CF card, and the camera-back side slot is for an SD card.
- The CF card is [1] (Card 1) and the SD card is [2] (Card 2).
- **With the CF card's label side facing you, insert the end with the small holes into the camera. If the card is inserted in the wrong way, it may damage the camera.**
- ▶ The CF card eject button (gray) will stick out.

SD card (Card 2)

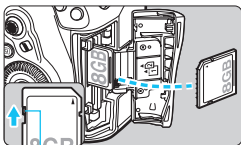

Write-protect switch

- **With the SD card's label facing you, push in the card until it clicks in place.**

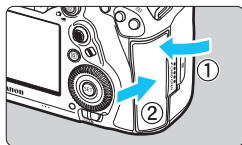

### 3 Close the cover.

- Close the cover and slide it in the direction shown by the arrows until it snaps shut.
- ▶ When you set the power switch to <ON> (p.49), the number of possible shots and the loaded card(s) will be displayed on the LCD panel.

**The images will be recorded to the card indicated by the arrow <▶> icon.**

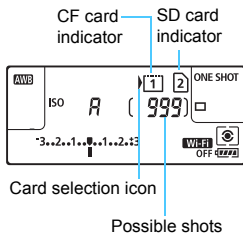

- **Type II CF cards, hard disk-type cards or CFast cards cannot be used.**
- Multimedia cards (MMC) cannot be used (card error will be displayed).



- Ultra DMA (UDMA) CF cards can also be used with the camera. UDMA cards enable faster data writing.
- SD, SDHC, and SDXC memory cards are supported. UHS-I SDHC or SDXC memory cards can also be used.
- The number of possible shots varies depending on the remaining capacity of the card, the settings of image-recording quality, ISO speed, etc.
- Setting [**1: Release shutter without card**] to [**Disable**] will prevent you from forgetting to insert a card (p.540).

## Removing the Card

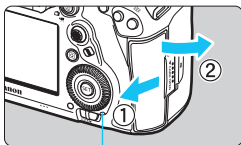

Access lamp

### 1 Open the cover.

- Set the power switch to **<OFF>**.
- **Check that the access lamp is off, then open the cover.**
- If [**Recording...**] is displayed on the LCD monitor, close the cover.

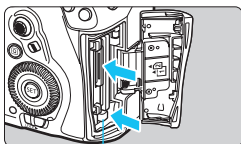

CF card eject button

### 2 Remove the card.

- To remove the CF card, push the eject button.
- To remove the SD card, push it in gently and release it. Then pull it out.
- Pull the card straight out, then close the cover.

### Caution

**During Live View shooting or movie shooting, if the red  icon appears, do not remove the card right away.** The card may be hot due to the camera's high internal temperature. Set the power switch to **<OFF>** and stop shooting for a while. Then remove the card. If you take out the card while it is still hot after shooting, you may drop the card and damage it. Be careful when taking out the card.



- **When the access lamp is lit or blinking, it indicates that images are being written to, read from, or erased from the card, or data is being transferred. Do not open the card slot cover during this time. Also, never do any of the following while the access lamp is lit or blinking. Otherwise, it can damage the image data, card, or camera.**
  - **Removing the card.**
  - **Removing the battery.**
  - **Shaking or banging the camera around.**
  - **Unplugging and connecting a power cord** (when household power outlet accessories (sold separately, p.530) are used).
- If the card already contains recorded images, the image number may not start from 0001 (p.223).
- If a card-related error message is displayed on the LCD monitor, remove and reinsert the card. If the error persists, use a different card. If you can transfer images on the card to a computer, transfer all the images and then format the card with the camera (p.73). The card may then return to normal.
- Do not touch the SD card's contacts with your fingers or metal objects. Do not expose the contacts to dust or water. If smudges adhere to the contacts, contact failure may result.









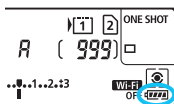

## Battery Level Indicator

When the power switch is set to <ON>, the battery level will be indicated in one of six levels. A blinking battery icon < > indicates that the battery will soon be exhausted.



Display			
Level (%)	100 - 70	69 - 50	49 - 20
Display			
Level (%)	19 - 10	9 - 1	0

## Number of Possible Shots with Viewfinder Shooting

(Approx. number of shots)

Temperature	Room Temperature (23°C / 73°F)	Low Temperatures (0°C / 32°F)
Possible shots	900	850

- The figures above are based on a fully-charged Battery Pack LP-E6N, no Live View shooting, and CIPA (Camera & Imaging Products Association) testing standards.
- With Battery Grip BG-E20 (sold separately) loaded with two LP-E6N battery packs, the number of possible shots will be approximately doubled.

- Doing any of the following will exhaust the battery faster:
  - Pressing the shutter button halfway for a prolonged period.
  - Activating the AF frequently without taking a picture.
  - Using the lens's Image Stabilizer.
  - Using the LCD monitor frequently.
- The number of possible shots may decrease depending on the actual shooting conditions.
- The lens operation is powered by the camera's battery. Certain lenses may exhaust the battery faster than others.
- In low ambient temperatures, shooting may not be possible even with a sufficient battery level.

- For the number of possible shots with Live View shooting, see page 299.
- See [**F3: Battery info.**] to check the battery condition (p.526).

## MENU Setting the Date, Time, and Zone

When you turn on the power for the first time or if the date/time/zone have been reset, the date/time/zone setting screen will appear. Follow the steps below to set the time zone first. Set the camera to the time zone in which you currently live so that, when you travel, you can simply change the setting to the correct time zone for your destination, and the camera will automatically adjust the date/time.

**Note that the date/time appended to recorded images will be based on this date/time setting. Be sure to set the correct date/time.**

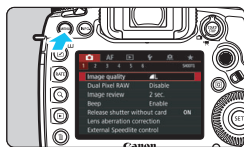

### 1 Display the menu screen.

- Press the <MENU> button to display the menu screen.

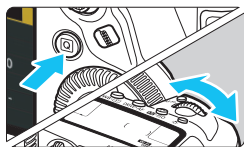

### 2 Under the [Q] tab, select [Date/Time/Zone].

- Press the <Q> button and select the [Q] tab.
- Turn the <MODE DIAL> dial to select the [2] tab.
- Turn the <SET DIAL> dial to select [Date/Time/Zone], then press <SET>.

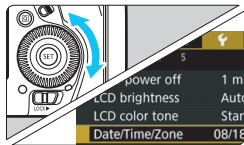

### 3 Set the time zone.

- [London] is set by default.
- Turn the <SET DIAL> dial to select [Time zone], then press <SET>.



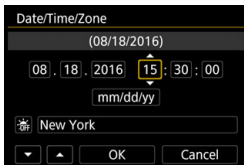
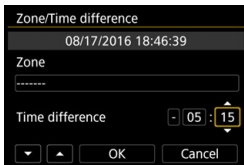
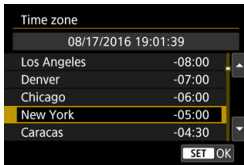
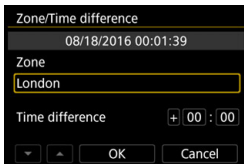

- Turn the <⊙> dial to select the frame below **[Zone]**, then press <⊙SET>.
  
- Turn the <⊙> dial to select the time zone, then press <⊙SET>.
- If your desired time zone is not listed, press the <MENU> button, then proceed to the next step to set it (with the time difference from the Coordinated Universal Time, UTC).
- To set the time difference from UTC, turn the <⊙> dial and select (+/- hour/minute) for **[Time difference]**.
- Press <⊙SET> so <⊙> is displayed.
- Turn the <⊙> dial to set it, then press <⊙SET> (Returns to <□>).
- After entering the time zone and time difference, turn the <⊙> dial to select **[OK]**, then press <⊙SET>.

## 4 Set the date and time.

- Turn the <⊙> dial to select an item.
- Press <⊙SET> so <⊙> is displayed.
- Turn the <⊙> dial to set it, then press <⊙SET> (Returns to <□>).

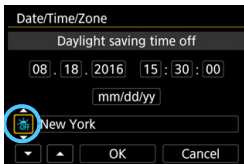

## 5 Set the daylight saving time.

- Set it if necessary.
- Turn the <☀> dial to select [**☀**].
- Press <SET> so <☀> is displayed.
- Turn the <☀> dial to select [**☀**], then press <SET>.
- When the daylight saving time is set to [**☀**], the time set in step 4 will advance by 1 hr. If [**☀**] is set, the daylight saving time will be canceled and the time will go back by 1 hr.

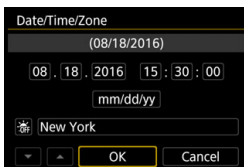

## 6 Exit the setting.

- Turn the <☀> dial to select [**OK**], then press <SET>.
- ▶ The date/time/zone and daylight saving time will be set and the menu will reappear.



- The date/time/zone settings may be reset when the camera is stored without the battery, when its battery becomes exhausted, or when it is exposed to below freezing temperatures for a prolonged period. If this happens, set the date/time/zone again.
- After changing [**Zone/Time difference**], check that the correct date/time are set.



- The date/time that were set will start from when you select [**OK**] in step 6.
- In step 3, the time displayed in [**Time zone**] is the time difference compared with Coordinated Universal Time (UTC).
- Even if [**☿2: Auto power off**] is set to [**1 min.**], [**2 min.**], or [**4 min.**], the auto power off time will be approx. 6 min. when the [**☿2: Date/Time/Zone**] setting screen is displayed.
- Automatic time update is possible with GPS function (p.237).

## MENU Selecting the Interface Language

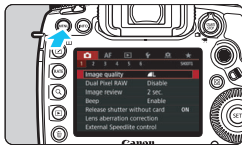

### 1 Display the menu screen.

- Press the <MENU> button to display the menu screen.

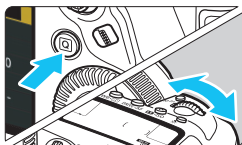

### 2 Under the [Fn] tab, select [Language].

- Press the <Q> button and select the [Fn] tab.
- Turn the <Q/Menu> dial to select the [Fn] tab.
- Turn the <Q/Menu> dial to select [Language], then press <SET>.

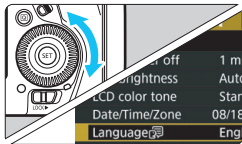

### 3 Set the desired language.

- Turn the <Q/Menu> dial to select the language, then press <SET>.
- ▶ The interface language will change.



# Attaching and Detaching a Lens

The camera is compatible with all Canon EF lenses. **The camera cannot be used with EF-S or EF-M lenses.**

## Attaching a Lens

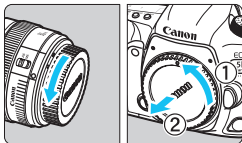

### 1 Remove the caps.

- Remove the rear lens cap and the body cap by turning them as shown by the arrows.

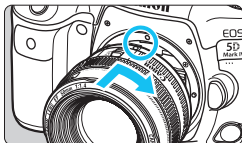

### 2 Attach the lens.

- Align the red mount index on the lens with the red mount index on the camera and turn the lens as shown by the arrow until it clicks in place.

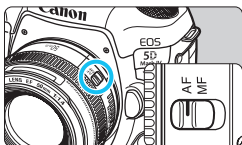

### 3 Set the lens's focus mode switch to <AF>.

- <AF> stands for autofocus.
- <MF> stands for manual focus. Autofocus will not operate.

### 4 Remove the front lens cap.

## Detaching the Lens

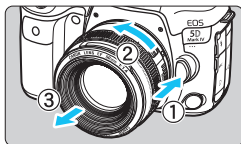

**While pressing the lens release button, turn the lens as shown by the arrow.**

- Turn the lens until it stops, then detach it.
- Attach the rear lens cap to the detached lens.

- Do not look at the sun directly through any lens. Doing so may cause loss of vision.
- When attaching or detaching a lens, set the camera's power switch to **<OFF>**.
- If the front part (focusing ring) of the lens rotates during autofocus, do not touch the rotating part.

### Minimizing Dust

- When changing lenses, do it quickly in a place with minimal dust.
- When storing the camera without a lens attached, be sure to attach the body cap to the camera.
- Remove dust on the body cap before attaching it.



# Basic Shooting Operations

## Adjusting the Viewfinder Clarity

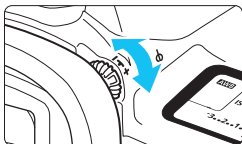

### Turn the dioptic adjustment knob.

- Turn the knob left or right so that the AF points in the viewfinder look sharp.
- If the knob is difficult to turn, remove the eyecup (p.278).



If the camera's dioptic adjustment still cannot provide a sharp viewfinder image, using Dioptic Adjustment Lens Eg (sold separately) is recommended.

## Holding the Camera

To obtain sharp images, hold the camera still to minimize camera shake.

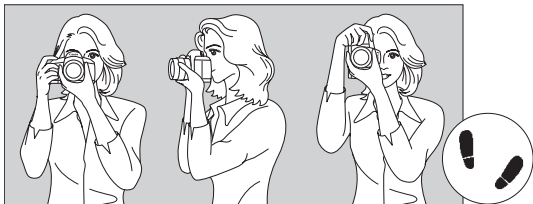

Horizontal shooting

Vertical shooting

1. Wrap your right hand around the camera grip firmly.
2. Hold the lens bottom with your left hand.
3. Rest your right index finger lightly on the shutter button.
4. Press your arms and elbows lightly against the front of your body.
5. To maintain a stable stance, place one foot slightly ahead of the other.
6. Press the camera against your face and look through the viewfinder.



To shoot while looking at the LCD monitor, see page 297.

## Shutter Button

The shutter button has two steps. You can press the shutter button halfway. Then you can further press the shutter button completely.

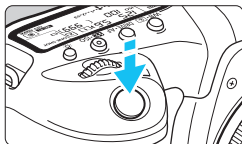

### Pressing Halfway

This activates autofocus and the automatic exposure system that sets the shutter speed and aperture.

The exposure setting (shutter speed and aperture) is displayed in the viewfinder and on the LCD panel for approx. 4 sec. (metering timer/  $\odot$ 4).

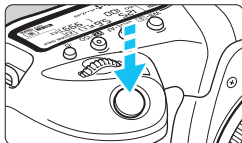

### Pressing Completely

This releases the shutter and takes the picture.

### ● Preventing Camera Shake

Hand-held camera movement during the moment of exposure is called camera shake. It can cause blurred pictures. To prevent camera shake, note the following:

- Hold and steady the camera as shown on the preceding page.
- Press the shutter button halfway to autofocus, then slowly press the shutter button completely.

- In the <P> <Tv> <Av> <M> <B> shooting modes, pressing the <AF-ON> button will be the same as pressing the shutter button halfway.
- If you press the shutter button completely without pressing it halfway first, or if you press the shutter button halfway and then press it completely immediately, the camera will take a moment before it takes the picture.
- Even during menu display or image playback, you can go back to shooting-ready state by pressing the shutter button halfway.

## Mode Dial

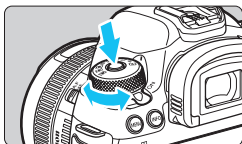



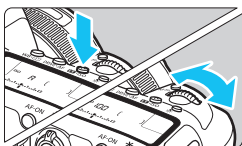

**Turn the dial while holding down the lock release button at the center of the dial.**

Use it to set the shooting mode.

## Main Dial



- (1) **After pressing a button, turn the < > dial.**

When you press a button such as <WB•>, <DRIVE•AF>, or <•ISO>, the respective function remains selectable for approx. 6 sec. ()6). During this time, you can turn the < > dial to change the setting.

When the timer ends or if you press the shutter button halfway, the camera will go back to shooting-ready state.

- Use this dial to select the metering mode, AF operation, ISO speed, AF point, etc.

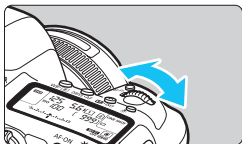

- (2) **Turn only the < > dial.**

While looking at the viewfinder or LCD panel, turn the < > dial to change the setting.

- Use this dial to set the shutter speed, aperture, etc.



The operations in (1) can be performed even when the <LOCK▶> switch is set to the right (Multi function lock, p.62).

## Quick Control Dial

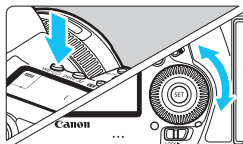

### (1) After pressing a button, turn the dial.

When you press a button such as **<WB>**, **<DRIVE>**, or **<ISO>**, the respective function remains selectable for approx. 6 sec. (6). During this time, you can turn the  dial to change the setting.

When the timer ends or if you press the shutter button halfway, the camera will go back to shooting-ready state.

- Use this dial to select the white balance, drive mode, flash exposure compensation, AF point, etc.

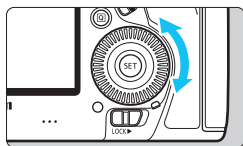



### (2) Turn only the dial.

While looking at the viewfinder or LCD panel, turn the  dial to change the setting.

- Use this dial to set the exposure compensation amount, the aperture setting for manual exposures, etc.

 The operations in (1) can be performed even when the **<LOCK>** switch is set to the right (Multi function lock, p.62).

## Multi-controller

The  consists of an eight-direction key and a button at the center. Use your thumb to tilt the  in the desired direction.

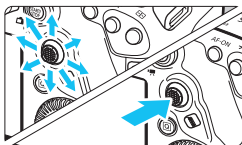



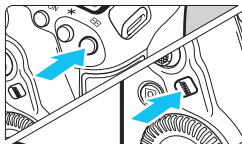

- Use it to select the AF point, correct the white balance, move the AF point or magnifying frame during Live View shooting or movie shooting, scroll around magnified images during playback, set the Quick Control, etc.
- You can also use it to select and set menu items.

## AF Area Selection Button



For selecting the AF area (p.106).



**After pressing the  button, press the  button.**

- Pressing the  button will make the AF area selection mode and AF point selectable for approx. 6 sec. (Ⓜ6). Then when you press the  (AF area selection) button within that time, you can change the AF area selection mode.



You can also press the  button and then press the  button to select the AF area selection mode.

## M-Fn Multi Function Button

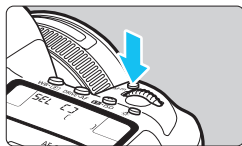

Use the <M-Fn> button for AF area selection mode (p.106), FE lock (p.286), and other functions.

To select the AF area selection mode, press the <AF-ON> button (ⓘ6), then press the <M-Fn> button.

## LOCK▶ Multi Function Lock

With [**5: Multi function lock**] set and the <LOCK▶> switch set to the right, you can prevent the settings from being inadvertently changed by such as the following: Accidentally operating Main Dial, Quick Control Dial or Multi-controller, pressing the AF area selection button or tapping on the touch screen.

For [**5: Multi function lock**] details, see page 90.

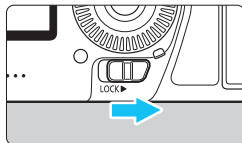

<LOCK▶> switch set to the left:

Lock released



<LOCK▶> switch set to the right:

Lock engaged

 By default, the <ⓘ6> dial will be locked when locked.

## LCD Panel Illumination



You can illuminate the LCD panel by pressing the  button. Turn on () or off the LCD panel illumination by pressing the  button.



During a bulb exposure, pressing the shutter button completely will turn off the LCD panel illumination.

## Displaying the Quick Control Screen

After you press the **<INFO.>** button a number of times (p.86), the Quick Control screen (p.88) or Custom Quick Control screen (p.510) will appear. You can then check the current shooting function settings. Pressing the **<Q>** button enables Quick Control of the shooting function settings (p.64).

Then you can press the **<INFO.>** button to turn off the screen (p.86).

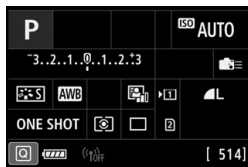

## Quick Control for Shooting Functions

You can directly select and set the shooting functions displayed on the LCD monitor with intuitive operations. This is called Quick Control. The basic operating procedures are the same for the Quick Control screen (p.88) and the Custom Quick Control screen (p.510).

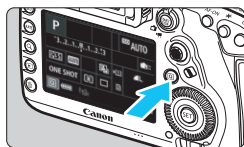

### 1 Press the **<Q>** button (◻10).

- ▶ The Quick Control screen will appear.

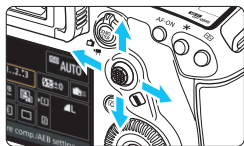

### 2 Set the desired functions.

- Use **<◻>** to select a function.
- ▶ The setting of the selected function is displayed.
- Turn the **<◻>** or **<◻>** dial to change the setting.

#### ● **<A+>** mode

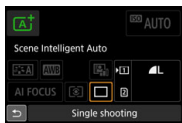

#### ● **<P>**, **<Tv>**, **<Av>**, **<M>**, **<B>** mode

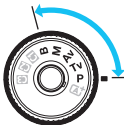

### 3 Take the picture.

- Press the shutter button completely to take the picture.
- ▶ The captured image will be displayed.

- In the **<A+>** mode with the Quick Control screen displayed, you can only set **[Rec function/card selection]**, **[Image quality]**, and **[Drive mode]**.
- You can also tap on the screen for Quick Control settings (p.70).



## Functions Settable with the Quick Control

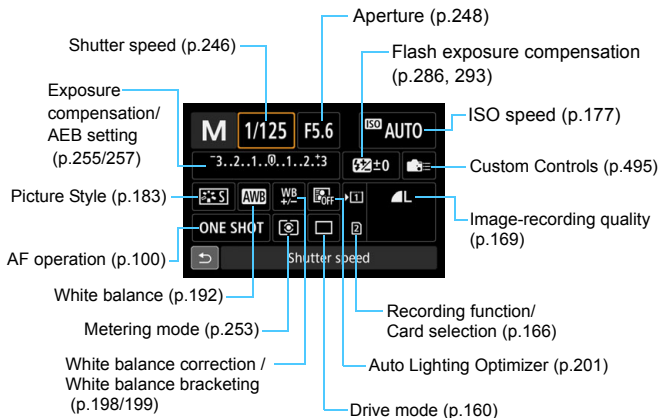

## Quick Control

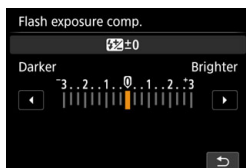
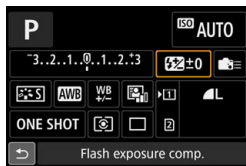

- Select the desired function and press **<SET>**. The function setting screen will appear.
- Turn the **<Sun/Star>** or **<Sun/Star>** dial to change some of the settings. There are also functions that are set by pressing the button.
- Press **<SET>** to finalize the setting and return to the previous screen.
- When you select **<Lock/Menu>** (p.495) and press the **<MENU>** button, the previous screen will reappear.

## Custom Quick Control

You can customize the layout of the Quick Control screen. This feature lets you display and position the shooting functions on the Quick Control screen as desired. This feature is called “Custom Quick Control (screen)”. For the Custom Quick Control, see page 510.

On the Custom Quick Control screen, if you press the **<Q>** button and there are no functions you can set with Quick Control, the Quick Control icon on the lower left of the screen will be displayed in orange.

## MENU Menu Operations

You can set various settings with the menus such as the image-recording quality, date/time, etc.

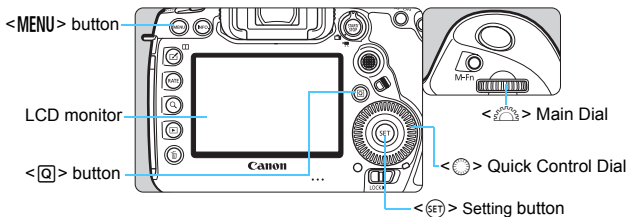

### <A+> Mode Menu Screen

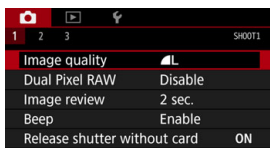

\* Certain menu tabs and menu items are not displayed in the **<A+>** mode.

### <P>, <Tv>, <Av>, <M>, <B> Mode Menu Screen

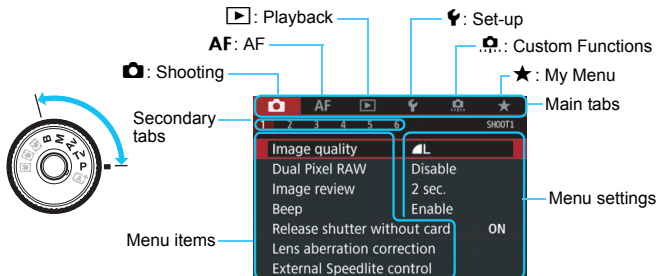

## Menu Setting Procedure

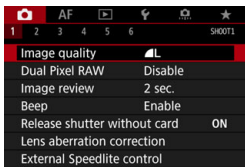

### 1 Display the menu screen.

- Press the <MENU> button to display the menu screen.

### 2 Select a tab.

- Each time you press the <Q> button, the main tab (group of functions) will switch.
- Turn the <☀> dial to select a secondary tab.
- For example, the [📷5] tab refers to the screen displayed when the 📷 (Shooting) tab's fifth box "5" from the left is selected.

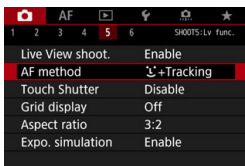

### 3 Select the desired item.

- Turn the <☀> dial to select the item, then press <SET>.

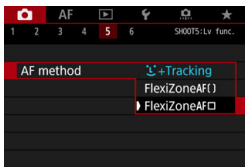

### 4 Select the setting.

- Turn the <☀> dial to select the desired setting.
- The current setting is indicated in blue.

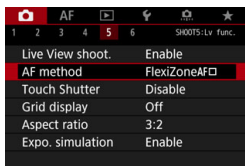

### 5 Set the setting.

- Press <SET> to set it.

### 6 Exit the setting.

- Press the <MENU> button to exit the menu and return to shooting-ready.



- The explanation of menu functions hereafter assumes that you have pressed the <MENU> button to display the menu screen.
- You can also use <⏏> to select and set menu functions. (Except for [▶1: Erase images] and [⏏1: Format card].)
- To cancel the operation, press the <MENU> button.
- For details about each menu item, see page 540.

## Dimmed Menu Items

Example: Highlight tone priority

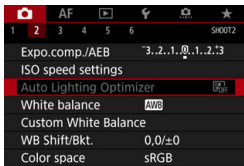

Dimmed menu items cannot be set. The menu item is dimmed if another function setting is overriding it.

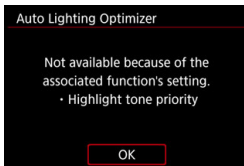

You can see the overriding function by selecting the dimmed menu item and pressing <ⓈET>.

If you cancel the overriding function's setting, the dimmed menu item will become settable.



Certain dimmed menu items may not show the overriding function.



With [⏏5: Clear all camera settings], you can reset the menu functions to the default settings (p.77).

## Operating the Camera with Touch Screen

You can operate the camera by touching the LCD monitor (touch-sensitive panel) with your fingers.

### Tap

#### Sample Display (Quick Control)

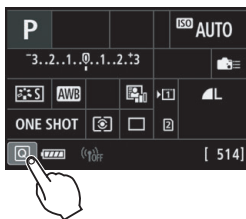

- Use your finger to tap on (touch briefly and then remove your finger from) the LCD monitor.
- By tapping, you can select menus, icons, etc., displayed on the LCD monitor.
- When touch operation is possible, a frame will appear around the icon (except on menu screens).

For example, when you tap on [Q], the Quick Control screen appears. By tapping on [↶], you can return to the preceding screen.

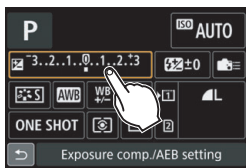

#### Operations possible by tapping on the screen

- Setting menu functions after pressing the <MENU> button.
- Quick Control
- Setting functions after pressing the <WB•[WB]•[WB]•[WB]>, <DRIVE•AF>, <[ISO]•ISO>, or <[WB]•[WB]•[WB]•[WB]> button
- Touch AF in Live View shooting and movie shooting
- Touch shutter in Live View shooting
- Setting functions in Live View shooting and movie shooting
- Playback operations

If [📷1: Beep] is set to [Touch to 🔊], the beep will not sound for touch operations (p.76).

## Drag

### Sample Display (Menu screen)

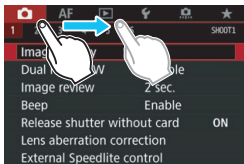

- Slide your finger while touching the LCD monitor.

### Sample Display (Scale display)

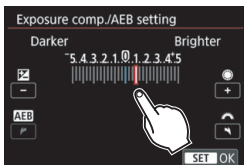

### Operations possible by dragging your finger on the screen

- Selecting a menu tab or item after pressing the <MENU> button
- Setting with scale display
- Quick Control
- Selecting AF points
- Playback operations

## MENU Touch Control Settings



### 1 Select [Touch control].

- Under the [**Touch control**] tab, select [**Touch control**], then press <[**SET**]>.

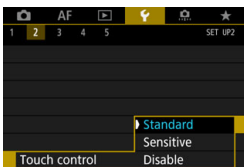

### 2 Set the touch control sensitivity setting.

- Select the desired setting, then press <[**SET**]>.
- [**Standard**] is the normal setting.
- [**Sensitive**] provides a more reactive touch screen response than [**Standard**]. Try using both settings and select the one you prefer.
- To disable touch operations, select [**Disable**].

## ⚠ Cautions for Touch Control Operations

- Since the LCD monitor is not pressure sensitive, do not use any sharp objects, such as your fingernail or a ballpoint pen, for touch operations.
- Do not use wet fingers for touch operations.
- If the LCD monitor has any moisture or if your fingers are wet, the touch screen may not respond or malfunction may occur. In such a case, turn off the power and wipe off the moisture with a cloth.
- Attaching any commercially-available protective sheet or sticker on the LCD monitor may degrade the touch operation response.
- If you quickly perform touch operation when [**Sensitive**] is set, the touch operation response may be slower.



# Before You Start

## **MENU** Formatting the Card

If the card is new or was previously formatted by another camera or computer, format the card with this camera.

**When the card is formatted, all images and data on the card will be erased. Even protected images will be erased, so make sure there is nothing you need to keep. If necessary, transfer the images and data to a computer, etc., before formatting the card.**

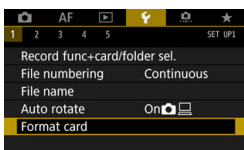

### 1 Select [Format card].

- Under the [**1**] tab, select [**Format card**], then press <[SET]>.

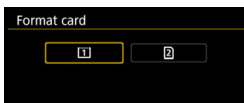

### 2 Select the card.

- [**1**] is the CF card, and [**2**] is the SD card.
- Select the card, then press <[SET]>.

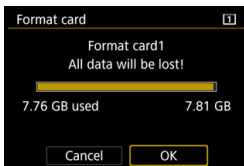

### 3 Format the card.

- Select [**OK**], then press <[SET]>.
- The card will be formatted.

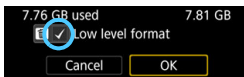

- When [**2**] is selected, low-level formatting is possible (p.74). For low-level formatting, press the <[trash]> button to add a checkmark [✓] to [**Low level format**], then select [**OK**].



## Format the card in the following cases:

- The card is new.
- The card was formatted by a different camera or a computer.
- The card is full of images or data.
- A card-related error is displayed (p.573).

### Low-level Formatting

- Perform low-level formatting if the SD card's reading or writing speed seems slow or if you want to totally erase the data on the card.
- Since low-level formatting will erase all recordable sectors on the SD card, the formatting will take longer than normal formatting.
- You can stop the low-level formatting by selecting [**Cancel**]. Even in this case, normal formatting will be completed and you can use the SD card as usual.

- **Card's file formats**

CF cards up to 128 GB in capacity and SD/SDHC cards will be formatted in FAT32. CF cards exceeding 128 GB and SDXC cards will be formatted in exFAT.

When shooting a movie with a card formatted in exFAT, the movie will be recorded in a single file (instead of being split into multiple files) even if it exceeds 4 GB. (The movie file will exceed 4 GB.)



- If you format a CF card exceeding 128 GB or SDXC card with this camera and then insert it into another camera, an error may be displayed and the card may become unusable. Certain computer operating systems or card readers may not recognize a card formatted in exFAT.
- When the card is formatted or data is erased, only the file management information is changed. The actual data is not completely erased. Be aware of this when selling or discarding the card. When discarding the card, perform low-level formatting or destroy the card physically to prevent personal data from being leaked.



- The card capacity displayed on the card format screen may be smaller than the capacity indicated on the card.
- This device incorporates exFAT technology licensed from Microsoft.

## MENU Disabling the Beeper

You can prevent the beeper from sounding when focus is achieved, during self-timer shooting, and during touch operations.

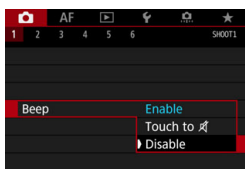

### 1 Select [Beep].

- Under the [ 1] tab, select **[Beep]**, then press <SET>.

### 2 Select [Disable].

- Select **[Disable]**, then press <SET>.
- The beeper will not sound.
- If **[Touch to ]** is selected, the beeper will be silent only for touch operations.

## MENU Setting the Power-off Time/Auto Power Off

To save battery power, the camera turns off automatically after a set time of idle operation elapses. The default setting is 1 min., but this setting can be changed. If you do not want the camera to turn off automatically, set this to **[Disable]**. After the power turns off, you can turn on the camera again by pressing the shutter button or other buttons.

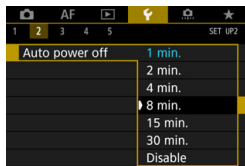

### 1 Select [Auto power off].

- Under the [ 2] tab, select **[Auto power off]**, then press <SET>.

### 2 Set the desired time.

- Select the desired setting, then press <SET>.

Even if **[Disable]** is set, the LCD monitor will turn off automatically after approx. 30 min. to save power. (The camera's power does not turn off.)

## MENU Setting the Image Review Time

You can set how long the image is displayed on the LCD monitor immediately after shooting. To keep the captured image displayed, set **[Hold]**. To not have the captured image displayed, set **[Off]**.

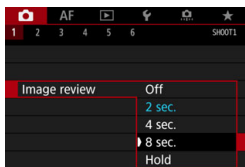

### 1 Select **[Image review]**.

- Under the [**1**] tab, select **[Image review]**, then press **<SET>**.

### 2 Set the desired time.

- Select the desired setting, then press **<SET>**.



If **[Hold]** is set, the image will be displayed until the auto power off time elapses.

## MENU Reverting the Camera to the Default Settings <sup>☆</sup>

The camera's shooting function settings and menu settings can be reverted to their defaults.

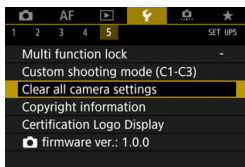

### 1 Select **[Clear all camera settings]**.

- Under the [**5**] tab, select **[Clear all camera settings]**, then press **<SET>**.

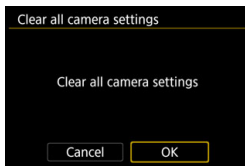

### 2 Select **[OK]**.

- ▶ Clearing all the camera settings will reset the camera to the default settings on pages 78-80.



For how to clear all the Custom Function settings, see page 481.

## Shooting Function Settings

AF operation	One-Shot AF
AF area selection mode	Single-point AF (Manual selection)
AF point selection	Center
Registered AF point	Canceled
Metering mode	 (Evaluative metering)
ISO speed settings	
ISO speed	Automatic setting (Auto)
Range for stills	Minimum: 100 Maximum: 32000
Auto range	Minimum: 100 Maximum: 12800
Minimum shutter speed for auto	Auto
Drive mode	<input type="checkbox"/> (Single shooting)
Exposure compensation/AEB	Canceled
Flash exposure compensation	Canceled
Multiple exposure	Disable
HDR mode	Disable HDR
Interval timer	Disable
Bulb timer	Disable
Anti-flicker shooting	Disable
Mirror lockup	Disable
Viewfinder Information	
Electronic level	Hide
Grid display	Hide
Show/hide in viewfinder	Only flicker detection selected
Custom Functions	Unchanged
External Speedlite control	
Flash firing	Enable
E-TTL II flash metering	Evaluative flash metering
Flash sync. speed in Av mode	Auto

## AF

Case 1 - 6	Case1/Parameter settings of all cases cleared
AI Servo 1st image priority	Equal priority
AI Servo 2nd image priority	Equal priority
Lens electronic MF	Enable after One-Shot AF
AF-assist beam firing	Enable
One-Shot AF release priority	Focus priority
Lens drive when AF impossible	Continue focus search
Selectable AF point	All points
Select AF area selection mode	All items selected
AF area selection method	M-Fn button
Orientation linked AF point	Same for both vertical/horizontal
Initial AF Point,  AI Servo AF	Auto
Auto AF pt sel.: EOS iTR AF	EOS iTR AF (Face priority)
AF point selection movement	Stops at AF area edges
AF point display during focus	Selected (constant)
VF display illumination	Auto
AF point during AI Servo AF	Disable
AF operation display in viewfinder	Displayed in viewfinder
AF Microadjustment	Disable/ Adjustment amount retained

## Image Recording Settings

Image quality	L
Dual Pixel RAW	Disable
Picture Style	Standard
Auto Lighting Optimizer	Standard
Lens aberration correction	
Peripheral illumination correction	Enable
Distortion correction	Disable
Digital Lens Optimizer	Disable
Chromatic aberration correction	Enable
Diffraction	Enable
White balance	(Ambience priority)
Custom White Balance	Canceled
White balance shift	Canceled
White balance bracketing	Canceled
Color space	sRGB
Long exposure noise reduction	Disable
High ISO speed noise reduction	Standard
Highlight tone priority	Disable
Record function+card/folder selection	
Record function	Standard
Record and playback	Unchanged
File numbering	Continuous
File name	Preset code
Dust Delete Data	Erased

## Camera Settings

Image review time	2 sec.
Beep	Enable
Release shutter without card	Enable
Image jump w/	(10 images)
Highlight alert	Disable
AF point display	Disable
Playback grid	Off
Histogram display	Brightness
Movie playback count	Unchanged
Magnification (Approx.)	2x (magnify from center)
Control over HDMI	Disable
Auto rotate vertical images	On
Auto power off	1 min.
LCD brightness	Auto
LCD color tone	2: Standard
Date/Time/Zone	Unchanged
Language	Unchanged
Touch control	Standard
Video system	Unchanged
Auto cleaning	Enable
button display options	All items selected
Custom Quick Control	Unchanged
button LV display options	Unchanged
button function	Rating
GPS	Disable
Built-in wireless setting	
Wi-Fi/NFC	Disable
FTP transfer setting	
Automatic transfer	Disable
Multi function lock	(Quick Control Dial) only
Custom shooting mode	Unchanged
Copyright information	Unchanged
Configure: MY MENU	Unchanged
Menu display	Normal display

## Live View Shooting Settings

Live View shooting	Enable
AF method	☺ +Tracking
Touch shutter	Disable
Grid display	Off
Aspect ratio	3:2
Exposure simulation	Enable
Silent LV shooting	Mode 1
Metering timer	8 sec.

## Movie Shooting Settings

ISO speed settings	
ISO speed	Automatic setting (Auto)
Range for movies	Minimum: 100 Maximum: 25600
Range for 4K	Minimum: 100 Maximum: 12800
Movie Servo AF	Enable
AF method	☺ +Tracking
Grid display	Off
Movie recording quality	
MOV/MP4	MOV
Movie recording size	NTSC: FHD 29.97P IPB PAL: FHD 25.00P IPB
24.00P	Disable
High Frame Rate	Disable
Sound recording	Auto
Wind filter	Disable
Attenuator	Disable

Movie Servo AF Speed	
When active	Always on
AF speed	0 (Standard)
Movie Servo AF track sensitivity	0
Metering timer	8 sec.
Time code	
Count up	Unchanged
Start time setting	Unchanged
Movie recording count	Unchanged
Movie playback count	Unchanged
HDMI	Unchanged
Drop frame	Unchanged
button function	☺ AF/-
Time-lapse movie	Disable
HDMI display	☐
HDMI frame rate	Auto
Remote control shooting	Disable



## # Displaying the Grid in the Viewfinder

You can display a grid in the viewfinder to help you check the camera tilt or compose the shot.

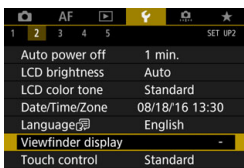

- 1 **Select [Viewfinder display].**
  - Under the [**2**] tab, select **[Viewfinder display]**, then press **<SET>**.

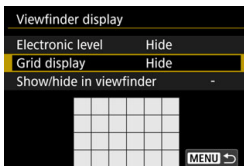

- 2 **Select [Grid display].**



- 3 **Select [Show].**
  - When you exit the menu, the grid will appear in the viewfinder.

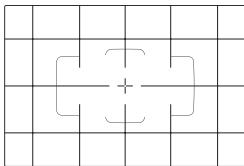

 You can display a grid on the LCD monitor during Live View shooting and before you start shooting a movie (p.309, 382).

## Displaying the Electronic Level

You can display the electronic level on the LCD monitor and in the viewfinder to help you correct the camera tilt.

### Displaying the Electronic Level on the LCD Monitor

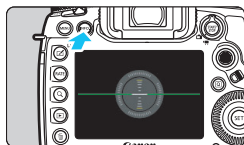

#### 1 Press the <INFO.> button.

- Each time you press the <INFO.> button, the screen display will change.
- Display the electronic level.
- If the electronic level does not appear, set [**Y** 3: **INFO** button display options] so that the electronic level can be displayed (p.86).

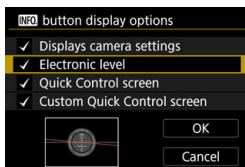

#### 2 Check the camera's tilt.

- The horizontal and vertical tilts are displayed in 1° increments.
- When the red line turns green, it indicates that the tilt is almost corrected.

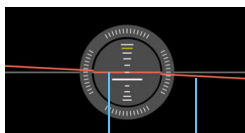

Vertical level Horizontal level

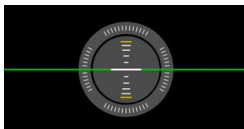

- Even when the tilt is corrected, there may be a margin of error of approx.  $\pm 1^\circ$ .
- If the camera is very tilted, the electronic level's margin of error will be larger.

 During Live View shooting and before movie shooting, you can also display the electronic level as described above (except with **L**+ Tracking).

## MENU Displaying the Electronic Level in the Viewfinder

An electronic level can be displayed on the upper part of the viewfinder. Since this indicator is displayed during shooting, you can take the picture while checking the camera tilt.

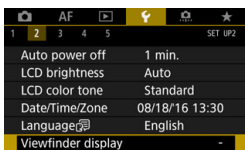

### 1 Select [Viewfinder display].

- Under the [**2**] tab, select [Viewfinder display], then press **<SET>**.



### 2 Select [Electronic level].



### 3 Select [Show].

### 4 Press the shutter button halfway.

- The electronic level will be displayed on the upper part of the viewfinder.
- This level also works with vertical shooting.

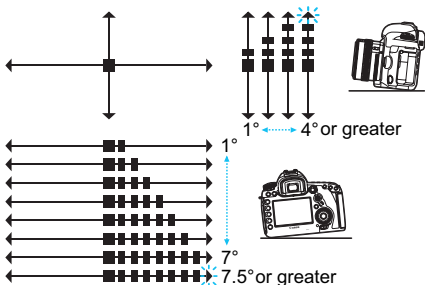

Even when the tilt is corrected, there may be a margin of error of approx.  $\pm 1^\circ$ .

## MENU Setting the Viewfinder Information Display ☆

The shooting function settings (Battery (remaining capacity), Shooting mode, White balance, Drive mode, AF operation, Metering mode, Image quality (image type), Digital Lens Optimizer, Dual Pixel RAW (shooting), Flicker detection) can be displayed in the viewfinder. By default, only Flicker detection is checkmarked [✓].

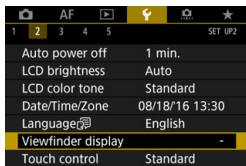

### 1 Select [Viewfinder display].

- Under the [F2] tab, select [Viewfinder display], then press <SET>.

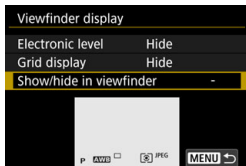

### 2 Select [Show/hide in viewfinder].

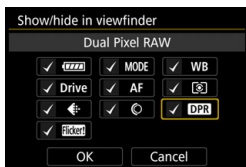





### 3 Checkmark [✓] the information to be displayed.

- Select the information to display and press <SET> to add a checkmark [✓].
- Repeat this procedure to add a checkmark [✓] to all the information to be displayed. Then select [OK].
- ▶ When you exit the menu, the checkmarked information will appear in the viewfinder (p.31).



 If no card is inserted in the camera, the image-recording quality (image type: JPEG/RAW) will not be displayed.

- 
- When you press the <WB• > or <DRIVE•AF > button, operate the lens's focus mode switch, or when a lens equipped with electronic manual focusing function is used and the AF and MF switches as the lens focusing ring is turned (p.138), the respective information will appear in the viewfinder regardless of whether it is checkmarked.
  - Even if **[Battery]** is not checkmarked, the battery check icon ( /  ) will be displayed in the viewfinder when the battery level is low.

# INFO. Button Functions

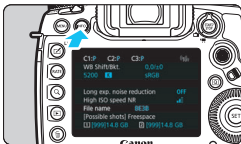

When you press the <INFO.> button with the camera being ready to shoot, you can switch the display as follows:  
 Displays camera settings (p.87),  
 Electronic level (p.82), Quick Control screen (p.88), and Custom Quick Control screen (p.510).

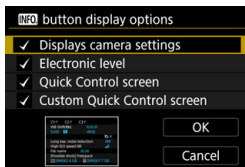

[**INFO** button display options] under [**4/3**] tab enables you to select the options displayed when the <INFO.> button is pressed.

- Select the desired display option and press <SET> to add a checkmark [✓].
- Then select [**OK**] to register the setting.

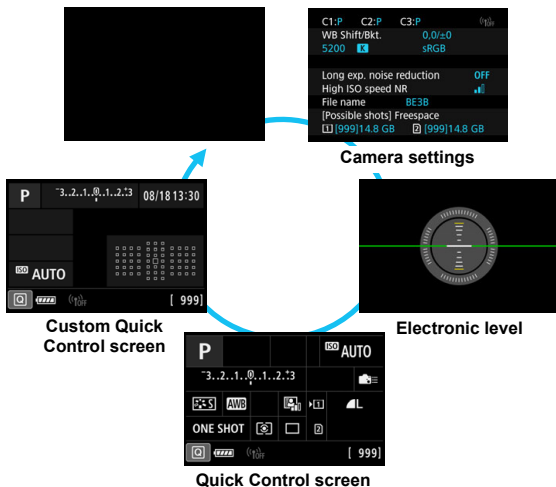



- If you turn off the power with the Electronic level, Quick Control screen, or Custom Quick Control screen displayed, the same screen will be displayed when you turn on the power again. To cancel this function, press the <INFO.> button a number of times until the screen is blank, then turn off the power switch.
- Note that you cannot remove the [✓] for all four display options.
- The [Displays camera settings] sample screen is displayed in English for all languages.
- Even if you set the [Electronic level] not to be displayed, it may still be displayed for Live View shooting and movie shooting by pressing the <INFO.> button.
- When the Quick Control screen or Custom Quick Control screen is displayed, pressing the <Q> button enables you to set a function with Quick Control (p.64).

## Camera Settings

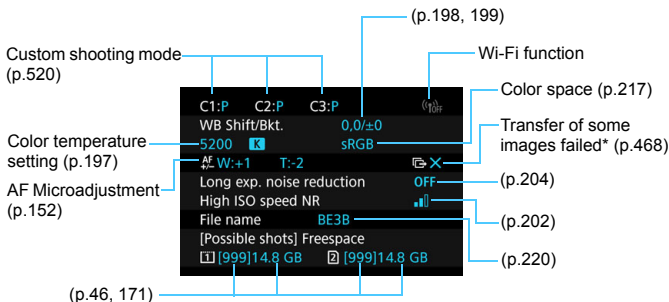

\* This icon is displayed when the transfer of some images failed.

## Quick Control Screen

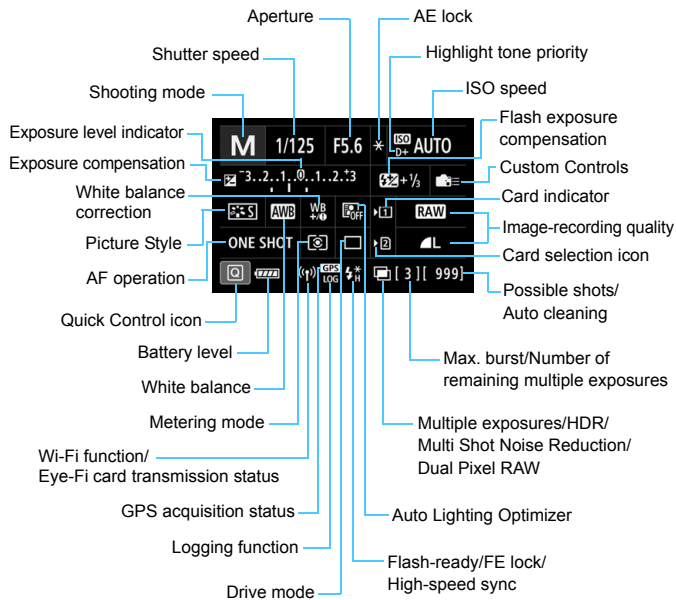



\* The display will show only the settings currently applied.

## Custom Quick Control screen

For the Custom Quick Control, see page 510.



## Button Operation for the Quick Control and Custom Quick Control Screens

When you press the <WB••ISO>, or <> button, the setting screen will appear and you can use <

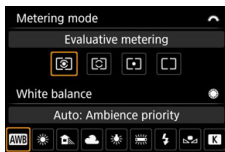

Metering mode / White balance

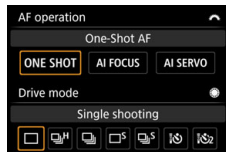

AF operation / Drive mode

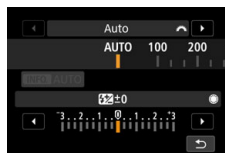

ISO speed /  
Flash exposure compensation

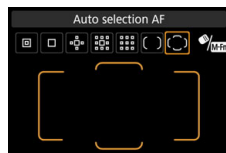

AF Area / AF point selection

## LOCK▶ Setting Multi Function Lock

By setting the <LOCK▶> switch to the right, you can prevent the settings from being inadvertently changed by such as the following: Accidentally operating Main Dial, Quick Control Dial or Multi-controller, pressing the AF area selection button or tapping on the touch screen.

For details on the Multi function lock switch, see page 62.

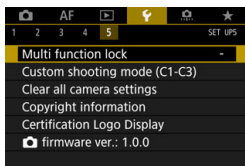

### 1 Select [Multi function lock].

- Under the [**5**] tab, select [**Multi function lock**], then press <SET>.

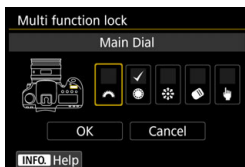

### 2 Add a checkmark [✓] to the camera control to be locked.

- Select a camera control and press <SET> to add a checkmark [✓].
- Select [**OK**].
- ▶ When the <LOCK▶> switch is set to the right, the checkmarked [✓] camera controls will be locked.

- If the <LOCK▶> switch is set to the right and you try to use one of the locked camera controls (except when [**Touch control**] is set), <L> will be displayed in the viewfinder and on the LCD panel. On the Quick Control screen (p.64), [**LOCK**] will be displayed. During Live View or movie shooting, [**LOCK**] will be displayed on the shooting screen.
- By default, the <DIAL> dial will be locked when locked.
- In the <A+> mode, only [**Touch control**] can be set.
- Quick Control (p.64) will work regardless of the Multi function lock setting.

## ? Help

When [INFO Help] is displayed at the bottom of the menu screen, the feature's description (Help) can be displayed. Press the <INFO.> button to display the Help. Press it again to turn off the Help display. If the Help fills more than one screen, a scroll bar will appear on the right edge. Turn the <🌀> dial to scroll.

### ● Example: [AF1: Case 2]

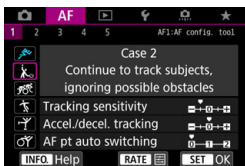

INFO.

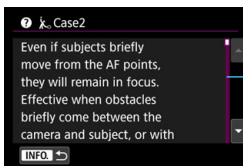

Scroll bar

### ● Example: [AF4: Orientation linked AF point]

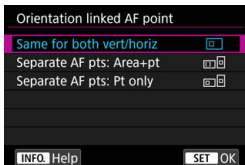

INFO.

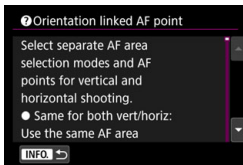

### ● Example: [🔒5: Multi function lock]



INFO.

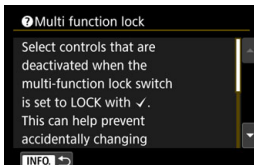



# 2

## Basic Shooting

This chapter explains how to use the Mode Dial's <A+> (Scene Intelligent Auto) mode for easy picture taking.

In the <A+> mode, all you do is point and shoot and the camera sets everything automatically (p.536). Also, to prevent botched pictures due to misoperations, advanced shooting function settings cannot be changed.

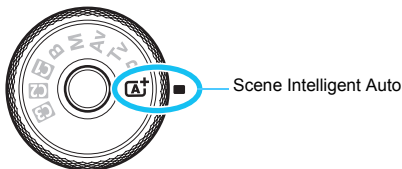

### Auto Lighting Optimizer

In the <A+> mode, the Auto Lighting Optimizer (p.201) will adjust the image automatically to obtain the optimum brightness and contrast based on the shooting result.

## **[A<sup>+</sup>]** Fully Automatic Shooting (Scene Intelligent Auto)

**<[A<sup>+</sup>]>** is a fully automatic mode. The camera analyzes the scene and sets the optimum settings automatically. It also adjusts focus automatically on either the still or moving subject by detecting the motion of the subject (p.97).



### **1 Set the Mode Dial to <[A<sup>+</sup>]>.**

- Turn the Mode Dial while holding down the lock release button at the center.

Area AF frame

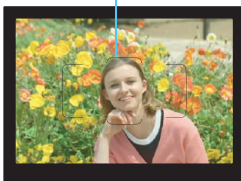

### **2 Aim the Area AF frame over the subject.**

- All the AF points will be used to focus, and the camera will focus on the closest object.
- Aiming the center of the Area AF frame over the subject will make focusing easier.

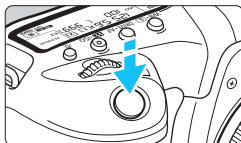

### **3 Focus on the subject.**

- Press the shutter button halfway. The lens elements will shift to focus.
- ▶ During the autofocus operation, **<AF>** will be displayed.
- ▶ The AF point that achieves focus will be displayed. At the same time, the beeper will sound and the focus indicator **<●>** will light up.
- ▶ In low light, the AF point(s) will light up briefly in red.



Focus indicator

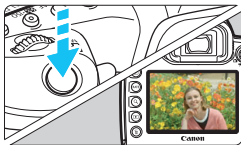

## 4 Take the picture.

- Press the shutter button completely to take the picture.
- ▶ The captured image will be displayed for approx. 2 sec. on the LCD monitor.



The **A<sup>+</sup>** mode makes the colors look more impressive in nature, outdoor, and sunset scenes. If you do not obtain the desired color tones, change the mode to **P**, **Tv**, **Av**, or **M**, set a Picture Style other than **A**, then shoot again (p.183).

## ? FAQ

- **The focus indicator <●> blinks and focus is not achieved.**  
Aim the Area AF frame over an area with good contrast, then press the shutter button halfway (p.58). If you are too close to the subject, move away and shoot again.
- **When focus is achieved, the AF points do not light up in red.**  
The AF points light up in red only when focus is achieved in low light or with a dark subject.
- **Multiple AF points light up simultaneously.**  
Focus has been achieved at all those points. You can take the picture as long as an AF point covering the target subject is lighting up.
- **The beeper continues to beep softly. (The focus indicator <●> does not light up.)**  
It indicates that the camera is focusing continuously on a moving subject. (The AF status indicator **AF** lights up, but the focus indicator <●> does not light up.) You can take sharp pictures of a moving subject.  
Note that focus lock (p.97) will not work in this case.

- **Pressing the shutter button halfway does not focus on the subject.**

If the focus mode switch of the lens is set to <MF> (manual focus), set it to <AF> (autofocus).

- **The shutter speed display is blinking.**

Since it is too dark, taking the picture may result in a blurred subject due to camera shake. Using a tripod or a Canon EX-series Speedlite (sold separately, p.286) is recommended.

- **When the external flash was used, the bottom part of the picture came out unnaturally dark.**

If a hood is attached to the lens, it may obstruct the flash light. If the subject is close, detach the hood before taking the picture with flash.



## Minimizing Blurred Photos

- Silent single shooting (p.161), Single shooting in Live View shooting, etc. are effective. Mirror lockup (p.276) is also effective except when the shooting mode is set to < >.
- For continuous shooting, using Silent continuous shooting (p.161) or Live View continuous shooting is effective.
- Use a sturdy tripod that can bear the weight of the shooting equipment. Mount the camera securely on the tripod.
- Using a remote switch or a remote controller is recommended (p.279).



## **[A<sup>+</sup>]** Full Auto Techniques (Scene Intelligent Auto) ■

### Recomposing the Shot



Depending on the scene, positioning the subject toward the left or right to include a balanced background will result in a picture with better perspective.

In the <[A<sup>+</sup>]> mode, pressing the shutter button halfway to focus on a still subject will lock the focus on that subject. Recompose the shot while keeping the shutter button pressed halfway, and then press the shutter button completely to take the picture. This is called “focus lock”.

### Shooting a Moving Subject



In the <[A<sup>+</sup>]> mode, if the subject moves (distance to camera changes) during or after focusing, AI Servo AF will take effect to focus on the subject continuously. (The beeper will continue beeping softly.) As long as you keep the Area AF frame positioned over the subject while pressing the shutter button halfway, focusing will be continuous. At the decisive moment, press the shutter button completely to take the picture.

## Live View Shooting

You can shoot while viewing the image on the LCD monitor. This is called “Live View shooting”. For details, see page 297.

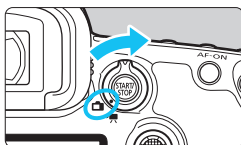

- 1 **Set the Live View shooting/Movie shooting switch to <img alt="camera icon" data-bbox="745 215 775 235"/>.**



- 2 **Display the Live View image on the LCD monitor.**

- Press the <img alt="START/STOP button icon" data-bbox="595 385 625 405"/> button.
- ▶ The Live View image will appear on the LCD monitor.



- 3 **Focus on the subject.**

- Press the shutter button halfway to focus.
- ▶ When focus is achieved, the AF point will turn green and the beeper will sound.

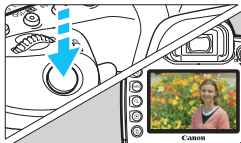

- 4 **Take the picture.**

- Press the shutter button completely.
- ▶ The picture is taken and the captured image is displayed on the LCD monitor.
- ▶ When the playback display ends, the camera will return to Live View shooting automatically.
- Press the <img alt="START/STOP button icon" data-bbox="595 825 625 845"/> button to exit the Live View shooting.

# 3

## Setting the AF and Drive Modes

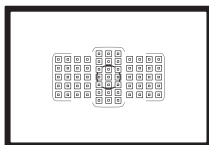

The AF points in the viewfinder are arranged to make AF shooting suitable for a wide variety of subjects and scenes.

You can also select the AF operation and drive mode that best match the shooting conditions and subject.

- A ☆ icon at the upper right of a page title indicates a function that can be used only in the following modes: <P> <Tv> <Av> <M> <B>.
- In the <A+> mode, the AF operation and AF area selection mode are set automatically.



<AF> stands for autofocus. <MF> stands for manual focus.

## AF: Selecting the AF Operation ☆

You can select the AF operation characteristics to suit the shooting conditions or subject. In the <A+> mode, "AI Focus AF" is set automatically.

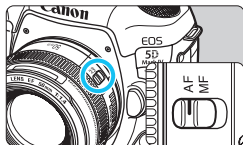

1 Set the lens's focus mode switch to <AF>.

2 Set the <P>, <Tv>, <Av>, <M>, or <B> mode.



3 Press the <DRIVE-AF> button (⦿6).

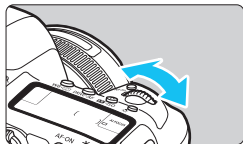

4 Select the AF operation.

- While looking at the LCD panel or in the viewfinder, turn the <⚙> dial.

**ONE SHOT**: One-Shot AF

**AI FOCUS**: AI Focus AF

**AI SERVO**: AI Servo AF

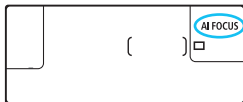

- When the AF area selection mode (p.109) is set to Zone AF, Large Zone AF, or Auto selection AF, AF is possible by utilizing the face and subject's color information (p.147).
- In the <P>, <Tv>, <Av>, <M>, and <B> shooting modes, AF is also possible by pressing the <AF-ON> button.

## One-Shot AF for Still Subjects

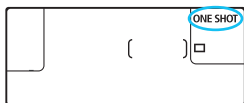
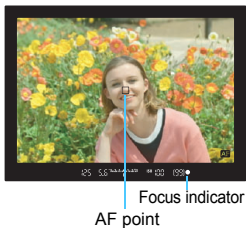

**Suited for still subjects. When you press the shutter button halfway, the camera will focus only once.**

- The AF point that achieves focus is displayed, and the focus indicator <●> in the viewfinder will also light up.
- With evaluative metering (p.253), the exposure setting will be set at the same time as focus is achieved.
- While you hold down the shutter button halfway, the focus will be locked. You can then recompose the shot if desired.



- If focus cannot be achieved, the focus indicator <●> in the viewfinder will blink. If this occurs, the picture cannot be taken even if the shutter button is pressed completely. Recompose the shot and try to focus again or see “When Autofocus Fails” (p.158).
- If [CAMERA 1: Beep] is set to [Disable], the beeper will not sound when focus is achieved.
- After achieving focus with One-Shot AF, you can lock the focus on a subject and recompose the shot. This is called “focus lock”. This is useful when you want to focus on a peripheral subject not covered by the Area AF frame.
- When a lens equipped with an electronic manual focusing function is used, after achieving focus, you can focus manually by turning the lens focusing ring while pressing the shutter button halfway (p.159).

## AI Servo AF for Moving Subjects

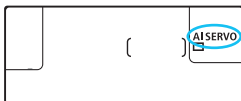

**This AF operation is suited for moving subjects when the focusing distance keeps changing. While you hold down the shutter button halfway, the camera will keep focusing on the subject continuously.**

- The exposure is set at the moment the picture is taken.
- When the AF area selection mode (p.109) is set to Automatic selection AF, focus tracking will continue as long as the Area AF frame covers the subject.

 With AI Servo AF, the beeper will not sound even when focus is achieved. Also, the focus indicator <●> in the viewfinder will not light up.

## AI Focus AF for Switching the AF Operation Automatically

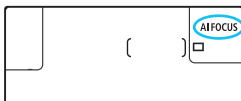

**AI Focus AF switches the AF operation from One-Shot AF to AI Servo AF automatically if a still subject starts moving.**

- After the subject is focused in One-Shot AF, if the subject starts moving, the camera will detect the movement, change the AF operation automatically to AI Servo AF, and start tracking the moving subject.

 When focus is achieved with AI Focus AF with the Servo operation active, the beeper will continue beeping softly. However, the focus indicator <●> in the viewfinder will not light up. Note that focus will not be locked in this case.

## AF Operation Indicator



When you press the shutter button halfway and the camera is focusing with AF, the <AF> icon will appear on the lower right of the viewfinder.

In One-Shot AF mode, the icon also appears if you press the shutter button halfway after focus is achieved.



The AF operation indicator can be displayed outside the viewfinder's field of view (p.151).

## AF Points Lighting Up in Red

By default, the AF points light up in red when focus is achieved in low-light conditions or on a dark subject. In the <P>, <Tv>, <Av>, <M>, or <B> mode, you can set whether to have the AF points light up in red when focus is achieved (p.150).

## Selecting the AF Area and AF Point ★

The camera has 61 AF points for autofocus. You can select the AF area selection mode and AF point(s) suiting the scene or subject.

 Depending on the lens attached to the camera, the number of usable AF points, AF point patterns, Area AF frame shape, etc. vary. For details, see “Lenses and Usable AF Points” on page 115.

### AF Area Selection Mode

You can select one of seven AF area selection modes. For the selection procedure, see page 106.

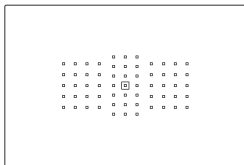

#### **Single-point Spot AF (Manual selection)**

For pinpoint focusing.

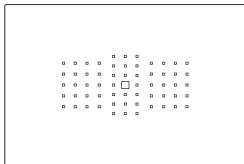

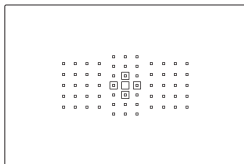

#### **Single-point AF (Manual selection)**

Select one AF point to focus.



#### **AF point expansion (Manual selection )**

The manually-selected AF point  and four adjacent AF points  (above, below, on the left, and on the right) are used to focus.



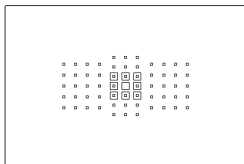

 **AF point expansion**  
(Manual selection,  
surrounding points)

The manually-selected AF point <□> and the surrounding AF points <◻> are used to focus.

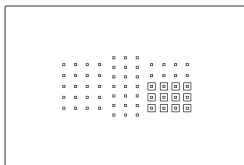

 **Zone AF**  
(Manual selection of zone)

One of nine focusing zones is used to focus.

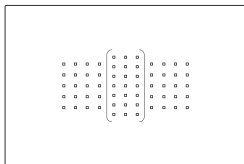

 **Large Zone AF**  
(Manual selection of zone)

One of three focusing zones (left, center, and right) is used to focus.

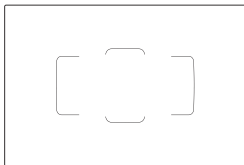

 **Automatic selection AF**

The Area AF frame (entire AF area) is used to focus.

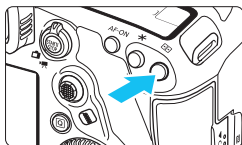

## Selecting the AF Area Selection Mode



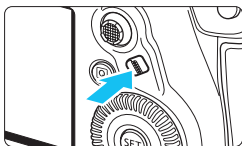



1 Press the  button (ⓘ6).

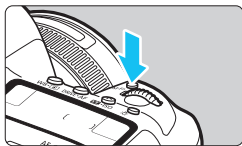

2 Press the  button or <M-Fn> button.

- Look through the viewfinder and press the  (AF area selection) button or <M-Fn> button.
- Each time you press the  button or <M-Fn> button, the AF area selection mode changes.



- With [**AF4: Select AF area selec. mode**], you can limit the selectable AF area selection modes to only those you want to use (p.143).
- If you set [**AF4: AF area selection method**] to [ → **Main Dial**], you can select the AF area selection mode by pressing the  button, then turning the  dial (p.144).

## Selecting the AF Point Manually

You can manually select the AF point or zone.

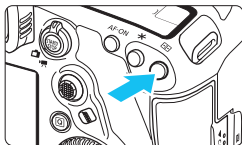

### 1 Press the <☰> button (☰).

- ▶ The AF points will be displayed in the viewfinder.
  - In AF point expansion modes, adjacent AF points will also be displayed.
  - In the Zone AF or Large Zone AF mode, the selected zone will be displayed.

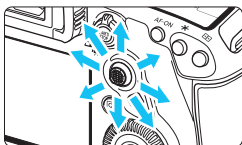

### 2 Select an AF point.

- The AF point selection will change in the direction you tilt <☰>. If you press <☰> straight down, the center AF point (or center zone) will be selected.
- You can also select a horizontal AF point by turning the <☰> dial and select a vertical AF point by turning the <☰> dial.
- In the Zone AF and Large Zone AF modes, turning the <☰> or <☰> dial will change the zone (in a looping sequence for Zone AF).

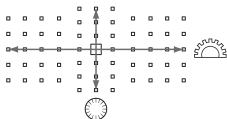

- When [AF4: Initial AF pt, ☰ AI Servo AF] is set to [Initial ☰ AF pt selected] (p.146), you can use this method to manually select the AI Servo AF's initial position.
- When you press the <☰> button, the LCD panel displays the following:
  - Zone AF, Large Zone AF, Automatic selection AF: [☰] AF
  - Single-point spot AF, Single-point AF, AF point expansion: SEL [ ] (Center), SEL AF (Off center)

## AF Point Display Indications

Pressing the <> button lights up the AF points that are cross-type AF points for high-precision autofocusing. The blinking AF points are horizontal-line or vertical-line sensitive. For details, see pages 113-121.

## Registering the AF point

You can register a frequently-used AF point to the camera.

When you use the button set with the [ **3: Custom Controls**] (p.495) menu's detailed settings screens for [**Metering and AF start**], [**Switch to registered AF point**], [**Direct AF point selection**], [**Selected AFpt** ⇄ **Cent/Reg AFpt**], or [**Register/recall shooting func**], you can instantly switch from the current AF point to the registered AF point. For details on registering the AF point, see page 500.

# AF Area Selection Modes ☆

## ▣ Single-point Spot AF (Manual selection)

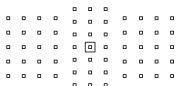

For pinpoint focusing over a narrower area than with Single-point AF. Select one AF point <▣> to focus.

Effective for pinpoint focusing or focusing on overlapping subjects such as an animal in a cage. Since Single-point Spot AF covers a very small area, focusing may be difficult during handheld shooting or for a moving subject.

## □ Single-point AF (Manual selection)

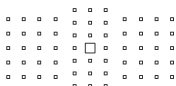

Select one AF point <□> to be used for focusing.



## ▣▣ AF point expansion (Manual selection ▣▣)

The manually-selected AF point <▣> and adjacent AF points <▣> (above, below, on the left, and on the right) are used to focus. Effective when it is difficult to track a moving subject with just one AF point. With AI Servo AF, the initial manually-selected AF point <▣> must focus-track the subject first. However, it is superior to Zone AF in focusing on the target subject.

With One-Shot AF, when focus is achieved with expanded AF points, the expanded AF points <▣> will also be displayed along with the manually-selected AF point <▣>.



### AF point expansion (Manual selection, surrounding points)

The manually-selected AF point <□> and surrounding AF points <○> are used to focus. Focusing is performed over a wider area than with AF point expansion (manual selection ) mode. Effective when it is difficult to track a moving subject with just one AF point. AI Servo AF and One-Shot AF work in the same way as with AF point expansion (manual selection ) mode (p.109).



### Zone AF (Manual selection of zone)

The AF area is divided into nine focusing zones for focusing. All the AF points in the selected zone are used for the automatic AF point selection. It is superior to Single-point AF or AF point expansion in achieving focus, and it is effective for moving subjects. However, since it is inclined to focus on the nearest subject, focusing on a specific target may be more difficult. The AF point(s) achieving focus is displayed as <□>.

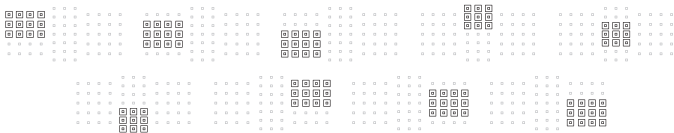

## ( ) Large Zone AF (Manual selection of zone)

The AF area is divided into three focusing zones (left, center, and right) for focusing. Since the focusing area is larger than with Zone AF and all the AF points in the selected zone are used for the automatic AF point selection, it is superior to single-point AF and AF point expansion in tracking the subject, and it is effective for moving subjects.

However, since it is inclined to focus on the nearest subject, focusing on a specific target may be more difficult.

The AF point(s) achieving focus is displayed as <□>.



## ( ) Automatic selection AF

The Area AF frame (entire AF area) is used to focus. The AF point(s) achieving focus is displayed as <□>.

With One-Shot AF, pressing the shutter button halfway will display the AF point(s) <□> that achieved focus. If multiple AF points are displayed, it means they all have achieved focus. This mode tends to focus on the nearest subject.

With AI Servo AF, you can set the AI Servo AF's initial position with [**AF4: Initial AF pt**, ( ) **AI Servo AF**] (p.146). As long as the Area AF frame can track the subject during shooting, focusing will continue.

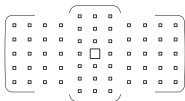

- When AI Servo AF mode is set for Zone AF, Large Zone AF, or Automatic selection AF, the active AF point <□> will keep switching to track the subject. However, under certain shooting conditions (such as when the subject is small), it may not be able to track the subject.
- With Single-point Spot AF, focusing with an EOS-dedicated, external Speedlite's AF-assist beam may be difficult.
- If a peripheral AF point or a wide-angle or telephoto lens is used, achieving focus may be difficult with an EOS-dedicated, external Speedlite's AF-assist beam. In such a case, use the center AF point or an AF point close to the center.
- In low temperatures, the AF point display may be difficult to see due to the characteristics of AF point display (using liquid crystal).

- With [**AF4: Orientation linked AF point**], you can set the AF area selection mode + AF point or only the AF point separately for the horizontal and vertical orientations (p.144).
- With [**AF4: Selectable AF point**], you can change the number of manually selectable AF points (p.142).



## AF Sensor

The camera's AF sensor has 61 AF points. The illustration below shows the AF sensor pattern corresponding to each AF point. When using lenses with a maximum aperture of  $f/2.8$  or faster, high-precision AF is possible at the viewfinder center.

Depending on the lens attached to the camera, the number of usable AF points, AF point patterns, Area AF frame shape, etc. vary. For details, see "Lenses and Usable AF Points" on page 115.

### Diagram

Cross-type focusing:

$f/4$  horizontal +  $f/5.6$  or  $f/8$  vertical

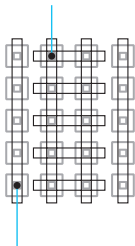

$f/5.6$  or  $f/8$  vertical focusing

Cross-type focusing:

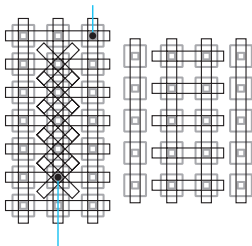

$f/5.6$  or  $f/8$  vertical +  $f/5.6$  or  $f/8$  horizontal



Dual cross-type focusing:

$f/2.8$  right diagonal +  $f/2.8$  left diagonal

$f/5.6$  or  $f/8$  vertical +  $f/5.6$  or  $f/8$  horizontal

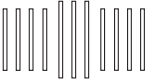
	<p>These focusing sensors are geared to obtain higher precision focusing for lenses with a maximum aperture of <math>f/2.8</math> or faster. A diagonal cross pattern makes it easier to focus subjects that may be difficult to focus. They cover the five AF points vertically aligned at the center.</p>
	<p>These focusing sensors are geared to obtain high-precision focusing for lenses with a maximum aperture of <math>f/4</math> or faster. Since they have a horizontal pattern, they can detect vertical lines.</p>
	<p>These focusing sensors are geared for lenses with a maximum aperture of <math>f/5.6</math> or faster (greater than <math>f/5.6</math> but not exceeding <math>f/8</math> with an extender attached). Since they have a horizontal pattern, they can detect vertical lines. They cover the three columns of AF points at the viewfinder center.</p>
	<p>These focusing sensors are geared for lenses with a maximum aperture of <math>f/5.6</math> or faster (greater than <math>f/5.6</math> but not exceeding <math>f/8</math> with an extender attached). Since they have a vertical pattern, they can detect horizontal lines. They cover all 61 AF points.</p>

# Lenses and Usable AF Points



- Although the camera has 61 AF points, **the number of usable AF points, focusing patterns, Area AF frame shape, etc. vary depending on the lens. The lenses are thereby classified into eleven groups from A to K.**
- **When using a lens in groups G to K, fewer AF points will be usable.**
- **Lens groups are listed on pages 122-126. Check which group your lens belongs to.**



- When you press the <[AF-ON]> button, the AF points indicated by the □ mark will blink. (The ■/▒/□ AF points will stay lit.) Regarding lighting up or blinking of the AF points, see page 108.
- Regarding new lenses released after the EOS 5D Mark IV (in the second half of 2016), check the Canon Web site to see which group they belong to.
- Some lenses may not be available in certain countries or regions.

## Group A

Autofocusing with 61 points is possible. All the AF area selection modes are selectable.



- : Dual cross-type AF point. Subject tracking is superior and the focusing precision is higher than with other AF points.
- ▒: Cross-type AF point. Subject tracking is superior and high-precision focusing is achieved.
- : AF points sensitive to horizontal lines.

## Group B

Autofocusing with 61 points is possible. All the AF area selection modes are selectable.

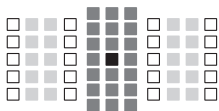

- : Dual cross-type AF point. Subject tracking is superior and the focusing precision is higher than with other AF points.
- : Cross-type AF point. Subject tracking is superior and high-precision focusing is achieved.
- : AF points sensitive to horizontal lines.

## Group C

Autofocusing with 61 points is possible. All the AF area selection modes are selectable.

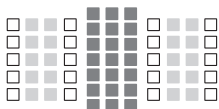

- : Cross-type AF point. Subject tracking is superior and high-precision focusing is achieved.
- : AF points sensitive to horizontal lines.

## Group D

Autofocusing with 61 points is possible. All the AF area selection modes are selectable.

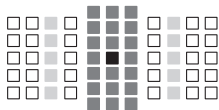

- : Dual cross-type AF point. Subject tracking is superior and the focusing precision is higher than with other AF points.
- : Cross-type AF point. Subject tracking is superior and high-precision focusing is achieved.
- : AF points sensitive to horizontal lines.

## Group E

Autofocusing with 61 points is possible. All the AF area selection modes are selectable.

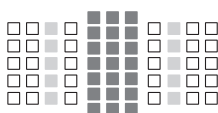

- : Cross-type AF point. Subject tracking is superior and high-precision focusing is achieved.
- : AF points sensitive to horizontal lines.

## Group F

Autofocusing with 61 points is possible. All the AF area selection modes are selectable.

If an extender is attached (extender compatible lenses only) and the maximum aperture is  $f/8$  (greater than  $f/5.6$  but not exceeding  $f/8$ ), AF will be possible.

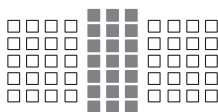

- : Cross-type AF point. Subject tracking is superior and high-precision focusing is achieved.
- : AF points sensitive to horizontal lines.



- If the maximum aperture is slower than  $f/5.6$  (greater than  $f/5.6$  but not exceeding  $f/8$ ), focus may not be achieved with AF when shooting low-contrast or low-light subjects.
- If the maximum aperture is slower than  $f/8$  (exceeding  $f/8$ ), AF is not possible during viewfinder shooting.

## Group G

Autofocusing with the 47 points shown in the diagram is possible. (Not possible with all 61 AF points.) All the AF area selection modes are selectable. During automatic AF point selection, the outer frame marking the AF area (Area AF frame) will be different from 61-point Automatic selection AF.

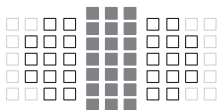

- : Cross-type AF point. Subject tracking is superior and high-precision focusing is achieved.
- : AF points sensitive to horizontal lines.
- : Disabled AF points (not displayed).

## Group H

Autofocusing with the 33 points shown in the diagram is possible. (Not possible with all 61 AF points.) All the AF area selection modes are selectable. During automatic AF point selection, the outer frame marking the AF area (Area AF frame) will be different from 61-point Automatic selection AF.

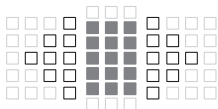

- : Cross-type AF point. Subject tracking is superior and high-precision focusing is achieved.
- : AF points sensitive to horizontal lines.
- : Disabled AF points (not displayed).

## Group I

Autofocusing with the 13 points shown in the diagram is possible. Only the following AF area selection modes are selectable: Single-point Spot AF, Single-point AF, AF point expansion (manual selection<sup>①</sup>), Zone AF (Manual selection of zone), and 13-point automatic selection AF.

If an extender is attached (extender compatible lenses only) and the maximum aperture is  $f/8$  (greater than  $f/5.6$  but not exceeding  $f/8$ ), AF will be possible.



- : Cross-type AF point. Subject tracking is superior and high-precision focusing is achieved.
- : AF points sensitive to horizontal lines (AF points in line extending left and right through center AF point) or vertical lines (top and bottom AF points adjacent to the center AF point).
- : Disabled AF points (not displayed).



- Even when AF point expansion (manual selection<sup>①</sup>) is set, AF point expansion will be applied to the 13 AF points. If the manually selected AF point does not have all four AF points on the top, bottom, left, or right, it will expand only to those active AF points that are adjacent to it.
- If the maximum aperture is slower than  $f/5.6$  (greater than  $f/5.6$  but not exceeding  $f/8$ ), focus may not be achieved with AF when shooting low-contrast or low-light subjects.
- If the maximum aperture is slower than  $f/8$  (exceeding  $f/8$ ), AF is not possible during viewfinder shooting.

## Group J

Autofocusing with the 9 points shown in the diagram is possible. Only the following AF area selection modes are selectable: Single-point Spot AF, Single-point AF, AF point expansion (manual selection $\square$ ), and 9-point automatic selection AF.

If an extender is attached (extender compatible lenses only) and the maximum aperture is f/8 (greater than f/5.6 but not exceeding f/8), AF will be possible.



- : Cross-type AF point. Subject tracking is superior and high-precision focusing is achieved.
- : AF points sensitive to horizontal lines (AF points in line extending left and right through center AF point) or vertical lines (top and bottom AF points adjacent to the center AF point).
- : Disabled AF points (not displayed).

- Even when AF point expansion (manual selection $\square$ ) is set, AF point expansion will be applied to the 9 AF points. If the manually selected AF point does not have all four AF points on the top, bottom, left, or right, it will expand only to those active AF points that are adjacent to it.
- If the maximum aperture is slower than f/5.6 (greater than f/5.6 but not exceeding f/8), focus may not be achieved with AF when shooting low-contrast or low-light subjects.
- If the maximum aperture is slower than f/8 (exceeding f/8), AF is not possible during viewfinder shooting.



## Group K

AF is possible with the center AF point and the adjacent AF points above, below, on the left, and on the right. Only the following AF area selection modes are selectable: Single-point Spot AF, Single-point AF, and AF point expansion (manual selection<sup>□</sup><sub>□</sub><sup>□</sup><sub>□</sub>).



- : Cross-type AF point. Subject tracking is superior and high-precision focusing is achieved.
- : AF points sensitive to horizontal lines (left and right AF points adjacent to the center AF point) or vertical lines (top and bottom AF points adjacent to the center AF point). Not manually selectable. It works only when AF point expansion (manual selection<sup>□</sup><sub>□</sub><sup>□</sup><sub>□</sub>) is selected.
- : Disabled AF points (not displayed).

## Lens Group Designations

EF14mm f/2.8L USM	B	EF180mm f/3.5L Macro USM	H
EF14mm f/2.8L II USM	B	EF180mm f/3.5L Macro USM + Extender EF1.4x I/II/III	H
EF15mm f/2.8 Fisheye	B	EF200mm f/1.8L USM	A
EF20mm f/2.8 USM	B	EF200mm f/1.8L USM + Extender EF1.4x I/II/III	A*
EF24mm f/1.4L USM	A	EF200mm f/1.8L USM + Extender EF2x I/II/III	C*
EF24mm f/1.4L II USM	A	EF200mm f/2L IS USM	A
EF24mm f/2.8	B	EF200mm f/2L IS USM + Extender EF1.4x I/II/III	A
EF24mm f/2.8 IS USM	B	EF200mm f/2L IS USM + Extender EF2x I/II/III	C
EF28mm f/1.8 USM	A	EF200mm f/2.8L USM	A
EF28mm f/2.8	D	EF200mm f/2.8L USM + Extender EF1.4x I/II/III	C
EF28mm f/2.8 IS USM	B	EF200mm f/2.8L USM + Extender EF2x I/II/III	F
EF35mm f/1.4L USM	A	EF200mm f/2.8L II USM	A
EF35mm f/1.4L II USM	A	EF200mm f/2.8L II USM + Extender EF1.4x I/II/III	C
EF35mm f/2	A	EF200mm f/2.8L II USM + Extender EF2x I/II/III	F
EF35mm f/2 IS USM	A	EF300mm f/2.8L USM	A
EF40mm f/2.8 STM	D	EF300mm f/2.8L USM + Extender EF1.4x I/II/III	C*
EF50mm f/1.0L USM	A	EF300mm f/2.8L USM + Extender EF2x I/II/III	F*
EF50mm f/1.2L USM	A	EF300mm f/2.8L IS USM	A
EF50mm f/1.4 USM	A	EF300mm f/2.8L IS USM + Extender EF1.4x I/II/III	C
EF50mm f/1.8	A	EF300mm f/2.8L IS USM + Extender EF2x I/II/III	F
EF50mm f/1.8 II	A	EF300mm f/2.8L IS II USM	A
EF50mm f/1.8 STM	A	EF300mm f/2.8L IS II USM + Extender EF1.4x I/II/III	C
EF50mm f/2.5 Compact Macro	C	EF300mm f/2.8L IS II USM + Extender EF2x I/II/III	F
EF50mm f/2.5 Compact Macro + LIFE SIZE Converter	F	EF300mm f/4L USM	C
EF85mm f/1.2L USM	A	EF300mm f/4L USM + Extender EF1.4x I/II/III	F
EF85mm f/1.2L II USM	A	EF300mm f/4L USM + Extender EF2x I/II/III	F
EF85mm f/1.4L IS USM	A	EF300mm f/4L USM + Extender EF2x I/II/III	J (f/8)
EF85mm f/1.8 USM	A		
EF100mm f/2 USM	A		
EF100mm f/2.8 Macro	C		
EF100mm f/2.8 Macro USM	F		
EF100mm f/2.8L Macro IS USM	C		
EF135mm f/2L USM	A		
EF135mm f/2L USM + Extender EF1.4x I/II/III	A		
EF135mm f/2L USM + Extender EF2x I/II/III	C		
EF135mm f/2.8 (Sofffocus)	A		

EF300mm f/4L USM + Extender EF2x III	I (f/8)	EF400mm f/5.6L USM + Extender EF1.4x III	F (f/8)
EF300mm f/4L IS USM	C	EF500mm f/4L IS USM	C
EF300mm f/4L IS USM + Extender EF1.4x I/II/III	F	EF500mm f/4L IS USM + Extender EF1.4x I/II/III	F
EF300mm f/4L IS USM + Extender EF2x I/II	J (f/8)	EF500mm f/4L IS USM + Extender EF2x I/II	J (f/8)
EF300mm f/4L IS USM + Extender EF2x III	I (f/8)	EF500mm f/4L IS USM + Extender EF2x III	F (f/8)
EF400mm f/2.8L USM	A	EF500mm f/4L IS II USM	C
EF400mm f/2.8L USM + Extender EF1.4x I/II/III	C*	EF500mm f/4L IS II USM + Extender EF1.4x I/II/III	F
EF400mm f/2.8L USM + Extender EF2x I/II/III	F*	EF500mm f/4L IS II USM + Extender EF2x I/II	J (f/8)
EF400mm f/2.8L II USM	A	EF500mm f/4L IS II USM + Extender EF2x III	F (f/8)
EF400mm f/2.8L II USM + Extender EF1.4x I/II/III	C*	EF500mm f/4.5L USM	F
EF400mm f/2.8L II USM + Extender EF2x I/II/III	F*	EF500mm f/4.5L USM + Extender EF1.4x I/II	J (f/8)
EF400mm f/2.8L IS USM	A	EF500mm f/4.5L USM + Extender EF1.4x III	F (f/8)*
EF400mm f/2.8L IS USM + Extender EF1.4x I/II/III	C	EF600mm f/4L USM	C
EF400mm f/2.8L IS USM + Extender EF2x I/II/III	F	EF600mm f/4L USM + Extender EF1.4x I/II/III	F*
EF400mm f/2.8L IS II USM	A	EF600mm f/4L USM + Extender EF2x I/II	J (f/8)
EF400mm f/2.8L IS II USM + Extender EF1.4x I/II/III	C	EF600mm f/4L USM + Extender EF2x III	F (f/8)*
EF400mm f/2.8L IS II USM + Extender EF2x I/II/III	F	EF600mm f/4L IS USM	C
EF400mm f/4 DO IS USM	C	EF600mm f/4L IS USM + Extender EF1.4x I/II/III	F
EF400mm f/4 DO IS USM + Extender EF1.4x I/II/III	F	EF600mm f/4L IS USM + Extender EF2x I/II	J (f/8)
EF400mm f/4 DO IS USM + Extender EF2x I/II	J (f/8)	EF600mm f/4L IS USM + Extender EF2x III	F (f/8)
EF400mm f/4 DO IS USM + Extender EF2x III	F (f/8)	EF600mm f/4L IS II USM	C
EF400mm f/4 DO IS II USM	C	EF600mm f/4L IS II USM + Extender EF1.4x I/II/III	F
EF400mm f/4 DO IS II USM + Extender EF1.4x I/II/III	F	EF600mm f/4L IS II USM + Extender EF2x I/II	J (f/8)
EF400mm f/4 DO IS II USM + Extender EF2x I/II	J (f/8)	EF600mm f/4L IS II USM + Extender EF2x III	F (f/8)
EF400mm f/4 DO IS II USM + Extender EF2x III	F (f/8)	EF800mm f/5.6L IS USM	G
EF400mm f/5.6L USM	F	EF800mm f/5.6L IS USM + Extender EF1.4x I/II/III	J (f/8)
EF400mm f/5.6L USM + Extender EF1.4x I/II	J (f/8)	EF1200mm f/5.6L USM	H

## Lenses and Usable AF Points

EF1200mm f/5.6L USM + Extender EF1.4x I/II/III	J (f/8)*	EF28-200mm f/3.5-5.6 USM	F
EF8-15mm f/4L Fisheye USM	C	EF28-300mm f/3.5-5.6L IS USM	F
EF11-24mm f/4L USM	E	EF35-70mm f/3.5-4.5	G
EF16-35mm f/2.8L USM	A	EF35-70mm f/3.5-4.5A	G
EF16-35mm f/2.8L II USM	A	EF35-80mm f/4-5.6	G
EF16-35mm f/2.8L III USM	A	EF35-80mm f/4-5.6 PZ	G
EF16-35mm f/4L IS USM	C	EF35-80mm f/4-5.6 USM	G
EF17-35mm f/2.8L USM	A	EF35-80mm f/4-5.6 II	G
EF17-40mm f/4L USM	C	EF35-80mm f/4-5.6 III	G
EF20-35mm f/2.8L	A	EF35-105mm f/3.5-4.5	F
EF20-35mm f/3.5-4.5 USM	F	EF35-105mm f/4-5-5.6	K
EF22-55mm f/4-5.6 USM	G	EF35-105mm f/4.5-5.6 USM	K
EF24-70mm f/2.8L USM	B	EF35-135mm f/3.5-4.5	F
EF24-70mm f/2.8L II USM	A	EF35-135mm f/4-5.6 USM	F
EF24-70mm f/4L IS USM	C	EF35-350mm f/3.5-5.6L USM	G
EF24-85mm f/3.5-4.5 USM	F	EF38-76mm f/4.5-5.6	F
EF24-105mm f/3.5-5.6 IS STM	F	EF50-200mm f/3.5-4.5	F
EF24-105mm f/4L IS USM	C	EF50-200mm f/3.5-4.5L	F
EF24-105mm f/4L IS II USM	C	EF55-200mm f/4.5-5.6 USM	F
EF28-70mm f/2.8L USM	A	EF55-200mm f/4.5-5.6 II USM	F
EF28-70mm f/3.5-4.5	G	EF70-200mm f/2.8L USM	A
EF28-70mm f/3.5-4.5 II	G	EF70-200mm f/2.8L USM + Extender EF1.4x I/II/III	C**
EF28-80mm f/2.8-4L USM	C	EF70-200mm f/2.8L USM + Extender EF2x I/II/III	F**
EF28-80mm f/3.5-5.6	G	EF70-200mm f/2.8L IS USM	A
EF28-80mm f/3.5-5.6 USM	G	EF70-200mm f/2.8L IS USM + Extender EF1.4x I/II/III	C
EF28-80mm f/3.5-5.6 II	G	EF70-200mm f/2.8L IS USM + Extender EF2x I/II/III	F
EF28-80mm f/3.5-5.6 III USM	G	EF70-200mm f/2.8L IS II USM	A
EF28-80mm f/3.5-5.6 IV USM	G	EF70-200mm f/2.8L IS II USM + Extender EF1.4x I/II/III	C
EF28-80mm f/3.5-5.6 V USM	G	EF70-200mm f/2.8L IS II USM + Extender EF2x I/II/III	F
EF28-90mm f/4-5.6	F	EF70-200mm f/4L USM	C
EF28-90mm f/4-5.6 USM	F	EF70-200mm f/4L USM + Extender EF1.4x I/II/III	F
EF28-90mm f/4-5.6 II	F	EF70-200mm f/4L USM + Extender EF2x I/II	J (f/8)
EF28-90mm f/4-5.6 II USM	F	EF70-200mm f/4L USM + Extender EF2x III	I (f/8)
EF28-90mm f/4-5.6 III	F	EF70-200mm f/4L IS USM	C
EF28-105mm f/3.5-4.5 USM	F		
EF28-105mm f/3.5-4.5 II USM	F		
EF28-105mm f/4-5.6	G		
EF28-105mm f/4-5.6 USM	G		
EF28-135mm f/3.5-5.6 IS USM	F		
EF28-200mm f/3.5-5.6	F		

EF70-200mm f/4L IS USM + Extender EF1.4x I/II/III	F	EF100-400mm f/4.5-5.6L IS USM + Extender EF1.4x I/II	J (f/8)
EF70-200mm f/4L IS USM + Extender EF2x I/II	J (f/8)	EF100-400mm f/4.5-5.6L IS USM + Extender EF1.4x III	F (f/8)
EF70-200mm f/4L IS USM + Extender EF2x III	I (f/8)	EF100-400mm f/4.5-5.6L IS II USM	F
EF70-210mm f/3.5-4.5 USM	F	EF100-400mm f/4.5-5.6L IS II USM + Extender EF1.4x I/II	J (f/8)
EF70-210mm f/4	C	EF100-400mm f/4.5-5.6L IS II USM + Extender EF1.4x III	F (f/8)
EF70-300mm f/4-5.6 IS USM	F	EF200-400mm f/4L IS USM Extender 1.4x	E
EF70-300mm f/4-5.6 IS II USM	F	EF200-400mm f/4L IS USM Extender 1.4x: Built-in Ext.1.4x used	F
EF70-300mm f/4-5.6L IS USM	F	EF200-400mm f/4L IS USM Extender 1.4x + Extender EF1.4x I/II/III	F
EF70-300mm f/4.5-5.6 DO IS USM	F	EF200-400mm f/4L IS USM Extender 1.4x: Built-in Ext.1.4x used + Extender EF1.4x I/II	J (f/8)
EF75-300mm f/4-5.6	F	EF200-400mm f/4L IS USM Extender 1.4x: Built-in Ext.1.4x used + Extender EF1.4x III	F (f/8)
EF75-300mm f/4-5.6 USM	F	EF200-400mm f/4L IS USM Extender 1.4x + Extender EF2x I/II	J (f/8)
EF75-300mm f/4-5.6 II	F	EF200-400mm f/4L IS USM Extender 1.4x + Extender EF2x III	F (f/8)
EF75-300mm f/4-5.6 II USM	F	TS-E17mm f/4L	C
EF75-300mm f/4-5.6 III	F	TS-E24mm f/3.5L	C
EF75-300mm f/4-5.6 III USM	F	TS-E24mm f/3.5L II	C
EF75-300mm f/4-5.6 IS USM	F	TS-E45mm f/2.8	A
EF80-200mm f/2.8L	A	TS-E50mm f/2.8L Macro	C
EF80-200mm f/4.5-5.6	F	TS-E90mm f/2.8	A
EF80-200mm f/4.5-5.6 USM	G	TS-E90mm f/2.8L Macro	C
EF80-200mm f/4.5-5.6 II	G	TS-E135mm f/4L Macro	C
EF90-300mm f/4.5-5.6	F		
EF90-300mm f/4.5-5.6 USM	F		
EF100-200mm f/4.5A	F		
EF100-300mm f/4.5-5.6 USM	F		
EF100-300mm f/5.6	F		
EF100-300mm f/5.6L	F		
EF100-400mm f/4.5-5.6L IS USM	F		

-  ● If Extender EF2x (I/II/III) is attached to the EF180mm f/3.5L Macro USM lens, AF is not possible.
- When using a lens and Extender EF1.4x III/EF2x III in a combination marked with an asterisk (\*) or a lens and extender in a combination marked with two asterisks (\*\*), precise focus may not be achieved with AF. In such a case, refer to the Instruction Manual of the lens or extender used.

 If you use a TS-E lens, manual focusing will be required. The lens group designation of TS-E lenses applies only when you do not use the tilt or shift function.

## MENU Selecting AI Servo AF Characteristics ☆

You can easily fine-tune AI Servo AF to suit a particular subject or shooting scene just by selecting an option from case 1 to case 6. This feature is called the “AF Configuration Tool”.

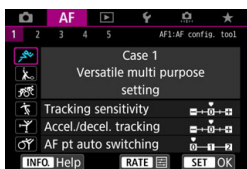

1 Select the [AF1] tab.

2 Select a case.

- Turn the < > dial to select a case icon, then press < >.
- ▶ The selected case will be set. The selected case is indicated in blue.

### Case 1 to 6

As explained on pages 132 to 134, case 1 to 6 are six setting combinations of “Tracking sensitivity”, “Acceleration/deceleration tracking”, and “AF point auto switching”. Refer to the table below to select the case applicable to the subject or shooting scene.

Case	Icon	Description	Applicable Subjects	Page
Case 1		Versatile multi purpose setting	For any moving subject.	128
Case 2		Continue to track subjects, ignoring possible obstacles	Tennis players, butterfly swimmers, freestyle skiers, etc.	128
Case 3		Instantly focus on subjects suddenly entering AF points	Starting line of a bicycle race, alpine downhill skiers, etc.	129
Case 4		For subjects that accelerate or decelerate quickly	Soccer, motor sports, basketball, etc.	129
Case 5		For erratic subjects moving quickly in any direction	Figure skaters, etc.	130
Case 6		For subjects that change speed and move erratically	Rhythm gymnastics, etc.	131

## Case 1: Versatile multi purpose setting



Standard setting suited for any moving subject. Works with various subjects and scenes.

Select [Case 2] to [Case 6] for the following: When an obstacle cuts across the AF points or the subject tends to stray from the AF points, when you want to focus on a subject appearing suddenly, when the speed of a moving subject changes suddenly, or when the subject dramatically moves horizontally or vertically.

### Default settings

- Tracking sensitivity: 0
- Accel./decel. tracking: 0
- AF pt auto switching: 0

## Case 2: Continue to track subjects, ignoring possible obstacles

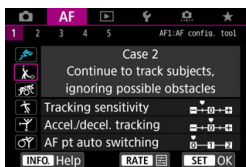

The camera will try to continue focusing on the subject even if an obstacle cuts across the AF points or if the subject strays from the AF points. Effective when there may be an obstacle blocking the subject or when you do not want to focus on the background.

### Default settings

- Tracking sensitivity: Locked on: -1
- Accel./decel. tracking: 0
- AF pt auto switching: 0

If an obstacle gets in the way or if the subject moves away from the AF points for a prolonged period and the default setting is unable to track the target subject, setting [Tracking sensitivity] to [-2] may give better results (p.132).



### Case 3: Instantly focus on subjects suddenly entering AF points

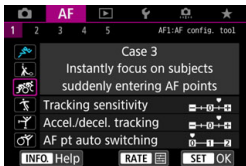

Once an AF point starts tracking the subject, this setting enables the camera to consecutively focus on subjects at different distances. If a new subject appears in front of the target subject, the camera will start focusing on the new subject. Also effective when you want to always focus on the closest subject.

#### Default settings

- Tracking sensitivity: Responsive: +1
- Accel./decel. tracking: +1
- AF pt auto switching: 0



If you want to quickly focus on a subject appearing suddenly, setting [**Tracking sensitivity**] to [+2] may give better results (p.132).

### Case 4: For subjects that accelerate or decelerate quickly

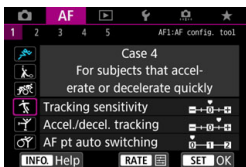

Geared for tracking moving subjects whose speed can change dramatically and suddenly.

Effective for subjects having sudden movements, sudden acceleration, sudden deceleration, or sudden stops.

#### Default settings

- Tracking sensitivity: 0
- Accel./decel. tracking: +1
- AF pt auto switching: 0



If the subject is in motion, and prone to sudden, dramatic changes in speed, setting [**Accel./decel. tracking**] to [+2] may give better results (p.133).

## Case 5: For erratic subjects moving quickly in any direction

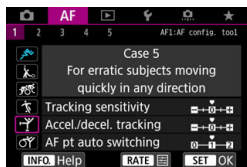

### Default settings

- Tracking sensitivity: 0
- Accel./decel. tracking: 0
- AF pt auto switching: +1

Even if the target subject moves dramatically up, down, left, or right, the AF point will switch automatically to focus-track the subject. Effective for shooting subjects that move dramatically up, down, left, or right.

It is recommended to use this setting with the following modes; AF point expansion (manual selection  $\square \square \square$ ), AF point expansion (manual selection, surrounding points), Zone AF, Large Zone AF, and Automatic selection AF. With Single-point Spot AF or Single-point AF mode, the tracking action will be the same as with Case 1.

 If the subject moves even more dramatically up, down, left, or right, setting [AF pt auto switching] to [+2] may give better results (p.134).

## Case 6: For subjects that change speed and move erratically

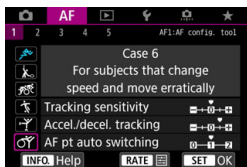

### Default settings

- Tracking sensitivity: 0
- Accel./decel. tracking: +1
- AF pt auto switching: +1

Geared for tracking moving subjects whose speed can change dramatically and suddenly. Also, if the target subject moves dramatically up, down, left or right and it is difficult to focus, the AF point switches automatically to track the subject.

It is recommended to use this setting with the following modes; AF point expansion (manual selection  $\square \square \square$ ), AF point expansion (manual selection  $\square \square \square$ ), AF point expansion (manual selection  $\square \square \square$ ), Zone AF, Large Zone AF, and Automatic selection AF. With Single-point Spot AF or Single-point AF mode, the tracking action will be the same as with Case 4.



- If the subject is in motion, and prone to sudden, dramatic changes in speed, setting **[Accel./decel. tracking]** to **[+2]** may give better results (p.133).
- If the subject moves even more dramatically up, down, left, or right, setting **[AF pt auto switching]** to **[+2]** may give better results (p.134).

## Parameters

### ● Tracking sensitivity

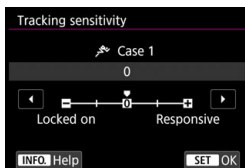

Sets the subject-tracking sensitivity during AI Servo AF when an obstacle cuts across the AF points or when the subject strays from the AF point.

**0**  
Default setting. Suitable for moving subjects in general.

#### **Locked on: -2 / Locked on: -1**

The camera will try to continue focusing on the subject even if an obstacle cuts across the AF points or if the subject strays from the AF points. The -2 setting makes the camera keep tracking the target subject longer than the -1 setting.

However, if the camera focuses on a wrong subject, it may take slightly longer to switch and focus on the target subject.

#### **Responsive: +2 / Responsive: +1**

The camera can focus consecutively on subjects at different distances that are covered by the AF points. Also effective when you want to always focus on the closest subject. The +2 setting is more responsive than the +1 setting when focusing on the next subject. However, the camera will be more prone to focus on an unintended subject.

 [Tracking sensitivity] is the feature named [AI Servo tracking sensitivity] in the EOS-1D Mark III/IV, EOS-1Ds Mark III, and EOS 7D.

## ● Acceleration/deceleration tracking

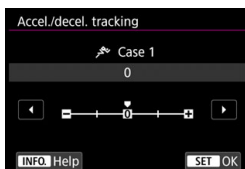

This sets the tracking sensitivity for moving subjects whose speed can momentarily change dramatically by starting or stopping suddenly, etc.

### 0

Suited for subjects that move at a steady speed (minor changes in moving speed).

### -2 / -1

Suited for subjects that move at a steady speed (minor changes in moving speed). It is effective when 0 is set but focus is unstable due to the subject's slight movement or an obstacle in front of the subject.

### +2 / +1

Effective for subjects having sudden movements, sudden acceleration/deceleration, or sudden stops. Even if the moving subject's speed suddenly changes dramatically, the camera continues to focus on the target subject. For example, for an approaching subject, the camera becomes less prone to focus behind it to avoid subject blur. For a subject stopping suddenly, the camera becomes less prone to focus in front of it. Setting +2 can track dramatic changes in the moving subject's speed better than with +1.

However, since the camera will be sensitive to even slight movements of the subject, focusing may become unstable for short periods.

## ● AF point auto switching

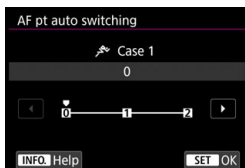

This sets the switching sensitivity of the AF points as they track the subject moving dramatically up, down, left, or right.

This setting takes effect when the AF area selection mode is set to AF point expansion (manual selection  $\square$ ), AF point expansion (manual selection, surrounding points), Zone AF, Large Zone AF, or Automatic selection AF.

### 0

Standard setting for gradual AF point switching.

### +2 / +1

Even if the target subject moves dramatically up, down, left, or right and moves away from the AF point, the camera switches its focus to neighboring AF points to continue focusing on the subject. The camera switches to the AF point deemed most likely to focus on the subject based on the subject's continual movement, contrast, etc. Setting +2 makes the camera more prone to switch the AF point than with +1.

However, with a wide-angle lens having a wide depth of field or if the subject is too small in the frame, the camera may focus with an unintended AF point.

## Changing Cases' Parameter Settings

You can manually adjust each case's three parameters: 1. Tracking sensitivity, 2. Acceleration/deceleration tracking, and 3. AF point auto switching.

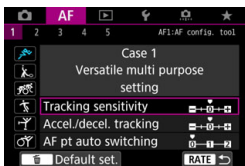

### 1 Select a case.

- Turn the <DIAL> dial to select the icon of the case you want to adjust.

### 2 Press the <RATE> button.

- The selected parameter will be highlighted with a purple frame.

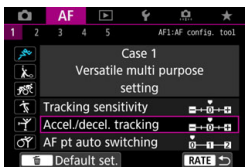

### 3 Select the parameter to adjust.

- Select the parameter to adjust, then press <SET>.



### 4 Make the adjustment.

- Adjust the setting, then press <SET>.
- ▶ The adjustment is saved.
- The default setting is indicated by the light gray [ ] mark.
- To return to the screen in step 1, press the <RATE> button.



- In step 2, if you press the <RATE> button, then press the <REVERT> button, you can revert the 1, 2, and 3 parameter settings above for each case to their defaults.
- You can also register the 1, 2, and 3 parameter settings to My Menu (p.515). Doing so will change the selected case's settings.
- When shooting with a case whose parameters you adjusted, select the adjusted case, then take the picture.

## MENU Customizing AF Functions ☆

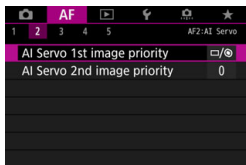

With the [ **AF2** ] to [ **AF5** ] menu tabs, you can set the AF functions to suit your shooting style or subject.

### AF2: AI Servo

#### AI Servo 1st image priority

AF2

You can set the AF operation characteristics and shutter-release timing for the first shot with AI Servo AF.

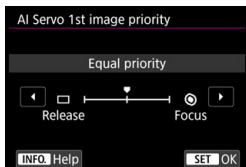

#### □/☉: Equal priority

Equal priority is given to focusing and shutter release.

#### □: Release priority

Pressing the shutter button takes the picture immediately even if focus has not been achieved. Useful when you want to give priority to capturing the decisive moment rather than achieving focus.

#### ☉: Focus priority

Pressing the shutter button does not take the picture until focus is achieved. Useful when you want to achieve focus before capturing the image.



## AI Servo 2nd image priority

AF2

With AI Servo AF for continuous shooting, you can preset the AF operation characteristics and shutter-release timing for the subsequent shots after the first shot in continuous shooting.

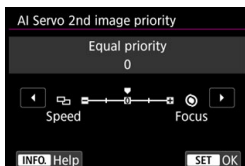
**0: Equal priority**

Equal priority is given to focusing and continuous shooting speed. In low light or with low-contrast subjects, continuous shooting speed may slow down.

**-2/-1: Shooting speed priority**

Priority is given to the continuous shooting speed instead of achieving focus. With -2, decrease of continuous shooting speed can be better prevented than with -1.

**+2/+1: Focus priority**

Priority is given to achieving focus instead of the continuous shooting speed. The picture will not be taken until focus is achieved. Although focus can be achieved easier in low-light conditions with +2 than with +1, continuous shooting speed may decrease.



Under shooting conditions that activate flicker reduction (p.215), even if **[Shooting speed priority]: [-1] or [-2]** is set, the continuous shooting speed may become slower or the shooting interval may become irregular.



If focus cannot be achieved in low-light conditions when **[0: Equal priority]** is set, setting **[Focus priority]: [+1] or [+2]** may give better results.

## AF3: One Shot

## Lens electronic MF

AF3

With the following USM and STM lenses equipped with an electronic manual focusing function, you can set whether to use electronic manual focusing.

EF50mm f/1.0L USM	EF300mm f/2.8L USM	EF600mm f/4L USM
EF85mm f/1.2L USM	EF400mm f/2.8L USM	EF1200mm f/5.6L USM
EF85mm f/1.2L II USM	EF400mm f/2.8L II USM	EF28-80mm f/2.8-4L USM
EF200mm f/1.8L USM	EF500mm f/4.5L USM	EF70-300mm f/4-5.6 IS II USM
EF40mm f/2.8 STM	EF50mm f/1.8 STM	EF24-105mm f/3.5-5.6 IS STM

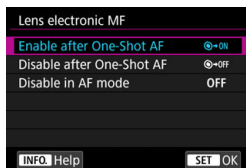

**☉→ON : Enable after One-Shot AF**

After the AF operation, if you keep pressing the shutter button halfway, you can adjust the focus manually.

**☉→OFF : Disable after One-Shot AF**

After the AF operation, manual focusing adjustment is disabled.

**OFF: Disable in AF mode**

When the lens's focus mode switch is set to <AF>, manual focusing is disabled.

**AF-assist beam firing**

AF3

Enables or disables the EOS-dedicated external Speedlite's AF-assist beam.

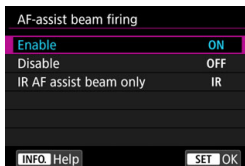
**ON: Enable**

The external Speedlite emits the AF-assist beam when necessary.

**OFF: Disable**

The external Speedlite will not emit the AF-assist beam. Useful when the AF-assist beam may disturb others.

**IR: IR AF assist beam only**

When an external Speedlite is attached, only the infrared AF-assist beam will be emitted. Useful when you do not want to fire a series of small flashes as the AF-assist light (Intermittent flash method).

With an EX-series Speedlite equipped with an LED light, the LED light will not automatically turn on as the AF-assist light.

 If an external Speedlite's **[AF-assist beam firing]** Custom Function is set to **[Disable]**, this function's setting will be overridden and the AF-assist beam will not be emitted.

**One-Shot AF release priority**

AF3

You can set the AF operation characteristics and shutter-release timing for One-Shot AF.

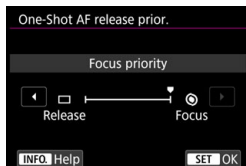
**⦿: Focus priority**

The picture will not be taken until focus is achieved. Useful when you want to achieve focus before capturing the image.

**□: Release priority**

Priority is given to the timing of shutter release instead of achieving focus. This gives priority to capturing the image rather than achieving precise focus.

**Note that the picture will be taken even if focus has not been achieved.**

## AF4

## Lens drive when AF impossible

AF4

If focus cannot be achieved with autofocus, you can have the camera keep searching for the precise focus or have it stop searching.

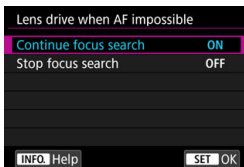
**ON: Continue focus search**

If focus cannot be achieved with autofocus, the lens is driven to search for the precise focus.

**OFF: Stop focus search**

If autofocus starts and the focus is far off or if focus cannot be achieved, the lens drive will not be performed. This prevents the lens from becoming grossly out of focus due to the focus search drive.

 When focus search drive is performed using a super telephoto lenses or other lenses with wide focusing drive ranges, the lens can become grossly out of focus and it may take more time to achieve focus next time. Setting **[Stop focus search]** is recommended.

## Selectable AF point

AF4

You can change the number of manually selectable AF points. With Zone AF, Large Zone AF, or Automatic selection AF set, AF will be performed with the selected AF area selection mode (Zone AF, Large Zone AF, or Automatic selection AF) regardless of the [Selectable AF point] setting.

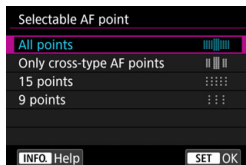
 : **All points**

All AF points will be manually selectable.

 : **Only cross-type AF points**

Only the cross-type AF points will be manually selectable. The number of selectable AF points will vary depending on the lens used.



 : **15 points**

Fifteen major AF points will be manually selectable.

 : **9 points**

Nine major AF points will be manually selectable.

 With a lens in groups G to K (p.118-121), the number of manually selectable AF points will be lower.

-  • Even with settings other than [All points], AF point expansion (manual selection ) , AF point expansion (manual selection, surrounding points), Zone AF, and Large Zone AF are still possible.
- When you press the  button, the AF points that are not manually selectable will not be displayed in the viewfinder.

## Select AF area selection mode

AF4

You can limit the selectable AF area selection modes to suit your shooting preferences. Select the desired selection mode and press <[SET]> to add a checkmark [✓]. Then select [OK] to register the setting. The AF area selection modes are explained on pages 109-111.

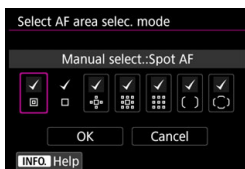

- : **Manual select.:Spot AF**
- : **Manual selection:1 pt AF**
- : **Expand AF area:**
- : **Expand AF area:Surround**
- : **Manual select.:Zone AF**
- : **Manual select.:Large Zone AF**
- : **Auto selection AF**







- The [✓] mark cannot be removed from [Manual selection:1 pt AF].
- If the attached lens belongs to group I, J or K, you cannot use certain AF area selection modes even if you add a [✓] in [Select AF area selec. mode] (p.119 - 121).

## AF area selection method

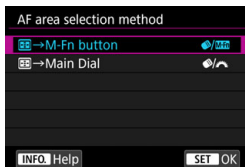

AF4



You can set the method for changing the AF area selection mode.

 /  :  → **M-Fn button**

After you press the  button, pressing the  (AF area selection) button or  button changes the AF area selection mode.

 /  :  → **Main Dial**

After you press the  button, pressing the  (AF area selection) button or turning the  dial changes the AF area selection mode.

 When  → **Main Dial** is set, use the  to move the AF point horizontally.

## Orientation linked AF point

AF4

You can set the AF point or the AF area selection mode + AF point separately for vertical shooting and horizontal shooting.

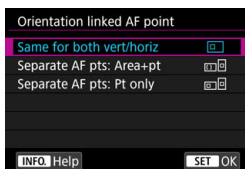
 : **Same for both vert/horiz**

The same AF area selection mode and manually-selected AF point (or zone) are used for both vertical shooting and horizontal shooting.



### : **Separate AF pts: Area+pt**

The AF area selection mode and AF point (or zone) can be set separately for each camera orientation (1. Horizontal, 2. Vertical with the camera grip at the top, 3. Vertical with the camera grip at the bottom).

When you manually select the AF area selection mode and AF point (or zone) for each of the three camera orientations, they will be registered for the respective orientation. Whenever you change the camera orientation during shooting, the camera will switch to the AF area selection mode and manually-selected AF point (or zone) set for that orientation.

### : **Separate AF pts: Pt only**

The AF point can be set separately for each camera orientation (1. Horizontal, 2. Vertical with the camera grip at the top, 3. Vertical with the camera grip at the bottom). While using the same AF area selection mode, the AF point will switch automatically for the respective camera orientation.

When you manually select the AF point for each of the three camera orientations, it will be registered for the respective orientation. During shooting, the AF point will switch to the manually-selected one depending on the camera orientation. Even if you change the AF area selection mode to Manual select.:Spot AF, Manual selection:1 pt AF, Expand AF area: , or Expand AF area: Surround, the AF point set for the respective orientation will be retained.

If you change the AF area selection mode to Zone AF or Large Zone AF, the zone will switch to the manually-selected one for the respective camera orientation.



- If you clear the camera settings to their defaults (p.77), the setting will be **[Same for both vert/horiz]**. Also, your settings for the three camera orientations (1, 2 and 3) will be cleared and all three will revert to Single-point AF with the center AF point selected.
- If you set this and later attach a lens from a different AF group (p.115-121, particularly group I, J, or K), the setting may be cleared.

Initial AF Point,  AI Servo AF

AF4

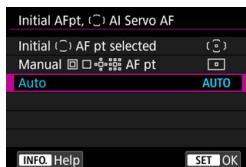

You can set the AI Servo AF's starting AF point for when the AF area selection mode is set to Auto selection AF.

: Initial AF pt selected

AI Servo AF will start with the manually-selected AF point when the AF operation is set to AI Servo AF and the AF area selection mode is set to Auto selection AF.

: Manual AF pt

If you switch from Manual select.:Spot AF, Manual selection:1 pt AF, Expand AF area:, or Expand AF area:Surround to Auto selection AF, AI Servo AF will start with the AF point that was manually selected before the switch. Useful if you want AI Servo AF to start with the AF point that was selected before the AF area selection mode was switched to Auto selection AF.

After setting the AF area selection mode to Auto selection AF with the [ 3: Custom Controls] menu's [**Metering and AF start**] (p.500), [**Switch to registered AF func.**] (p.502) or [**Register/recall shooting func**] (p.508), during shooting with Manual select: Spot AF, Manual selection: 1 pt AF, Expand AF area:, or Expand AF area: Surround, you can press the assigned button to start shooting with Auto selection AF set for the AI Servo AF using the last used AF point as the initial AF point.

**AUTO: Auto**

The AF point which AI Servo AF starts with is set automatically to suit the shooting conditions.

 When [**Manual AF pt**] is set, AI Servo AF will start with the zone that corresponds to the manually-selected AF point even if you switch AF area selection mode to Zone AF or Large Zone AF.

## Auto AF point selection: EOS iTR AF

AF4

EOS iTR\* AF performs autofocus by recognizing faces and subject colors. EOS iTR AF works when the AF area selection mode is set to Zone AF, Large Zone AF, or Automatic selection AF.

\* intelligent Tracking and Recognition: a function that identifies the subject with the metering sensor in order for the AF points to track it.

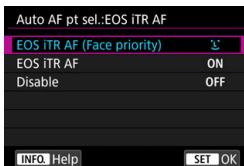

### EOS iTR AF (Face priority)

The AF point is automatically selected based not only on AF information, but also the human face and the subject's color information.

With AI Servo AF, the subject is tracked while giving higher priority to using face information than with the [EOS iTR AF] setting. This makes it easier to keep track of the subject than when only AF information is available.

In One-Shot AF mode, EOS iTR AF makes focusing on human faces easier, so you can shoot while concentrating on the composition.

### ON: EOS iTR AF

The AF point is automatically selected based not only on AF information, but also the human face and the subject's color information. With AI Servo AF, the subject is tracked giving weight to the information not only on the face information but also on where (AF point) the focus was first achieved. The One-Shot AF operation will be the same as with the [EOS iTR AF (Face priority)] setting.

### OFF: Disable

AF points are automatically selected based only on AF information. (The AF does not use the face information or the subject's color information.)

- If [EOS iTR AF (Face priority)] or [EOS iTR AF] is set, the camera may take longer to focus than when [Disable] is set.
- Even if you set [EOS iTR AF (Face priority)] or [EOS iTR AF], the expected effect may not be obtained depending on the shooting conditions and subject.
- Under light so low that the EOS-dedicated, external Speedlite emits the AF-assist beam automatically, AF points are selected automatically based only on AF information.
- Face detection may not work if the face is small or under low-light conditions.

## AF5

### AF point selection movement

AF5

You can set either to stop the selection at the outer edge or it can cycle around to the opposite side in AF point selection.

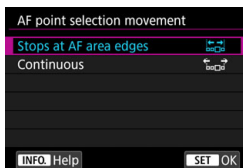



#### : Stops at AF area edges

Useful if you often use an AF point along the edge.

#### : Continuous

Instead of stopping at the outer edge, the selection of AF point continues to the opposite side.





 With [AF4: Initial AF pt,  AI Servo AF] set to [Initial  AF pt selected], the above setting will also work when you are selecting the initial AF point for AI Servo AF.

## AF point display during focus

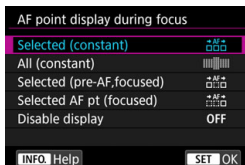
AF5

You can set whether to display the AF point(s) when AF starts, during AF, when focus is achieved, and when the metering timer is active after focus is achieved.



-  : **Selected (constant)**
-  : **All (constant)**
-  : **Selected (pre-AF,focused)**
-  : **Selected AF pt (focused)**
- OFF: Disable display**

○ : Displayed, × : Not displayed

AF point display during focus	With AF point selected	Before AF starts (Camera shooting-ready)	At AF start
Selected (constant)	○	○	○
All (constant)	○	○	○
Selected (pre-AF,focused)	○	○	○
Selected AF pt (focused)	○	×	○
Disable display	○	×	×

AF point display during focus	During AF	Focus achieved	Metering active after achieving focus
Selected (constant)	○	○	○
All (constant)	○	○	○
Selected (pre-AF,focused)	×	○	○
Selected AF pt (focused)	×	○	×
Disable display	×	×	×

## VF display illumination

AF5

You can set whether the AF points in the viewfinder are to light up in red when focus is achieved.

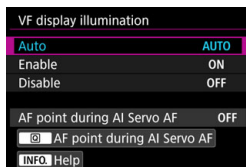
**AUTO: Auto**

The AF points achieving focus in low light or with a dark subject will automatically light up in red.

**ON: Enable**

The AF points light up in red regardless of the ambient light level.

**OFF: Disable**

The AF points do not light up in red.

With [**Auto**] or [**Enable**] set, by pressing the [**Q**] button, you can set whether the AF point is to light up in red during AI Servo AF.

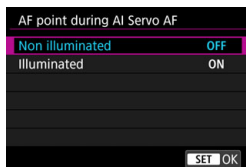
**OFF: Non illuminated**

The AF points will not light up during AI Servo AF.

**ON: Illuminated**

The AF points used for focusing light up in red during AI Servo AF. The AF points also light up during continuous shooting.

This function will not work if [**VF display illumination**] is set to [**Disable**].

- When you press the <[**Q**]> button, the AF points will light up in red regardless of this setting.
- The electronic level and grid in the viewfinder and the information set with [**Show/hide in viewfinder**] (p.84) will also light up in red.

**AF status in viewfinder**

AF5

You can display the AF status icon indicating AF operation either inside or outside of the viewfinder's field of view.

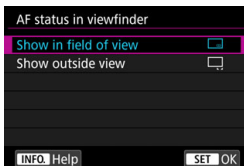

**Show in field of view**

The AF status icon <AF> is displayed in the lower right of the viewfinder's field of view.

**Show outside view**

The <▲▼> icon is displayed below the focus indicator <●> outside the viewfinder's field of view.

 See page 103 for the AF operation display.
**AF Microadjustment**

AF5

You can make fine adjustments for the AF's point of focus. For details, see "Fine Adjustment of AF's Point of Focus" on the next page.

## MENU Fine Adjustment of AF's Point of Focus <sup>☆</sup>

Fine adjustment of the AF's point of focus is possible for viewfinder shooting. This is called "AF Microadjustment". Before making the adjustment, read "General Cautions for AF Microadjustment" and "Notes for AF Microadjustment" on page 157.

**!** Normally, this adjustment is not required. Perform this adjustment only if necessary. Note that performing this adjustment may prevent accurate focusing from being achieved.

### Adjust All by Same Amount

Set the adjustment amount manually by repeatedly making adjustments, shooting, and checking the results until the desired result is achieved. During AF, regardless of the lens used, the point of focus will always be shifted by the adjustment amount.

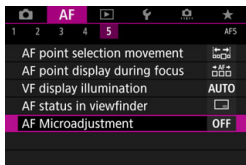

#### 1 Select [AF Microadjustment].

- Under the [AF5] tab, select [AF Microadjustment], then press <SET>.

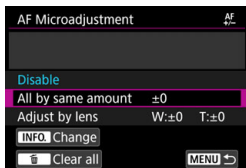

#### 2 Select [All by same amount].

#### 3 Press the <INFO.> button.

- The [All by same amount] screen will appear.



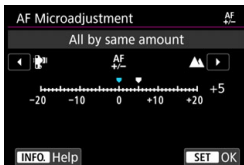



## 4 Make the adjustment.

- Set the adjustment amount. The adjustable range is  $\pm 20$  steps.
- Setting it toward “-: 

 A screenshot of the camera's AF Microadjustment menu. At the top, it says "AF Microadjustment" with "AF" and a small icon to the right. Below that, "All by same amount +5" is selected and highlighted in pink. Underneath, it says "Adjust by lens W:±0 T:±0". At the bottom, there are buttons for "INFO Change", "Clear all", and "MENU" with a right arrow.

## 5 Check the result of the adjustment.

- Take a picture and play back the image (p.394) to check the adjustment result.
- If the shooting result comes out with focus in front of the targeted point, adjust toward the “+: 

 If **[All by same amount]** is selected, separate AF adjustment will not be possible for the wide-angle and telephoto ends of zoom lenses.

## Adjust by Lens

You can make the adjustment for each lens and register the adjustment in the camera. You can register the adjustment for up to 40 lenses. When you autofocus with a lens whose adjustment is registered, the point of focus will always be shifted by the adjustment amount. Set the adjustment amount manually by repeatedly making adjustments, shooting, and checking the results until the desired result is achieved. If you use a zoom lens, make the adjustment for the wide-angle (W) and telephoto (T) ends.



1 Select **[Adjust by lens]**.

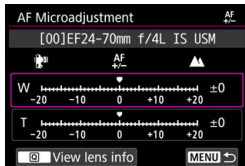

2 Press the **<INFO.>** button.

- ▶ The **[Adjust by lens]** screen will appear.



Registered number

3 Check and change the lens information.

### Displaying the Lens Information

- Press the **<Q>** button.
- ▶ The screen will show the lens name and a 10-digit serial number. When the serial number is displayed, select **[OK]** and go to step 4.
- If the lens's serial number cannot be confirmed, "0000000000" will be displayed. In this case, enter the number by following the instructions on the next page.
- Regarding the asterisk "\*" displayed in front of some lens serial numbers, see the next page.

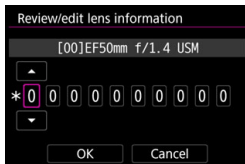

## Entering the Serial Number

- Select the digit to be entered, then press < (SET) > so < ( ) > is displayed.
- Enter the number, then press < (SET) >.
- After entering all the digits, select [OK].

## Lens Serial Number

- **In step 3, if “ \* ” appears in front of the 10-digit lens serial number, you can register only one unit of the same lens model. Even if you enter the serial number, “ \* ” will remain displayed.**
- **The serial number on the lens may differ from the serial number displayed on the screen in step 3. This is not a malfunction.**
- If the lens serial number includes letters, enter only the numbers.
- If the lens serial number is eleven digits or longer, enter only the last ten digits.
- The location of the serial number varies depending on the lens.
- Certain lenses may not have a serial number inscribed. To register a lens that has no serial number inscribed, enter any serial number.



- If [Adjust by lens] is selected and an extender is used, the adjustment will be registered for the lens and extender combination.
- If 40 lenses have already been registered, a message will appear. After you select a lens whose registration is to be erased (overwritten), you can register another lens.

## Single focal length lens

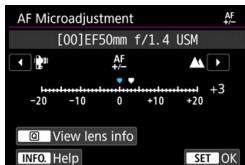

## Zoom lens

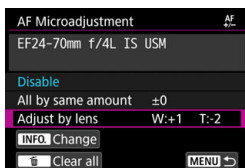
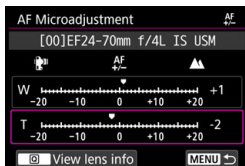

## 4 Make the adjustment.

- For a zoom lens, select the wide-angle (W) or telephoto (T) end. Pressing  $\langle \text{SET} \rangle$  will turn off the purple frame and make the adjustment possible.
- Set the adjustment amount, then press  $\langle \text{SET} \rangle$ . The adjustable range is  $\pm 20$  steps.
- Setting it toward “-: ” will shift the point of focus in front of the standard point of focus.
- Setting it toward “+: ” will shift the point of focus to behind the standard point of focus.
- For a zoom lens, repeat this procedure and adjust it for the wide-angle (W) and telephoto (T) ends.
- After completing the adjustment, press the  $\langle \text{MENU} \rangle$  button to return to the screen in step 1.
- Select [**Adjust by lens**], then press  $\langle \text{SET} \rangle$ .

## 5 Check the result of the adjustment.

- Take a picture and play back the image (p.394) to check the adjustment result.
- If the shooting result comes out with focus in front of the targeted point, adjust toward the “+: ” side. If it comes out with focus behind the targeted point, adjust toward the “-: ” side.
- If necessary, repeat the adjustment.



When shooting with the intermediate range (focal length) of a zoom lens, the AF's point of focus is corrected automatically relative to the adjustments made for the wide-angle and telephoto ends. Even if only the wide-angle or telephoto end is adjusted, a correction will be made automatically for the intermediate range.

## Clearing All AF Microadjustments

When [Clear all] appears at the bottom of the screen, pressing the button will clear all the adjustments made for [All by same amount] and [Adjust by lens].



## General Cautions for AF Microadjustment

- The AF's point of focus will vary slightly depending on the subject conditions, brightness, zoom position, and other shooting conditions. Therefore, even if you perform AF Microadjustment, focus may still not be achieved at the suitable position.
- The adjustment amount of one step varies depending on the maximum aperture of the lens. Keep adjusting, shooting, and checking the focus repeatedly to adjust the AF's point of focus.
- The adjustment will not be applied to AF in Live View shooting or movie shooting.
- The adjustments will be retained even if you clear all the camera settings (p.77). However, the setting itself will be [Disable].



## Notes for AF Microadjustment

- It is best to make the adjustment at the actual location where you will shoot. This will make the adjustment more precise.
- Using a tripod when making the adjustment is recommended.
- For making adjustments, shooting at the image-recording quality is recommended.

## When Autofocus Fails

Autofocus may fail to achieve focus (focus indicator <●> in the viewfinder blinks) with special subjects such as the following:

### Subjects Difficult to Focus

- Subjects with very low contrast  
(Example: Blue skies, solid-color flat surfaces, etc.)
- Subjects in very low light
- Strongly backlit or reflective subjects  
(Example: Cars with highly reflective bodies, etc.)
- Near and distant subjects framed close to an AF point  
(Example: Animals in cages, etc.)
- Subjects such as dots of light framed close to an AF point  
(Example: Night scenes, etc.)
- Subjects with repetitive patterns  
(Example: Skyscraper windows, computer keyboards, etc.)
- Subjects with finer patterns than an AF point  
(Example: Faces or flowers as small as or smaller than an AF point, etc.)

In such cases, focus in either of the following two ways.

- (1) With One-Shot AF, focus on an object at the same distance as the subject and lock the focus, then recompose the shot (p.101).
- (2) Set the lens's focus mode switch to <MF> and focus manually (p.159).



- Depending on the subject, focus may be achieved by slightly recomposing the shot and performing AF operation again.
- For conditions that make focusing difficult with AF during Live View shooting or movie shooting, see page 324.

## MF: Manual Focus

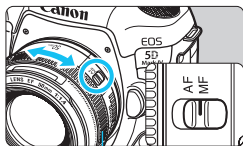

Focusing ring

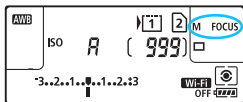

**1 Set the lens's focus mode switch to <MF>.**

- ▶ <M FOCUS> will be displayed on the LCD panel.

**2 Focus on the subject.**

- Focus by turning the lens focusing ring until the subject looks sharp in the viewfinder.



- If you manually focus while pressing the shutter button halfway, the focus indicator <●> will light up when focus is achieved.
- With Automatic selection AF, when the center AF point achieves focus, the focus indicator <●> will light up.

## Selecting the Drive Mode

Single and continuous drive modes are provided. You can select the drive mode suiting the scene or subject.

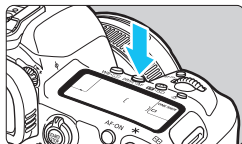

**1** Press the <DRIVE·AF> button (ⓘ6).

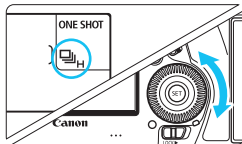

**2** Select the drive mode.

- While looking at the LCD panel or in the viewfinder, turn the <SET> dial.

### : Single shooting

When you press the shutter button completely, only one shot will be taken.

### (H) : High-speed continuous shooting

While you hold down the shutter button completely, you can shoot continuously at **approx. 7.0 shots/sec. maximum**.

However, the maximum continuous shooting speed may become slower under the following conditions:

#### ● With Anti-flicker shooting:

The continuous shooting speed will be **approx. 6.6 shots/sec. maximum**.

#### ● With Dual Pixel Raw shooting:

The continuous shooting speed will be **approx. 5.0 shots/sec. maximum**.

#### ● With Live View shooting:

When [AF operation] is set to [One-Shot AF] and [Silent LV shooting] is set to [Disable], the continuous shooting speed will be **approx. 7.0 shots/sec. maximum**. If [Mode 1] is set, the maximum continuous shooting speed will slightly decrease.

Note that when [AF operation] is set to [Servo AF], the continuous shooting speed of **approx. 4.3 shots/sec. maximum** will be given priority.



● **With the Digital Lens Optimizer set:**

When [Digital Lens Optimizer] is set to [Enable], the continuous shooting speed will greatly decrease.

The maximum continuous shooting speed will vary depending on the shooting conditions. For details, see page 162.

 : **Low-speed continuous shooting**

While you hold down the shutter button completely, you can shoot continuously at **approx. 3.0 shots/sec. maximum**.

During Live View shooting, if [AF operation] is set to [Servo AF], priority will be given to focus tracking on the subject (Subject-tracking priority) with a maximum continuous shooting speed of **approx. 3.0 shots/sec.**

 S : **Silent single shooting**

You can perform single shooting while suppressing the mechanical sound during viewfinder shooting. This cannot be set for Live View shooting.

 S : **Silent continuous shooting**



You can shoot continuously at **approx. 3.0 shots/sec. maximum** while suppressing the mechanical sound during viewfinder shooting (as compared to the  setting). This cannot be set for Live View shooting.

 : **10-sec. self-timer/remote control**

 2 : **2-sec. self-timer/remote control**

For self-timer shooting, see page 163. For remote control shooting, see page 279.

-  The approx. 7.0 shots/sec. maximum high-speed continuous shooting speed <img alt="High-Speed Continuous Shooting icon" data-bbox="128 128 158 148"/> (p.160) is achieved under the following conditions: Fully charged battery pack, 1/500 sec. or faster shutter speed, maximum aperture (varies depending on the lens)\*, at room temperature (23°C / 73°F), flicker reduction disabled, Dual Pixel RAW shooting disabled, Live View shooting with One Shot AF and Silent LV shooting both disabled, and Digital Lens Optimizer disabled.

\* With the AF mode set to One-Shot AF and the Image Stabilizer turned off when using the following lenses: EF300mm f/4L IS USM, EF28-135mm f/3.5-5.6 IS USM, EF75-300mm f/4-5.6 IS USM, EF100-400mm f/4.5-5.6L IS USM.
- The continuous shooting speed for <img alt="High-Speed Continuous Shooting icon" data-bbox="128 318 158 338"/> high-speed continuous shooting may become slower depending on the power source type, battery level, temperature, flicker reduction, Dual Pixel RAW shooting, Digital Lens Optimizer, shutter speed, aperture, subject conditions, brightness, AF operation, lens, flash use, shooting function settings, etc.
- When using the external flash, the maximum continuous shooting speed will become slower.
- With [ 4: Anti-flicker shoot.] set to [Enable] (p.215), shooting under flickering light will decrease the maximum continuous shooting speed. Also, the continuous shooting interval may become irregular and the time lag until the shot is taken may become longer.
- If [ 1: Dual Pixel RAW] is set to [Enable] (p.175) and [ 1: Image-recording quality] is set to [RAW] or [RAW+JPEG] (p.169), the maximum continuous shooting speed will decrease.
- For Live View shooting, if [AF operation] is set to [Servo AF] (p.314), the maximum continuous shooting speed will decrease.
- If [Digital Lens Optimizer] is set to [Enable] (p.210), the continuous shooting speed will greatly decrease.
- With AI Servo AF, the maximum continuous shooting speed may become slower depending on the subject conditions and the lens used.
- If the battery temperature is low due to a low ambient temperature or if the battery level is low, the maximum continuous shooting speed may decrease to approx. 6.0 shots/sec. with the LP-E6N, or to approx. 5.0 shots/sec. with the LP-E6.
- If <img alt="S icon" data-bbox="128 833 158 853"/> or <img alt="S icon" data-bbox="128 833 158 853"/> is set, the time lag from when you press the shutter button completely until the shutter is released will be longer than normal.
- When internal memory becomes full during continuous shooting, the continuous shooting speed may drop off because shooting will be temporarily disabled (p.174).

## 🕒 Using the Self-timer

Use the self-timer when you want to be in the picture such as a commemorative photograph.

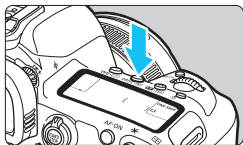

1 Press the <DRIVE-AF> button (📷⚡).

2 Select the self-timer.

- While looking at the LCD panel or in the viewfinder, turn the <📷> dial.

📷🕒 : Shoot in approx. 10 sec.

📷🕒<sub>2</sub> : Shoot in approx. 2 sec.

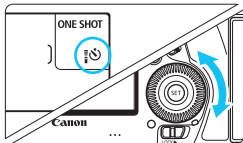

3 Take the picture.

- Look through the viewfinder, focus on the subject, then press the shutter button completely.
- ▶ You can check the self-timer operation with the self-timer lamp, beeper, and countdown display (in seconds) on the LCD panel.
- ▶ Approx. 2 sec. before the picture is taken, the self-timer lamp will light up and the beeper will sound faster.

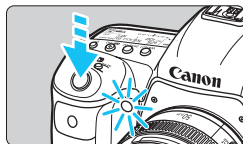

👁️ If you do not look through the viewfinder when you press the shutter button, attach the eyepiece cover (p.278). If stray light enters the viewfinder when the picture is taken, it may throw off the exposure.



- The <📷🕒> enables you to shoot while not touching the camera mounted on a tripod. This prevents camera vibration blur when you shoot still lifes or long exposures.
- After taking self-timer shots, playing back the image (p.394) to check focus and exposure is recommended.
- When using the self-timer to shoot yourself, use focus lock (p.97) on an object at the same distance as where you will stand.
- To cancel the self-timer, press the <DRIVE-AF> button.



# 4

## Image Settings

This chapter explains image-related function settings: Image-recording quality, Dual Pixel RAW function, ISO speed, Picture Style, white balance, Auto Lighting Optimizer, noise reduction, highlight tone priority, lens aberration correction, anti-flicker shooting, and other functions.

- A ☆ icon at the upper right of a page title indicates a function that can be used only in the following modes: <P> <Tv> <Av> <M> <B>.

## MENU Selecting the Card for Recording and Playback

If either a CF card or SD card is already inserted in the camera, you can start recording captured images. When only one card is inserted, you do not have to follow the procedures described on pages 166-168.

If you insert both cards, you can select the recording method and select which card to use for recording and playing back images. [1] indicates the CF card, and [2] the SD card.

### Recording Method with Two Cards Inserted

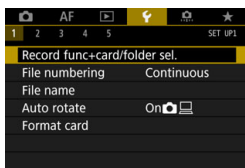

1 Select [Record func+card/folder sel.].

- Under the [1] tab, select [Record func+card/folder sel.], then press <SET>.

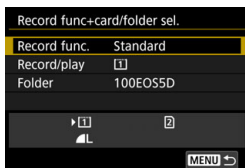

2 Select [Record func.].

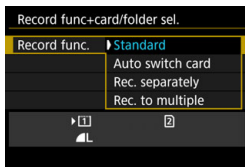

3 Select the recording method.

- Select the recording method, then press <SET>.

- **Standard**

Images will be recorded to the card selected with **[Record/play]**.

- **Auto switch card**

Same as with the **[Standard]** setting, but if the card becomes full, the camera will automatically switch to the other card to record images. When the card is automatically switched, a new folder will be created.

- **Rec. separately**

You can set the image-recording quality for each card (p.169). Each image is recorded to both the CF and SD cards at the image-recording quality you set. You can freely set the image-recording quality, such as to **L** and **RAW**, or **S3** and **M RAW**, etc.

- **Rec. to multiple**

Each image is recorded to both the CF and SD cards simultaneously at the same image-recording quality. You can also select RAW+JPEG.



- If **[Rec. separately]** is set and different recording qualities are set for the CF card and SD card, the maximum burst for continuous shooting will decrease (p.171).
- Movies cannot be recorded simultaneously to the CF card and SD card. Movies will be recorded to the card set for **[Playback]**.



### **[Rec. separately] and [Rec. to multiple]**

- The same file number is used for recording to both the CF card and SD card.
- The LCD panel will display the number of possible shots of the card having the lower number.
- If one of the cards becomes full, **[Card\* full]** will be displayed and shooting will be disabled. If this happens, either replace the card or set **[Record func.]** to **[Standard]**, and select the card with remaining capacity to continue shooting.
- Regarding the **[1: Record func+card/folder sel.]** menu's **[Folder]**, see page 218.

## Selecting the CF or SD Card for Recording and Playback

If **[Record func.]** is set to **[Standard]** or **[Auto switch card]**, select the card for recording and playing back images.

If **[Record func.]** is set to **[Rec. separately]** or **[Rec. to multiple]**, select the card for playing back images.

### Standard / Auto switch card

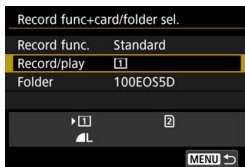

#### Select **[Record/play]**.

- Select **[Record/play]**, then press < (SET) >.  
1 : Record images to and play back images from the CF card.  
2 : Record images to and play back images from the SD card.
- Select the card, then press < (SET) >.

### Rec. separately / Rec. to multiple

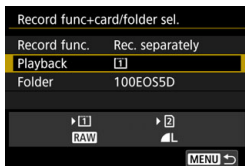

#### Select **[Playback]**.

- Select **[Playback]**, then press < (SET) >.  
1 : Play back the CF card's images.  
2 : Play back the SD card's images.
- Select the card, then press < (SET) >.



## MENU Setting the Image-Recording Quality

You can select the pixel count and the image quality. There are eight JPEG image-recording quality settings: **L**, **L**, **M**, **M**, **S1**, **S1**, **S2**, **S3**. There are three RAW image quality settings: **RAW**, **M RAW**, **S RAW** (p.173).

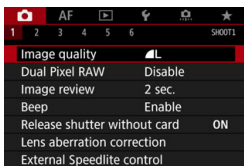

### 1 Select [Image quality].

- Under the [**1**] tab, select [Image quality], then press <SET>.

### Standard / Auto switch card / Rec. to multiple

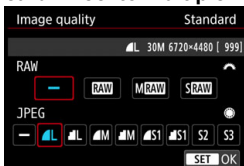

### 2 Select the image-recording quality.

- To select a RAW quality, turn the <DIAL> dial. To select a JPEG quality, turn the <DIAL> dial.
- On the upper right, the “\*\*\*M (megapixels) \*\*\*\*x\*\*\*\*” number indicates the recorded pixel count, and [\*\*\*] is the number of possible shots (displayed up to 9999).
- Press <SET> to set it.
- Under [**1**: Record func+card/ folder sel.], if [Record func.] is set to [Rec. separately], select CF card [1] or SD card [2], then press <SET>.
- Select the desired image-recording quality, then press <SET>.

### Rec. separately

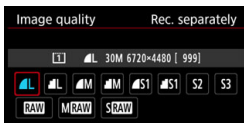
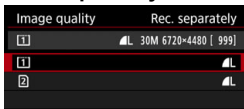

## Image-recording Quality Setting Examples

**L** only

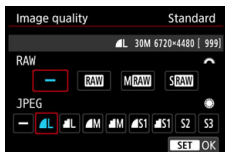

**RAW** only

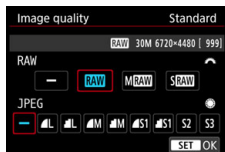

**RAW + L**

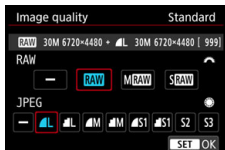

**S RAW + M**

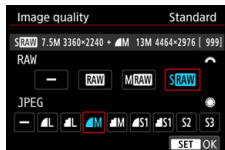

**!** The image size [\*\*\*\*x\*\*\*\*] and number of possible shots [\*\*\*\*] displayed on the Image-recording quality setting screen always apply to the [3:2] setting regardless of the [5: Aspect ratio] setting (p.310).

**!** If [-] is set for both the RAW image and JPEG image, **L** will be set.

## Guide to Image-recording Quality Settings

(Approx.)

Image Quality	Pixels Recorded	Print Size	File Size (MB)	Possible Shots	Maximum Burst			
					CF Card		SD Card	
					Standard	High Speed	Standard	High Speed
<b>JPEG</b>								
L	30 M	A2	8.8	820	110	Full	130	Full
L			4.5	1590	Full	Full	Full	Full
M	13 M	A3	4.7	1530	Full	Full	Full	Full
M			2.4	2970	Full	Full	Full	Full
S1	7.5 M	A4	3.0	2350	Full	Full	Full	Full
S1			1.5	4560	Full	Full	Full	Full
<b>S2</b>	2.5 M	9x13 cm	1.3	5420	Full	Full	Full	Full
<b>S3</b>	0.3 M	–	0.3	20330	Full	Full	Full	Full
<b>RAW</b>								
<b>RAW</b>	30 M	A2	36.8	170	17	21	17	19
<b>RAW : DPR</b>	30 M		66.9	90	7	7	7	7
<b>M RAW</b>	17 M		27.7	220	23	32	23	26
<b>S RAW</b>	7.5 M	A4	18.9	310	35	74	36	48
<b>RAW+JPEG</b>								
<b>RAW</b> L	30 M 30 M	A2 A2	36.8 8.8	140	13	16	13	14
<b>M RAW</b> L	17 M 30 M	A2 A2	27.7 8.8	170	13	17	14	15
<b>S RAW</b> L	7.5 M 30 M	A4 A2	18.9 8.8	220	15	22	15	18



- **S2** is suitable for playing the images on a digital photo frame, etc.
- **S3** is suitable for emailing the image or using it on a Web site.
- **S2** and **S3** will be in (Fine) quality.

- The number of possible shots is based on Canon's testing standards and an 8 GB card.
- The maximum burst is with Canon's standard testing CF card (Standard: 8 GB, High speed: UDMA Mode 7, 64 GB) and SD card (Standard: 8 GB, High speed: UHS-I, 16 GB), and based on the following conditions set by the Canon's testing standard:  High-speed continuous shooting, 3:2 aspect ratio, ISO 100, Dual Pixel RAW shooting disabled, Standard Picture Style, IPTC information not appended.
- **The file size, number of possible shots, and maximum burst will vary depending on the subject, card brand, ISO speed, Picture Style, Custom Functions, and other settings.**
- "Full" indicates that shooting is possible until the card becomes full with the listed conditions.



- Even if you use a UDMA CF card or high-speed SD card, the maximum burst indicator remains the same. However, the maximum burst shown in the table on the preceding page applies to continuous shooting.
- If you select both RAW and JPEG, the same image will be recorded simultaneously to the card in both RAW and JPEG at the image-recording qualities that were set. The two images will be recorded with the same file numbers (file extension: .JPG for JPEG and .CR2 for RAW).
- The image-recording quality icons indicate as follows: **RAW** (RAW), **M RAW** (Medium RAW), **S RAW** (Small RAW), **JPEG** (JPEG), **▲** (Fine), **■** (Normal), **L** (Large), **M** (Medium), and **S** (Small).

## RAW Images

A RAW image is raw data output by the image sensor converted to digital data. It is recorded to the card as is, and you can select the quality as follows: **RAW**, **M RAW**, or **S RAW**.

A **RAW** image can be processed with [ **1: RAW image processing**] (p.446) and saved as a JPEG image. (**M RAW** and **S RAW** images cannot be processed with the camera.) As the RAW image itself does not change, you can process the RAW image to create any number of JPEG images with various processing conditions.

You can use Digital Photo Professional (EOS software, p.598) to process RAW images. You can make various adjustments to images depending upon how they will be used and can generate JPEG, TIFF, or other types of images reflecting the effects of those adjustments.



### RAW Image Processing Software

- To display RAW images on a computer, using Digital Photo Professional (DPP, EOS software) is recommended.
- Previous versions of DPP Ver.4.x cannot process RAW images taken with this camera. If a previous version of DPP Ver.4.x is installed on your computer, update it with the EOS DIGITAL Solution Disk (p.599). (The previous version will be overwritten.) Note that DPP Ver.3.x or earlier cannot process RAW images taken with this camera.
- Commercially-available software may not be able to display RAW images taken with this camera. For compatibility information, contact the software manufacturer.

## One-touch Image Quality Setting <sup>☆</sup>

With Custom Controls, you can assign the image-recording quality to the <M-Fn> button or depth-of-field preview button so you can switch to it momentarily. If you assign [**One-touch image quality setting**] or [**One-touch image quality (hold)**] to the <M-Fn> button or depth-of-field preview button, you can quickly switch to the desired image-recording quality and shoot.

For details, see “Custom Controls” (p.495).

**!** Under [**1: Record func+card/folder sel.**], if [**Record func.**] is set to [**Rec. separately**], you cannot switch to the One-touch image quality setting.

## Maximum Burst for Continuous Shooting

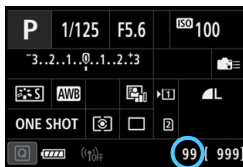

The approximate maximum burst is displayed in the viewfinder and on the bottom right of the Quick Control screen and Custom Quick Control screen. If the maximum burst for continuous shooting is 99 or higher, “99” will be displayed.

**!** The maximum burst is displayed even when a card is not inserted in the camera. Make sure that a card is inserted before taking a picture.

**!** If the maximum burst is displayed as “99”, it indicates that you can shoot 99 or more shots continuously. If the maximum burst decreases to 98 or lower and the internal buffer memory becomes full, “buSY” will be displayed in the viewfinder and on the LCD panel. Shooting will then be disabled temporarily. If you stop continuous shooting, the maximum burst will increase. After all the captured images are written to the card, you can resume continuous shooting and shoot up to the maximum burst listed in the table on page 171.

# Setting the Dual Pixel RAW Function

If you shoot **RAW** images (other than **M RAW** or **S RAW**) when Dual Pixel RAW function is set, they will be recorded as “special **RAW** images (Dual Pixel RAW images)” with Dual Pixel data from the image sensor appended. This is called Dual Pixel RAW shooting.

When you perform processing of the Dual Pixel RAW image with the Digital Photo Professional (EOS software, p.598), you can make use of the Dual Pixel data recorded with the Dual Pixel RAW image for microadjustment of the position of maximum sharpness and resolution using the depth information contained within the file, repositioning the viewpoint or foreground bokeh for a more pleasing result, and reducing the appearance of ghosting in images.

**Since the effect will differ depending on the shooting conditions, refer to the Digital Photo Professional Instruction Manual for the features of Dual Pixel RAW function and Dual Pixel RAW image processing before performing Dual Pixel Raw shooting.**

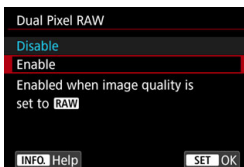
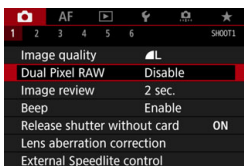

## 1 Select [Dual Pixel RAW].

- Under the [**1**] tab, select [**Dual Pixel RAW**], then press <SET>.

## 2 Select [Enable].

- Press the <INFO.> button and read the Help screen (p.91) before proceeding.
- Select [**Enable**], then press <SET>.

## 3 Set the image-recording quality to **RAW**.

- See page 169, then set the image-recording quality to **RAW** or **RAW+JPEG**.
- ▶ <DPR> will be displayed on the LCD panel.

## 4 Take the picture.

- ▶ A RAW image appended with Dual Pixel data (Dual Pixel RAW image) will be recorded.

- Even if [**📷1: Dual Pixel RAW**] is set to [**Enable**], you cannot record **M RAW** or **S RAW** images appended with the Dual Pixel data (only possible with **RAW** images).
- If [**📷1: Record func+card/folder sel.**] is set to [**Rec. separately**] and the image-recording quality is set to **RAW** for one card and **M RAW** or **S RAW** for the other, Dual Pixel RAW shooting cannot be performed.
- When [**📷1: Dual Pixel RAW**] is set to [**Enable**], you cannot use multiple exposures, HDR shooting, the One-touch image quality setting or Digital Lens Optimizer. Also, the startup time will be longer when the power switch is set to <ON> or to resume from the Auto power off state.
- With Dual Pixel RAW shooting, the number of possible shots will decrease.
- Shooting in Dual Pixel RAW using the viewfinder will decrease the continuous shooting speed. The maximum burst for continuous shooting will also decrease.
- If [**📷1: Dual Pixel RAW**] is set to [**Enable**] for Live View shooting, the <📷H> and <📷> drive modes cannot be selected. If <📷H> or <📷> is set, the <📷> drive mode will apply for shooting.
- In viewfinder shooting with [**📷1: Dual Pixel RAW**] set to [**Enable**], if you switch to Live View shooting while <📷H> or <📷> drive mode is set, the <📷> drive mode will be set automatically.
- When you shoot RAW or RAW+JPEG images with [**📷1: Dual Pixel RAW**] set to [**Enable**], noise may be more noticeable compared with that in normal shooting.

### **Adjustment Amount and Correction Effect of the Dual Pixel RAW Function**

- The adjustment amount and correction effect will increase with a larger aperture.
- The sufficient adjustment amount and correction effect may not be obtained depending on the lens and scene.
- The adjustment amount and correction effect will vary depending on the camera orientation (vertical or horizontal).
- The sufficient adjustment amount and correction effect may not be obtained depending on the shooting conditions.

 <DPR> can be displayed in the viewfinder for Dual Pixel RAW shooting (p.84).



# ISO: Setting the ISO Speed for Still Photos <sup>☆</sup>

Set the ISO speed (image sensor's sensitivity to light) to suit the ambient light level. In the  $\langle \text{A}^+ \rangle$  mode, the ISO speed is automatically set (p.179).

Regarding the ISO speed during movie shooting, see pages 337 and 341.

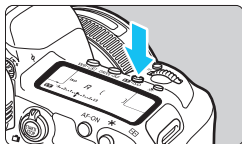

1 Press the  $\langle \text{ISO} \cdot \text{ISO} \rangle$  button ( $\odot 6$ ).

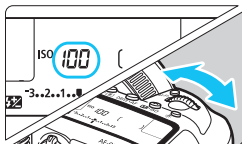

2 Set the ISO speed.

- While looking at the LCD panel or in the viewfinder, turn the  $\langle \text{ISO} \text{ dial} \rangle$  dial.
- ISO speed can be set within ISO 100 - ISO 32000 in 1/3-stop increments.
- "A" indicates ISO Auto. The ISO speed will be set automatically (p.179).

## ISO Speed Guide

ISO Speed	Shooting Situation (No flash)	Flash Range
L (50), ISO 100 - ISO 400	Sunny outdoors	The higher the ISO speed, the farther the effective flash range will be.
ISO 400 - ISO 1600	Overcast skies or evening time	
ISO 1600 - ISO 32000, H1 (51200), H2 (102400)	Dark indoors or night	

\* High ISO speeds will result in grainier images.



You can also set the ISO speed with the [**2: ISO speed settings**] menu's [**ISO speed**] screen.

- As H1 (equivalent to ISO 51200) and H2 (equivalent to ISO 102400) are expanded ISO speed settings, noise (dots of light, banding, etc.) and irregular colors will be more noticeable, and the resolution lower compared with the standard setting.
- As L (equivalent to ISO 50) is an expanded ISO speed setting, the dynamic range will be somewhat narrower compared with the standard setting.
- If [**3: Highlight tone priority**] is set to **[Enable]** (p.206), L (equivalent to ISO 50), ISO 100/125/160, H1 (equivalent to ISO 51200), and H2 (equivalent to ISO 102400) cannot be selected.
- When shooting with a high ISO speed, high temperature, long exposure, or multiple exposure, image noise (rough grain, dots of light, banding, etc.) and irregular colors may become noticeable.
- When shooting in conditions that produce an extreme amount of noise, such as a combination of high ISO speed, high temperature, and long exposure, images may not be recorded properly.
- If you use a high ISO speed and flash to shoot a close subject, overexposure may result.

 Under [**2: ISO speed settings**], you can use **[Range for stills]** to expand the settable ISO speed range from L (equivalent to ISO 50) to H1 (equivalent to ISO 51200) and H2 (equivalent to ISO 102400) (p.180).

## ISO Auto



If the ISO speed is set to “A” (Auto), the actual ISO speed to be set will be displayed when you press the shutter button halfway.

As indicated below, the ISO speed will be set automatically to suit the shooting mode.

Shooting Mode	ISO Speed Setting	
	No Flash	With Flash
<b>A</b> <sup>+</sup>	ISO 100 - ISO 12800	ISO 100 - ISO 1600
<b>P/Tv/Av/M</b>	ISO 100 - ISO 32000 <sup>*1</sup>	ISO 400 <sup>*1*2*3</sup>
<b>B</b>	ISO 400 <sup>*1</sup>	

\*1: The actual ISO speed range depends on the **[Minimum]** and **[Maximum]** settings set in **[Auto range]**.

\*2: If fill-in flash will cause overexposure, ISO 100 or a higher ISO will be set. (Except in the **<M>** and **<B>** modes.)

\*3: In the **<P>** mode, if you use bounce flash with an external Speedlite, ISO 400 - ISO 1600 will be set automatically.

**MENU** Setting the Manually-Settable ISO Speed Range

You can set the manually-settable ISO speed range (minimum and maximum limits). You can set the minimum limit within L (equivalent to ISO 50) to H1 (equivalent to ISO 51200), and the maximum limit within ISO 100 to H2 (equivalent to ISO 102400).

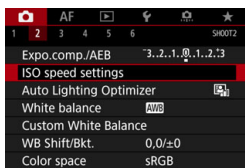
**1** Select [ISO speed settings].

- Under the [CAMERA] tab, select [ISO speed settings], then press <SET>.

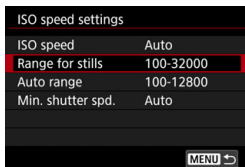
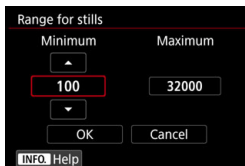
**2** Select [Range for stills].**3** Set the minimum limit.

- Select the minimum limit box, then press <SET>.
- Select the ISO speed, then press <SET>.

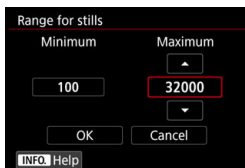
**4** Set the maximum limit.

- Select the maximum limit box, then press <SET>.
- Select the ISO speed, then press <SET>.

**5** Select [OK].

## **MENU** Setting the ISO Speed Range for ISO Auto

You can set the automatic ISO speed range for ISO Auto within ISO 100 - ISO 32000. You can set the minimum limit within ISO 100 - ISO 25600, and the maximum limit within ISO 200 - ISO 32000 in whole-stop increments.

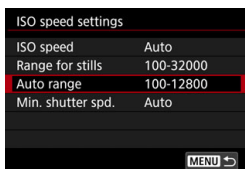

### 1 Select [Auto range].

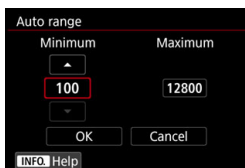

### 2 Set the minimum limit.

- Select the minimum limit box, then press <SET>.
- Select the ISO speed, then press <SET>.

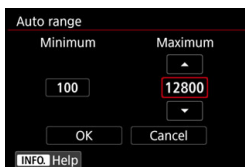

### 3 Set the maximum limit.

- Select the maximum limit box, then press <SET>.
- Select the ISO speed, then press <SET>.

### 4 Select [OK].

The **[Minimum]** and **[Maximum]** settings will also be applied to the minimum and maximum ISO speeds of the safety shift effected by the ISO speed (p.485).

**MENU** Setting the Minimum Shutter Speed for ISO Auto

You can set the minimum shutter speed so that the shutter speed set automatically will not be too slow when ISO Auto is set.

This is effective in the <P> and <Av> modes when you use a wide-angle lens to shoot a moving subject or when you use a telephoto lens. It helps to reduce camera shake and blurred subjects.

ISO speed settings	
ISO speed	Auto
Range for stills	100-32000
Auto range	100-12800
Min. shutter spd.	Auto

## 1 Select [Min. shutter spd.].

## Automatically set

Min. shutter spd.	
Auto(Standard)	
Auto	
Manual	
Slower	Faster

## 2 Set the desired minimum shutter speed.

- Select [Auto] or [Manual].
- If you select [Auto], turn the < > dial to set the desired speed, slower or faster compared to the standard speed, then press < >.
- If you select [Manual], turn the < > dial to select the shutter speed, then press < >.

## Manually set

Min. shutter spd.				
Manual(1/125)				
Auto				
Manual				
1/8000	1/4000	1/2000	1/1000	1/500
1/250	1/125	1/60	1/30	1/15
1/8	1/4	0.5	1"	

- If a correct exposure cannot be obtained with the maximum ISO speed limit set with [Auto range], a shutter speed slower than the [Min. shutter spd.] will be set to obtain the standard exposure.
- This function will not be applied to flash and movie shooting.

When [Auto: 0] is set, the minimum shutter speed will be the reciprocal of the lens focal length. A single step from [Slower] to [Faster] is equivalent to a single shutter speed stop.

## Selecting a Picture Style ☆

By selecting a Picture Style, you can obtain image characteristics matching your photographic expression or the subject.

In the <A+> mode, the Picture Style is set automatically to [A] (Auto).



1 Press the  $\langle A+ \rangle$  button.

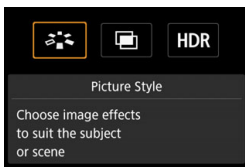

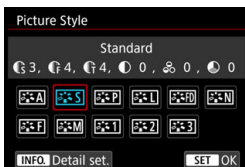

2 Select [].

▶ The Picture Style selection screen will appear.



3 Select a Picture Style.

▶ The Picture Style will be set and the camera will be ready to shoot.

 You can also set this with the [3: Picture Style] screen.

## Picture Style Characteristics

### **Auto**

The color tone will be adjusted automatically to suit the scene. The colors will look vivid for blue skies, greenery and sunsets, particularly in nature, outdoor and sunset scenes.

 If the desired color tone is not obtained with **[Auto]**, use another Picture Style.

### **Standard**

The image looks vivid, sharp, and crisp. This is a general-purpose Picture Style suitable for most scenes.

### **Portrait**

For nice skin tones. The image looks softer. Suited for close-up portraits.

By changing the **[Color tone]** (p.188), you can adjust the skin tone.

### **Landscape**

For vivid blues and greens, and very sharp and crisp images. Effective for impressive landscapes.

### **Fine Detail**

Suited for detailed outline and fine texture description of the subject. The colors will be slightly vivid.

### **Neutral**

Suited for processing the image with a computer. For natural colors and subdued images with modest brightness and color saturation.



 **Faithful**

Suited for processing the image with a computer. The color of a subject that is captured in sunlight at a color temperature of 5200K will be adjusted to match the subject's colorimetric color. For subdued images with modest brightness and color saturation.

 **Monochrome**

Creates black-and-white images.



Black-and-white images shot in JPEG cannot be turned into color. Be careful not to leave the **[Monochrome]** setting on when you want to shoot photos in color again.



You can set the camera to display <M> in the viewfinder and on the LCD panel for when **[Monochrome]** is set (p.489).

 **User Def. 1-3**

You can register a basic style such as **[Portrait]**, **[Landscape]**, a Picture Style file, etc. and adjust it as desired (p.190). Any User Defined Picture Style that is not set will have the same settings as the default setting of the **[Standard]** Picture Style.

## Symbols

The Picture Style selection screen has icons for **[Strength]**, **[Fineness]**, or **[Threshold]** for **[Sharpness]** as well as **[Contrast]**, and other parameters. The numerals indicate the values for these parameters set for the respective Picture Style.

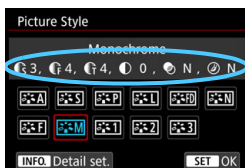
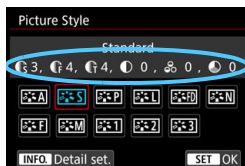

## Symbols

●	Sharpness	
	●	Strength
	●	Fineness
	●	Threshold
●	Contrast	
●	Saturation	
●	Color tone	
●	Filter effect (Monochrome)	
●	Toning effect (Monochrome)	

During movie shooting, “\*” will be displayed for both **[Fineness]** and **[Threshold]** for **[Sharpness]**. **[Fineness]** and **[Threshold]** will not be applied to movies.

## Customizing a Picture Style ☆

You can customize the Picture Styles. You can change or adjust the parameter settings of Picture Styles such as **[Strength]**, **[Fineness]**, or **[Threshold]** for **[Sharpness]** as well as **[Contrast]** and other parameters from the default settings. To see the resulting effects, take test shots. To customize **[Monochrome]**, see page 189.

### 1 Press the button.

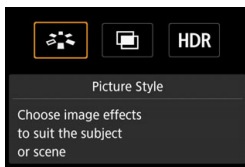

### 2 Select .

- ▶ The Picture Style selection screen will appear.

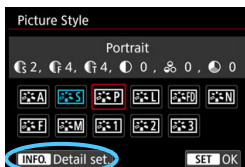

### 3 Select a Picture Style.

- Select a Picture Style, then press <INFO.> button.

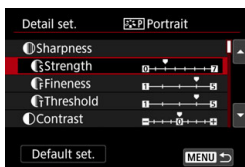

### 4 Select a parameter.

- Select the parameter (such as **[Strength]** of **[Sharpness]**) to be set, then press .
- The settings and effects are explained on the next page.



## 5 Set the parameter.

- Adjust the level of effect (parameter) as desired, then press **<SET>**.
- Press the **<MENU>** button to save the adjusted parameter settings. The Picture Style selection screen will reappear.
- ▶ The value of parameter settings different from the default will be displayed in blue.

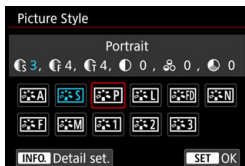

## Parameter Settings and Effects

●	Sharpness		
	● Strength	0: Weak outline emphasis	7: Strong outline emphasis
	● Fineness*1	1: Fine	5: Grainy
	● Threshold*2	1: Low	5: High
●	Contrast	-4: Low contrast	+4: High contrast
●	Saturation	-4: Low saturation	+4: High saturation
●	Color tone	-4: Reddish skin tone	+4: Yellowish skin tone

\*1: Indicates the fineness of the outlines to be emphasized. The smaller the number, the finer the outlines that can be emphasized.

\*2: Sets how much the outline is emphasized based on the difference in contrast between the subject and the surrounding area. The smaller the number, the more the outline will be emphasized when the contrast difference is low. However, noise tends to be more noticeable when the number is smaller.

- For movie shooting, **[Fineness]** and **[Threshold]** for **[Sharpness]** cannot be set (not displayed).
- By selecting **[Default set.]** in step 4, you can revert the parameter settings of the respective Picture Style to their defaults.
- To shoot with the Picture Style you adjusted, first select the adjusted Picture Style, then shoot.

## Monochrome Adjustment

Besides the effects described on the preceding page such as **[Contrast]**, or **[Strength]**, **[Fineness]** and **[Threshold]** for **[Sharpness]**, you can also set **[Filter effect]** and **[Toning effect]**.

### Filter effect

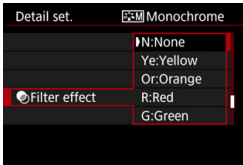

With a filter effect applied to a monochrome image, you can make white clouds or green trees stand out more.

Filter	Sample Effects
N: None	Normal black-and-white image with no filter effects.
Ye: Yellow	The blue sky will look more natural, and the white clouds will look crisper.
Or: Orange	The blue sky will look slightly darker. The sunset will look more brilliant.
R: Red	The blue sky will look quite dark. Fall leaves will look crisper and brighter.
G: Green	Skin tones and lips will appear muted. Green tree leaves will look crisper and brighter.

 Increasing the **[Contrast]** will make the filter effect more pronounced.

### Toning effect

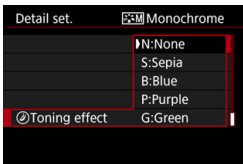

By applying a toning effect, you can create a monochrome image in the selected color. Effective when you want to create more impressive images. The following can be selected: **[N:None]**, **[S:Sepia]**, **[B:Blue]**, **[P:Purple]** or **[G:Green]**.

## Registering a Picture Style ☆

You can select a base Picture Style such as [Portrait] or [Landscape], adjust its parameters as desired and register it under [User Def. 1], [User Def. 2], or [User Def. 3]. Useful when you want to preset multiple Picture Styles with different settings.

You can also adjust the parameters of a Picture Style that is registered to the camera with EOS Utility (EOS software, p.598).

**1** Press the  button.

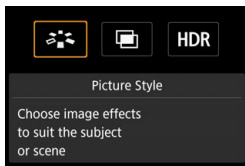

**2** Select .

- ▶ The Picture Style selection screen will appear.

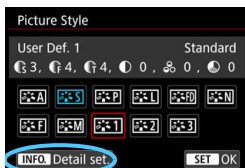

**3** Select [User Def. \*].

- Select [User Def. \*], then press the <INFO.> button.

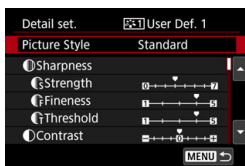

**4** Press <SET>.

- With [Picture Style] selected, press <SET>.

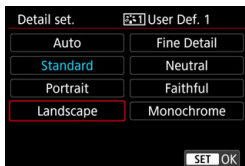

**5** Select the base Picture Style.

- Select the base Picture Style, then press <SET>.
- To adjust the parameters of a Picture Style that is registered to the camera with EOS Utility (EOS software), select the Picture Style here.

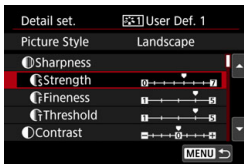

## 6 Select a parameter.

- Select the parameter (such as **[Strength]** of **[Sharpness]**) to be set, then press **<SET>**.



## 7 Set the parameter.

- Adjust the level of effect (parameter) as desired, then press **<SET>**. For details, see “Customizing a Picture Style” (p.187).
- Press the **<MENU>** button to register the adjusted parameter settings. The Picture Style selection screen will then reappear.
- ▶ The base Picture Style will be indicated on the right of **[User Def. \*]**.

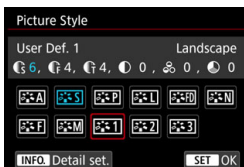

- If a Picture Style is already registered under **[User Def. \*]**, changing the base Picture Style in step 5 will clear the parameter settings of the previously registered User Defined Picture Style.
- If you perform **[Y5: Clear all camera settings]** (p.77), all the **[User Def. \*]** styles and settings will revert to their defaults.



- To shoot with the Picture Style you adjusted, select the registered **[User Def. \*]**, then shoot.
- Regarding the procedure to register a Picture Style file to the camera, refer to the EOS Utility Instruction Manual (p.600).

## WB: Setting the White Balance ☆

White balance (WB) is for making the white areas look white. Normally, the Auto [AWB] (Ambience priority) or [AWB w] (White priority) setting will obtain the correct white balance. If natural-looking colors cannot be obtained with Auto, you can select the white balance to match the light source or set it manually by shooting a white object.

In the <A+> mode, [AWB] (Ambience priority) is automatically set.

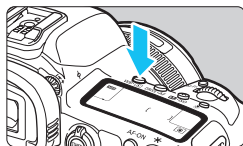

1 Press the <WB> button (ⓘ6).

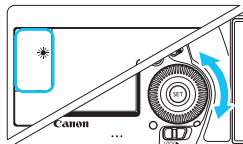

2 Select a white balance setting.

- While looking at the LCD panel or in the viewfinder, turn the <WB> dial.

(Approx.)

Display	Mode	Color Temperature (K: Kelvin)
[AWB]	Auto (Ambience priority, p.194)	3000 - 7000
[AWB w]	Auto (White priority, p.194)	
☀	Daylight	5200
🏠	Shade	7000
☁	Cloudy, twilight, sunset	6000
☀	Tungsten light	3200
💡	White fluorescent light	4000
⚡	Flash use	Automatically set*
📷	Custom (p.195)	2000 - 10000
[K]	Color temperature (p.197)	2500 - 10000

\* Applicable with Speedlites having a color temperature transmission function. Otherwise, it will be fixed to approx. 6000 K.





- You can also set this with the [📷2: White balance] screen.
- To switch between Auto [AWB] (Ambience priority) and [AWB w] (White priority), use the [📷2: White balance] screen (p.194).

## White Balance

To the human eye, a white object looks white regardless of the type of lighting. With a digital camera, the white for color correction basis is decided depending on the color temperature of the illumination, and then the color is adjusted with software to make the white areas look white. With this function, pictures with natural color tones can be taken.

**AWB Auto White Balance**

With [**AWB**] (Ambience priority), you can increase the intensity of the image's warm color cast when shooting a tungsten-light scene. If you select [**AWB w**] (White priority), you can reduce the intensity of the image's warm color cast.

If you want to match the Auto white balance of previous EOS DIGITAL camera models, select [**AWB**] (Ambience priority).

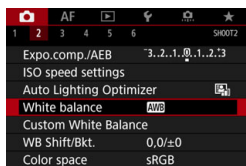
**1 Select [White balance].**

- Under the [**2**] tab, select [**White balance**], then press <SET>.

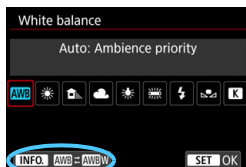
**2 Select [AWB].**

- With [**AWB**] selected, press the <INFO.> button.

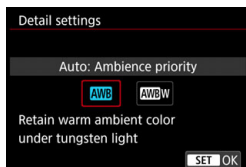
**3 Select the desired item.**

- Select [**Auto: Ambience priority**] or [**Auto: White priority**], then press <SET>.

**AWB** : Auto: Ambience priority

**AWB w** : Auto: White priority

**! Cautions for Setting [AWB w] (White priority)**

- The warm color cast of subjects may fade.
- When multiple light sources are included on the screen, the warm color cast of the picture may not be lessened.
- When using flash, the color tone will be the same as with [**AWB**] (Ambience priority).

## Custom White Balance

With custom white balance, you can manually set the white balance for the specific light source of the shooting location. Make sure to perform this procedure under the light source at the actual location of the shoot.

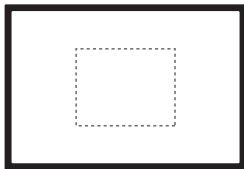

### 1 Shoot a white object.

- Look through the viewfinder and aim the entire dotted line box (shown in the illustration) over a plain, white object.
- Focus manually and shoot with the standard exposure set for the white object.
- You can use any white balance setting.

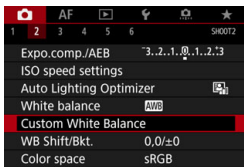

### 2 Select [Custom White Balance].

- Under the [2] tab, select [Custom White Balance], then press <SET>.
- ▶ The custom white balance selection screen will appear.



### 3 Import the white balance data.

- Turn the < > dial to select the image captured in step 1, then press <SET>.
- ▶ On the dialog screen that appears, select [OK] and the data will be imported.
- Press the <MENU> button to exit the menu.

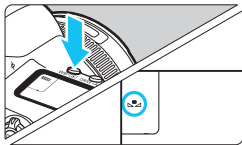

**4** Press the **<WB>** button (ⓘ6).

**5** Select the custom white balance.

- Look at the LCD panel and turn the **<DIAL>** dial to select **<CUSTOM>**.

- If the exposure obtained in step 1 differs greatly from the standard exposure, a correct white balance may not be obtained.
- In step 3, the following images cannot be selected: Images captured with the Picture Style set to **[Monochrome]**, multiple-exposure images, frame-grab images from 4K movies, and images shot with another camera.

- Instead of a white object, shooting a gray chart or standard 18% gray reflector (commercially-available) can produce a more accurate white balance.
- The personal white balance registered with the EOS software will be registered under **<CUSTOM>**. If you perform step 3, the data for the registered personal white balance will be erased.

## **K** Setting the Color Temperature

You can set the white balance's color temperature numerically. This is for advanced users.

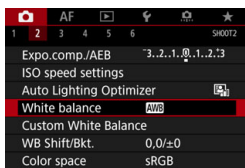

### 1 Select [White balance].

- Under the [**2**] tab, select [White balance], then press <SET>.

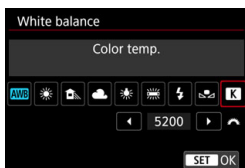

### 2 Set the color temperature.

- Select [**K**].
- Turn the <DIAL> dial to set the color temperature, then press <SET>.
- The color temperature can be set from approx. 2500 K to 10000 K in 100 K increments.



- When setting the color temperature for an artificial light source, set white balance correction (magenta or green) as necessary.
- If you set [**K**] to the reading taken with a commercially-available color temperature meter, take test shots and adjust the setting to compensate for the difference between the color temperature meter's reading and the camera's color temperature reading.

# WB $\pm$ White Balance Correction ☆

You can correct the white balance that is set. This adjustment will have the same effect as using a commercially-available color temperature conversion filter or color compensating filter. Each color can be corrected to one of nine levels.

This function is for advanced users, particularly for those users who understand the use of color temperature conversion and color compensating filters and their effects.

## White Balance Correction

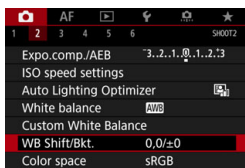

### 1 Select [WB Shift/Bkt.].

- Under the [CAMERA] tab, select [WB Shift/Bkt.], then press <SET>.

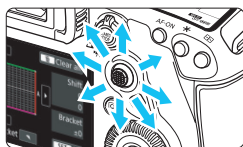

### 2 Set the white balance correction.

- Use <M/AF-ON> to move the "■" mark to the appropriate position.
- B is for blue, A for amber, M for magenta, and G for green. The image's color balance will be adjusted toward the color in the direction of the move.
- On the right of the screen, "Shift" indicates the direction and correction amount, respectively.
- Pressing the <DISP/OK> button will cancel all the [WB Shift/Bkt.] settings.
- Press <SET> to exit the setting.

Sample setting: A2, G1

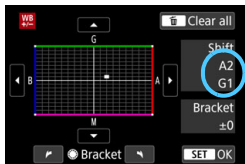

- You can set the camera to display <WB> in the viewfinder and on the LCD panel for when white balance correction has been set (p.489).
- One level of the blue/amber correction is equivalent to approx. 5 mireds of a color temperature conversion filter. (Mired: Unit of measure for color temperature used to indicate values such as the density of a color temperature conversion filter.)

## White Balance Auto Bracketing

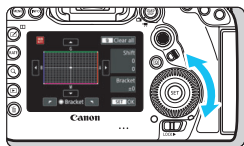

With just one shot, three images with different color tones can be recorded simultaneously. Based on the color temperature of the current white balance setting, the image will be bracketed with a blue/amber bias and magenta/green bias. This function is called white balance bracketing (WB-BKT). White balance bracketing is possible up to  $\pm 3$  levels in single-level increments.

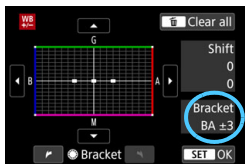

B/A bias  $\pm 3$  levels



### Set the white balance bracketing amount.

- In step 2 for “White Balance Correction”, when you turn the  dial, the “■” mark on the screen will change to “■■■” (3 points). Turning the dial to the right sets the B/A bracketing, and turning it to the left sets the M/G bracketing.
- ▶ On the right, “Bracket” indicates the bracketing direction and correction amount.
- Pressing the  button will cancel all the [WB Shift/Bkt.] settings.
- Press  to exit the setting.

### ● Bracketing Sequence

The images will be bracketed in the following sequence: 1. Standard white balance, 2. Blue (B) bias, and 3. Amber (A) bias, or 1. Standard white balance, 2. Magenta (M) bias, and 3. Green (G) bias.

- During white balance bracketing, the maximum burst for continuous shooting will be lower.
- Since three images are recorded for one shot, it takes longer to record the image to the card.

- You can also set white balance correction and AEB together with white balance bracketing. If you set AEB in combination with white balance bracketing, a total of nine images will be recorded for a single shot.
- When white balance bracketing is set, the white balance icon will blink.
- You can change the sequence (p.483) and number of shots (p.484) for the white balance bracketing.
- “**Bkt.**” stands for bracketing.



## MENU Auto Correction of Brightness and Contrast ☆

If the image comes out dark or the contrast is low, the brightness and contrast can be corrected automatically. This function is called Auto Lighting Optimizer. The default setting is [Standard]. With JPEG images, the correction is applied when the image is captured.

In the <[A+]> mode, [Standard] is automatically set.

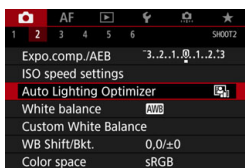

### 1 Select [Auto Lighting Optimizer].

- Under the [CAMERA] tab, select [Auto Lighting Optimizer], then press <[SET]>.

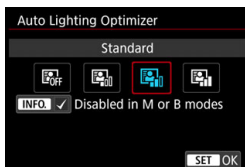

### 2 Select the setting.

- Select the desired setting, then press <[SET]>.

### 3 Take the picture.

- The image will be recorded with the brightness and contrast corrected if necessary.

- Depending on the shooting conditions, noise may increase.
- If the effect of Auto Lighting Optimizer is too strong and the image is too bright, set [Low] or [Disable].
- If a setting other than [Disable] is set and you use exposure compensation or flash exposure compensation to darken the exposure, the image may still come out bright. If you want a darker exposure, set this function to [Disable].
- When you set multiple exposures (p.268), HDR mode (p.263), or highlight tone priority (p.206), [Auto Lighting Optimizer] will be automatically set to [Disable].

In step 2, if you press the <[INFO]> button and remove the [✓] mark for [Disabled in M or B modes] setting, the [Auto Lighting Optimizer] can be set even in the <[M]> and <[B]> modes.

## MENU Setting Noise Reduction ☆

### High ISO Speed Noise Reduction

This function reduces the noise generated in the image. Although noise reduction is applied at all ISO speeds, it is particularly effective at high ISO speeds. When shooting at low ISO speeds, the noise in the darker parts of the image (shadow areas) can further be reduced.

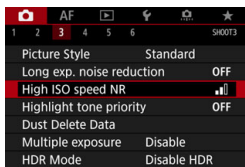

#### 1 Select [High ISO speed NR].

- Under the [**3**] tab, select [**High ISO speed NR**], then press <SET> >.

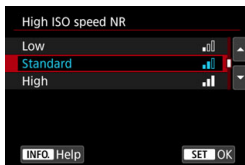

#### 2 Set the level.

- Select the desired noise reduction level, then press <SET> >.

#### ● [NR] : Multi Shot Noise Reduction

This applies noise reduction with higher image quality than [**High**].

For a single photo, four shots are taken continuously and aligned and merged automatically into a single JPEG image.

If the image-recording quality is set to RAW or RAW+JPEG, you cannot set [**Multi Shot Noise Reduction**].

#### 3 Take the picture.

- The image will be recorded with noise reduction applied.

 You can set to display <●> in the viewfinder and on the LCD panel for when Multi Shot Noise Reduction is set (p.489).



## Cautions for Setting Multi Shot Noise Reduction

- If there is significant misalignment in the image due to camera shake, the noise reduction effect may become smaller.
- If you are handholding the camera, keep it steady to prevent camera shake. Using a tripod is recommended.
- If you shoot a moving subject, the moving subject may leave afterimages.
- The image alignment may not function properly with repetitive patterns (lattice, stripes, etc.) or flat, single-tone images.
- If the subject's brightness changes as the four consecutive shots are taken, irregular exposure in the image may result.
- After shooting, it may take some time to record an image to the card after performing noise reduction and merging the images. During the processing of the images, "buSY" will be displayed in the viewfinder and on the LCD panel, and you cannot take another picture until the processing is completed.
- You cannot use AEB and WB bracketing.
- If [**3: Long exp. noise reduction**], [**3: Multiple exposure**], [**3: HDR Mode**], Dual Pixel RAW shooting, AEB shooting, WB bracketing, or Live View shooting with Servo AF is set, [**Multi Shot Noise Reduction**] cannot be set.
- This cannot be set for bulb shooting.
- Flash shooting is not possible. Note that the AF-assist beam of EOS-dedicated, external Speedlites will be emitted according to the [**AF3: AF-assist beam firing**] setting.
- Doing any of the following will automatically switch the setting to [**Standard**]: Setting the power switch to <**OFF**>, replacing the battery, replacing the card, selecting the <**A**<sup>+</sup>> or <**B**> shooting mode, setting or switching the image-recording quality to RAW or RAW+JPEG, or switching to movie shooting.

## Long Exposure Noise Reduction

For images exposed for 1 sec. or longer, noise (dots of light and banding) typical of long exposures can be reduced.

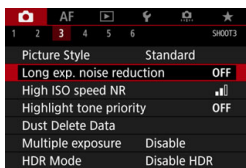

### 1 Select [Long exp. noise reduction].

- Under the [**3**] tab, select [**Long exp. noise reduction**], then press < (SET) >.

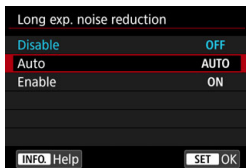

### 2 Set the desired setting.

- Select the desired setting, then press < (SET) >.

#### • Auto

For exposures of 1 sec. or longer, noise reduction is performed automatically if noise typical of long exposures is detected. This [**Auto**] setting is effective in most cases.

#### • Enable

Noise reduction is performed for all exposures of 1 sec. or longer. The [**Enable**] setting may reduce noise that cannot be detected with the [**Auto**] setting.

### 3 Take the picture.

- The image will be recorded with noise reduction applied.



- With **[Auto]** or **[Enable]** set, the noise reduction process after the picture is taken may take the same amount of time as that for the exposure. During noise reduction, shooting is still possible as long as the maximum burst indicator in the viewfinder shows “1” or higher.
- Images taken at high ISO speeds may look grainier with the **[Enable]** setting than with the **[Disable]** or **[Auto]** setting.
- With **[Enable]** set, if a long exposure is shot with the Live View image displayed, “**BUSY**” will be displayed during the noise reduction process. The Live View display will not appear until the noise reduction is completed. (You cannot take another picture.)

## MENU Highlight Tone Priority ☆

You can reduce overexposed, clipped highlights.

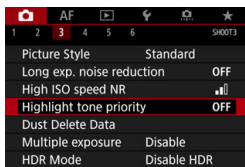

### 1 Select [Highlight tone priority].

- Under the [**3**] tab, select [Highlight tone priority], then press < **SET** >.

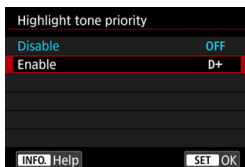

### 2 Select [Enable].

- Highlight details are improved. The dynamic range is expanded from the standard 18% gray to bright highlights. The gradation between the grays and highlights becomes smoother.

### 3 Take the picture.

- The image will be recorded with highlight tone priority applied.

- When [Enable] is set, noise may increase slightly.
- With [Enable], the settable ISO speed range will start from ISO 200. Expanded ISO speeds cannot be set.
- When you set multiple exposures (p.268) or HDR mode (p.263), [Highlight tone priority] will be automatically set to [Disable].

When highlight tone is set, <D+> is displayed in the viewfinder and on the LCD panel.

## MENU Correction of Lens Aberrations due to Optical Characteristics ☆

Peripheral light fall-off is a phenomenon that makes the image corners look darker due to the optical characteristics of the lens. Image distortion due to optical characteristics of the lens is called distortion. Color fringing along subject outlines is called chromatic aberration. And decreased image sharpness due to the aperture is called diffraction phenomenon. These lens aberrations can be corrected. The Digital Lens Optimizer can correct the various aberrations caused by optical characteristics of the lens, diffraction phenomenon, and the deterioration of resolution caused by the low-pass filter.

By default, the [**Peripheral illum corr**], [**Chromatic aberr corr**], and [**Diffraction correction**] are set to [**Enable**], [**Distortion correction**] and [**Digital Lens Optimizer**] is set to [**Disable**].

If the lens correction data is registered (saved) in the camera, peripheral illumination correction, chromatic aberration correction, and diffraction correction will be done even in the <[A]<sup>+</sup>> mode.

If the setting screen displays [**Correction data not available**] or the [ ] icon, it means that the correction data for the respective lens is not registered in the camera. See “Lens Correction Data” on page 213.

### Peripheral Illumination Correction

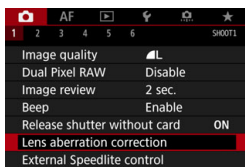

#### 1 Select [**Lens aberration correction**].

- Under the [1] tab, select [**Lens aberration correction**], then press <[SET]>.

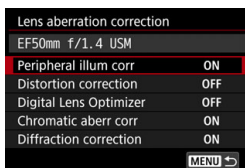

#### 2 Select [**Peripheral illum corr**].

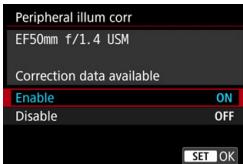

### 3 Select [Enable].

- Check that [**Correction data available**] is displayed for the attached lens.
- Select [**Enable**], then press <  >.

### 4 Take the picture.

- The image will be recorded with the peripheral illumination corrected.

- Depending on shooting conditions, noise may appear on the image periphery.
- The higher the ISO speed, the lower the correction amount will be.

 The correction amount applied will be slightly lower than the maximum correction amount that can be applied with Digital Photo Professional (EOS software, p.598).



## Distortion Correction

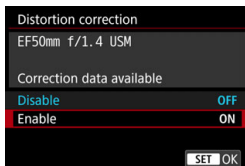

### 1 Select [Distortion correction].

### 2 Select [Enable].

- Check that [**Correction data available**] is displayed for the attached lens.
- Select [**Enable**], then press <SET>.

### 3 Take the picture.

- The image will be recorded with the distortion corrected.



- When distortion correction is enabled, the camera records an image range narrower than the one seen through the viewfinder. (The image periphery is slightly trimmed and the resolution looks slightly lowered.)
- During movie shooting, [**Distortion correction**] will not be displayed (correction is not possible).
- Using distortion correction during Live View shooting will slightly affect the angle of view.
- When you magnify the image during Live View shooting, distortion correction is not applied to the image displayed. Therefore, magnifying the periphery of the image may display parts of the image that will not be recorded.
- Images with distortion correction applied will not have the Dust Delete Data (p.460) appended. Also, the AF point(s) will not be displayed (p.402) for image playback.

## Digital Lens Optimizer

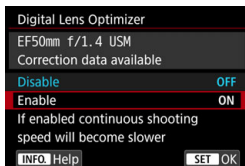

1 Select [Digital Lens Optimizer].

2 Select [Enable].

- Check that [Correction data available] is displayed for the attached lens.
- Select [Enable], then press <SET>.

3 Take the picture.

- The image will be recorded with the following being corrected: lens aberrations, diffraction phenomenon, and the deterioration of resolution caused by the low-pass filter.

- Depending on shooting conditions, noise may be intensified with the effects of correction. Also, stronger application of outline emphasis may result. In such a case, adjust the Picture Style's Sharpness as necessary.
- The higher the ISO speed, the lower the correction amount will be.
- If the image-recording quality is set to **M RAW** or **S RAW** and you set [Digital Lens Optimizer] to [Enable], the image-recording quality will be **RAW**.
- If [Digital Lens Optimizer] is set to [Enable], the continuous shooting speed will greatly decrease. Also, **M RAW** and **S RAW** cannot be set for the image-recording quality. If a correction is made during Live View shooting, [BUSY] will be displayed and the Live View image will not be displayed until the correction process is completed. (Another Live View shooting is not possible.)
- If [Digital Lens Optimizer] is set to [Enable], and you set [Dual Pixel RAW] to [Enable], [Digital Lens Optimizer] will not function. (The setting will be switched to [Disable].)
- During movie shooting, [Digital Lens Optimizer] will not be displayed (correction is not possible).
- If [Digital Lens Optimizer] is set to [Enable], Multi Shot Noise Reduction cannot be set. Also, even if you assign a button to switch the image-recording quality to **M RAW** or **S RAW** with [One-touch image quality setting] or [One-touch image quality (hold)] in Custom Controls, that Custom Control function will not take effect.



- When [**Digital Lens Optimizer**] is set to [**Enable**], [**Chromatic aberr corr**] and [**Diffraction correction**] will not be displayed, but both will be set to [**Enable**] for shooting.
- The <C> icon can be displayed in the viewfinder (p.84) by adding a checkmark [✓] to [**Digital Lens Optimizer**] in [**Viewfinder display**].
- The Digital Lens Optimizer's correction data for newly released lenses can be added with EOS Utility (EOS software, p.598).
- If [**Invalid correction data for Digital Lens Optimizer.**] is displayed, use EOS Utility (EOS software) to add the correction data for the Digital Lens Optimizer to the camera.

## Chromatic Aberration Correction

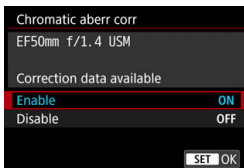

### 1 Select [**Chromatic aberr corr**].

### 2 Select [**Enable**].

- Check that [**Correction data available**] is displayed for the attached lens.
- Select [**Enable**], then press <SET>.

### 3 Take the picture.

- The image will be recorded with the chromatic aberration corrected.



If [**Digital Lens Optimizer**] is set to [**Enable**], [**Chromatic aberr corr**] will not be displayed.

## Diffraction Correction

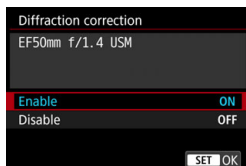

1 Select [**Diffraction correction**].

2 Select [**Enable**].

- Select [**Enable**], then press <SET>.

3 Take the picture.

- The image will be recorded with the diffraction corrected.

- Depending on shooting conditions, noise may be intensified with the effects of correction.
- The higher the ISO speed, the lower the correction amount will be.
- For movie shooting, [**Diffraction correction**] will not appear (correction is not possible).

- With “Diffraction correction”, degraded resolution due to the low-pass filter, etc. is corrected in addition to diffraction. Therefore, correction is effective even near the maximum aperture.
- If [**Digital Lens Optimizer**] is set to [**Enable**], [**Diffraction correction**] will not be displayed.

## Lens Correction Data

The lens correction data for lens aberration corrections is registered (stored) in the camera. With **[Enable]** selected, the peripheral illumination correction, distortion correction, Digital Lens Optimizer, chromatic aberration correction, and diffraction correction will be applied automatically.

With EOS Utility (EOS software, p.598), you can check which lenses have their correction data registered in the camera. You can also register the correction data for unregistered lenses. For details, refer to the EOS Utility Instruction Manual (p.600).

For lenses incorporating the correction data, it is not necessary to register the correction data to the camera.

 **Cautions for Lens Correction**

- Peripheral illumination correction, distortion correction, chromatic aberration correction, and diffraction correction cannot be applied to JPEG images already taken.
- When using a non-Canon lens, setting the corrections to **[Disable]** is recommended even if **[Correction data available]** is displayed.
- If you use magnified view during Live View shooting, the peripheral illumination correction and distortion correction will not be reflected in the image on the screen. Note that the Digital Lens Optimizer and diffraction correction will not be applied to the Live View image.
- The correction amount will be less (except for diffraction correction) if the lens used does not have distance information.

 **Notes for Lens Correction**

- The effect of the lens aberration correction varies depending on the lens used and shooting conditions. Also, the effect may be difficult to discern depending on the lens used, shooting conditions, etc.
- If the correction is difficult to discern, magnifying and checking the image after shooting is recommended.
- Corrections can be applied even when an extender or life-size converter is attached.
- If the correction data for the attached lens is not registered to the camera, the result will be the same as when the correction is set to **[Disable]** (except for diffraction correction).

## MENU Reducing Flicker ☆

If you shoot an image with a fast shutter speed under a light source such as fluorescent light, the blinking of the light source causes flicker and the image may be vertically unevenly exposed. If continuous shooting is used under these conditions, uneven exposures or colors across the images may result. When you use this feature during viewfinder shooting, the camera detects the flickering frequency of the light source and takes the picture when the flicker causes less effect on exposure or color tone.

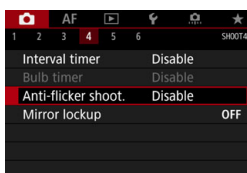

### 1 Select [Anti-flicker shoot.].

- Under the [**4**] tab, select [**Anti-flicker shoot.**], then press <SET>.

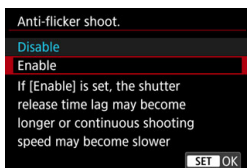



### 2 Select [Enable].

### 3 Take the picture.

- The image will be taken with reduced unevenness of exposure or color tone caused by the flicker.

- When [**Enable**] is set and you shoot under a flickering light source, the shutter-release time lag may become longer. Also, the continuous shooting speed may become slower, and the shooting interval may become irregular.
- This function does not work with mirror lockup, Live View shooting, or movie shooting.
- In the <**P**> or <**Av**> mode, if the shutter speed changes during continuous shooting or if you shoot multiple shots of the same scene at different shutter speeds, the color tone may be inconsistent. To avoid inconsistent color tones, use the <**Tv**> or <**M**> mode at a fixed shutter speed.
- The color tone of the captured images when [**Anti-flicker shoot.**] is set to [**Enable**] may look different from when [**Disable**] is set.
- Flicker at a frequency other than 100 Hz or 120 Hz cannot be detected. Also, if the flickering frequency of the light source changes during continuous shooting, effects of the flicker cannot be reduced.

- 
  - If the subject is against a dark background or if there is a bright light in the image, flicker may not be properly detected.
  - Under certain special types of lighting, the camera may not be able to reduce the effects of the flicker even when < **Flicker!** > is displayed.
  - Depending on the light source, flicker may not be detected properly.
  - If you recompose a shot, < **Flicker!** > may appear and disappear intermittently.
  - Depending on the light sources or shooting conditions, the expected result may not be obtained even if you use this function.
  
- 
  - Taking test shots in advance is recommended.
  - If < **Flicker!** > is not displayed in the viewfinder, add a checkmark to [**Flicker detection**] in [**Show/hide in viewfinder**] (p.84). If you shoot with flicker reduction, < **Flicker!** > will light up. Under a light source which does not flicker, or if no flicker is detected, < **Flicker!** > will not be displayed.
  - If a checkmark is added to [**Flicker detection**] and [**4: Anti-flicker shoot.**] is set to [**Disable**], metering under a flickering light source will cause < **Flicker!** > to blink in the viewfinder as a warning. Setting to [**Enable**] before shooting is recommended.
  - In the < **A+** > mode, < **Flicker!** > will not be displayed, but the picture will be taken with flicker reduction.
  - Flicker reduction also works with flash. However, the expected result may not be obtained for wireless flash shooting.



## MENU Setting the Color Space ☆

The range of reproducible colors is called “color space”. With this camera, you can set the color space for captured images to sRGB or Adobe RGB. For normal shooting, sRGB is recommended.

In the <[A+]> mode, the color space is set automatically to [sRGB].

### 1 Select [Color space].

- Under the [CAMERA 2] tab, select [Color space], then press <[SET]>.

### 2 Set the desired color space.

- Select [sRGB] or [Adobe RGB], then press <[SET]>.

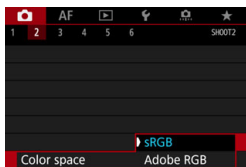

## Adobe RGB

This color space is mainly used for commercial printing and other industrial uses. This setting is not recommended if you are not familiar with image processing, Adobe RGB, and Design rule for Camera File System 2.0 (Exif 2.21 or higher). The image will look very subdued in a sRGB computer environment and with printers not compliant to Design rule for Camera File System 2.0 (Exif 2.21 or higher). Post-processing of the image with computer software will therefore be required.



- If the captured still photo was shot in the Adobe RGB color space, the first character in the file name will be an underscore “\_”.
- The ICC profile is not appended. For explanations about the ICC profile, refer to the Digital Photo Professional Instruction Manual (p.600).

## MENU Creating and Selecting a Folder

You can freely create and select the folder where the captured images are to be saved.

This operation is optional since a folder will be created automatically for saving captured images.

### Creating a Folder

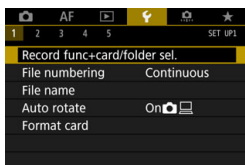

#### 1 Select [Record func+card/folder sel.].

- Under the [1] tab, select [Record func+card/folder sel.], then press <SET>.

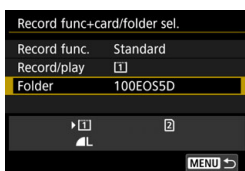

#### 2 Select [Folder].

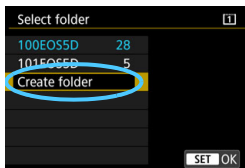

#### 3 Select [Create folder].

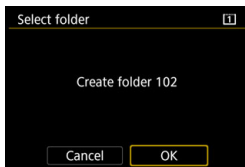

#### 4 Select [OK].

- A new folder with the folder number increased by one is created.

## Selecting a Folder



- Select a folder on the folder selection screen, then press < (SET) >.
- ▶ The folder where the captured images will be saved is selected.
- Subsequently captured images will be recorded into the selected folder.



### Folders

As with “100EOS5D” for example, the folder name starts with three digits (the folder number) followed by five alphanumeric characters. A folder can contain up to 9999 images (file number 0001 - 9999). When a folder becomes full, a new folder with the folder number increased by one is created automatically. Also, if manual reset (p.224) is executed, a new folder will be created automatically. Folders numbered from 100 to 999 can be created.

### Creating Folders with a Computer

With the card open on the screen, create a new folder named “DCIM”. Open the DCIM folder and create as many folders as necessary to save and organize your images. The folder name must follow the format “100ABC\_D”. The first three digits are always the folder number from 100 to 999. The last five characters can be any combination of upper- and lower-case letters from A to Z, numerals, and the underscore “\_”. The space cannot be used. Also note that two folder names cannot share the same three-digit folder number (for example, “100ABC\_D” and “100W\_XYZ”) even if the remaining five characters in each name are different.

## MENU Changing the File Name

The file name has four alphanumeric characters followed by a four-digit image number (p.223) and extension.

(Example) BE3B0001.JPG

The first four alphanumeric characters

are set upon factory shipment and unique to the camera. However, you can change them.

With “User setting1”, you can change and register the four characters as desired. With “User setting2”, if you register three characters, the fourth character from the left will be appended automatically to indicate the image size (image-recording quality).

### Registering or Changing the File Name

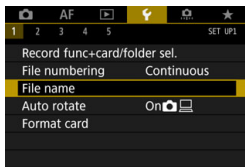

#### 1 Select [File name].

- Under the [**1**] tab, select [**File name**], then press < **SET** >.

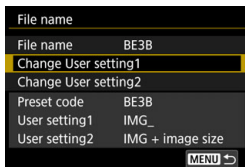

#### 2 Select [Change User setting\*].



Character palette

#### 3 Enter any alphanumeric characters.

- For User setting1, enter four characters. For User setting2, enter three characters.
- Press the < **DELETE** > button to delete any unnecessary characters.

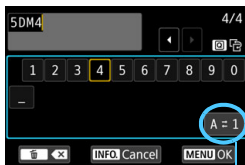

Input mode

- Operate the <☉>, <☀>, or <☼> to move the  and select the desired character. Then press <SET> to enter it.
- By selecting [A ⇄ 1], you can change the input mode.
- To cancel the text entry, press the <INFO.> button, then select [OK].

## 4 Exit the setting.

- After entering the correct number of characters, press the <MENU> button, then select [OK].
- ▶ The registered file name will be saved.

## 5 Select the registered file name.

- Select [File name], then press <SET>.
- Select the registered file name, then press <SET>.
- If User setting2 is registered, select “\*\*\* (the 3 characters registered) + image size”.

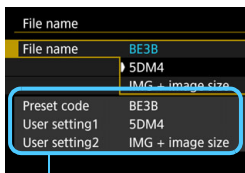

Settings



The first character cannot be an underscore “\_”.



## User setting2

When you select the “\*\*\* + image size” registered with User setting2 and take pictures, the image-recording quality character will be automatically appended as the file name’s fourth character from the left. The meaning of the image-recording quality characters is as follows:

“\*\*\*L” = L / L / RAW

“\*\*\*M” = M / M / M RAW

“\*\*\*S” = S1 / S1 / S RAW

“\*\*\*T” = S2

“\*\*\*U” = S3

When the image is transferred to a computer, you can refer to the fourth character of the image file name to identify the image size (image-recording quality) without opening the image. RAW or JPEG images can be distinguished with the extension.



- If you cannot enter text in step 3, press the <[Q]> button and use the character palette when the blue frame appears.
- The extension will be “.JPG” for JPEG images, “.CR2” for RAW images, and “.MOV” or “.MP4” for movies.
- When you shoot a movie with User setting2, the file name’s fourth character will be an underscore “\_”.

## MENU File Numbering Methods

The captured images are assigned a sequential four-digit file number from 0001 (Example) **BE3B0001.JPG** to 9999 and saved in one folder. You can change how the file number is assigned.

File numbering

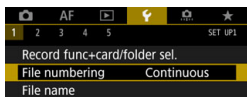

### 1 Select [File numbering].

- Under the [**1**] tab, select [**File numbering**], then press <[SET]>.

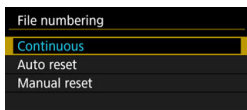

### 2 Select the file numbering method.

- Select the desired setting, then press <[SET]>.
- With [**Manual reset**] selected, selecting [**OK**] will reset the image numbering to 0001.

## Continuous

**Continues the file numbering sequence even after the card is replaced or a new folder is created.**

Even after you replace the card, create a folder, or switch the target card (such as [1] → [2]), the file numbering continues in sequence up to 9999 for the images saved. This is useful when you want to save images numbered anywhere between 0001 to 9999 on multiple cards or in multiple folders into one folder on a computer.

If the replacement card or existing folder already contains images recorded previously, the file numbering of the new images may continue from the file numbering of the existing images on the card or in the folder. If you want to use continuous file numbering, it is recommended that you use a newly-formatted card each time.

File numbering after replacing the card

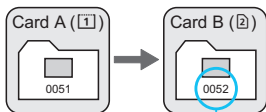

Next sequential file number

File numbering after creating a folder

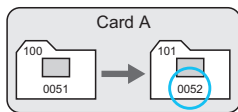

## Auto Reset

**Restarts the file numbering from 0001 each time the card is replaced or a new folder is created.**

When you replace the card, create a folder, or switch the target card (such as ① → ②), the file numbering continues in sequence from 0001 for the images saved. This is useful if you want to organize images by cards or folders.

If the replacement card or existing folder already contains images recorded previously, the file numbering of the new images may continue from the file numbering of the existing images on the card or in the folder. If you want to save images with the file numbering starting from 0001, use a newly formatted card each time.

**File numbering after replacing the card**

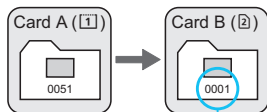

File numbering is reset

**File numbering after creating a folder**

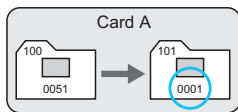

## Manual Reset

**Resets the file numbering to 0001 or starts from file number 0001 in a new folder.**

When you reset the file numbering manually, a new folder is created automatically and the file numbering of images saved to that folder starts from 0001.

This is useful, for example, if you want to use different folders for the images taken yesterday and the ones taken today. After the manual reset, the file numbering returns to continuous or auto reset.

 If the file number in folder 999 reaches 9999, shooting will not be possible even if the card still has storage capacity. The LCD monitor will display a message telling you to replace the card. Replace it with a new card.



## MENU Setting Copyright Information ☆

When you set the copyright information, it will be recorded to the image as Exif information.

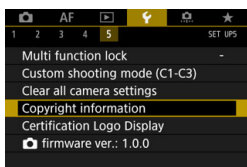

### 1 Select [Copyright information].

- Under the [**5**] tab, select [**Copyright information**], then press <SET>.

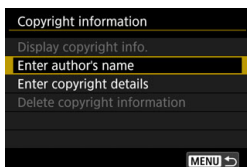

### 2 Select the option to be set.

- Select [**Enter author's name**] or [**Enter copyright details**], then press <SET>.

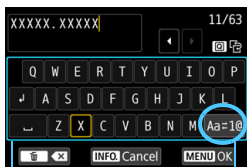

Character palette

Input mode

### 3 Enter text.

- Operate the <⊙>, <☀>, or <⊕> to move the  and select the desired character. Then press <SET> to enter it.
- You can enter up to 63 characters.
- To delete a character, press the <🗑> button.
- By selecting [**Aa↔1@**], you can change the input mode.
- To cancel the text entry, press the <INFO.> button, then select [OK].

### 4 Exit the setting.

- After entering the text, press the <MENU> button, then select [OK].
- ▶ The information is saved.

## Checking the Copyright Information

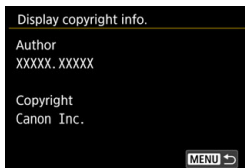

When you select [**Display copyright info.**] in step 2, you can check the [**Author**] and [**Copyright**] information that you entered.

## Deleting the Copyright Information

When you select [**Delete copyright information**] in step 2, you can delete the [**Author**] and [**Copyright**] information.

 If the entry for “Author” or “Copyright” is long, it may not be displayed entirely when you select [**Display copyright info.**].

- 
- If you cannot enter text in step 3, press the <[Q]> button and use the character palette when the blue frame appears.
  - You can also set or check the copyright information with EOS Utility (EOS software, p.598).

# 5

## GPS Settings

This chapter explains the camera's built-in GPS settings. The EOS 5D Mark IV (WG) can receive satellite navigation signals from GPS satellites (USA), GLONASS satellites (Russia), and Quasi-Zenith Satellite System (QZSS) "Michibiki" (Japan).

- The GPS function is set to **[Disable]** by default.
- This manual uses the term "GPS" to refer to the satellite navigation function.

When **[GPS]** is set to **[Mode 1]** (p.231), the camera will continue to receive GPS signals at regular intervals even after the camera's power switch is set to **<OFF>**. The battery will thereby drain faster and the number of possible shots will decrease. If you will not use GPS, setting **[GPS]** to **[Disable]** or **[Mode 2]** is recommended.

 When using GPS function, be sure to check the region of use and use the function in accordance with the laws and regulations of the country or region. Be particularly careful when using GPS outside your home country.

# GPS Features

## Geotagging Images

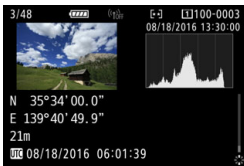

- Geotag information<sup>\*1</sup> (latitude, longitude, elevation) and coordinated universal time<sup>\*2</sup> can be appended to images.
- Shooting locations of geotagged images can be displayed on a map on a computer.

\*1: Certain travel conditions or GPS settings may cause inaccurate geotag information to be added to images.

\*2: Coordinated Universal Time, abbreviated as UTC, is essentially the same as Greenwich Mean Time.

## Logging the Route Traveled

You can use the GPS logging function to automatically record the route the camera travels by logging location information at set intervals. The location information for the route the camera has traveled can be viewed on a map displayed on a computer.

\* Certain traveling conditions, locations, or GPS settings may cause inaccurate geotag information to be added to images.

## Setting the Camera Time

The time information obtained from GPS signals can be set on the camera.

 The GPS information recorded to the images and movies may include information that can personally identify yourself. Therefore, be careful when giving geotagged still photos or movies to other people or displaying them online to the public.

## Viewing Images and Information on a Virtual Map

With Map Utility (EOS software, p.599), you can view the shooting locations and the route traveled on a map displayed on a computer.

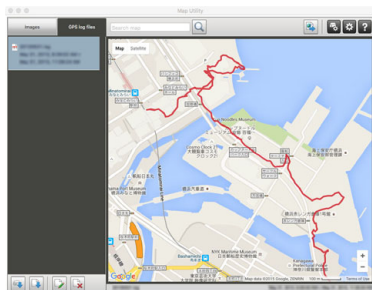

Map data ©2016 ZENRIN

# GPS Precautions

## ■ Countries and Regions Permitting GPS Function Use

Use of GPS function is restricted in some countries and regions, and illegal use may be punishable under national or local regulations. To avoid violating GPS function regulations, visit the Canon Web site to check where the use is allowed.

Note that Canon cannot be held liable for any problems arising from GPS function use in other countries and regions.

## ■ Model Number

EOS 5D Mark IV (WG) : DS126601  
(including GPS module model: ES300)

- In certain countries and regions, the use of GPS function may be restricted. Therefore, be sure to use GPS function in accordance with the laws and regulations of your country or region. Be particularly careful when using GPS function outside your home country.
- Be careful about using GPS function where the operation of electronic devices is restricted.
- Others may be able to locate or identify you by using location data in your geotagged pictures or movies. Be careful when sharing these geotagged images, movies or GPS log files with others, such as when posting them online where many people can view them.
- GPS signal reception may take a longer time in some cases.

Hereby, Canon Inc., declares that this DS126601 is in compliance with the essential requirements and other relevant provisions of Directive 1999/5/EC.

Please contact the following address for the original Declaration of Conformity:

**CANON EUROPA N.V.**

Bovenkerkerweg 59, 1185 XB Amstelveen, The Netherlands

**CANON INC.**

30-2, Shimomaruko 3-chome, Ohta-ku, Tokyo 146-8501, Japan



# Acquiring GPS Signals

To acquire GPS signals, take the camera outside where the sky is unobstructed. Face the top of the camera toward the sky while keeping your hands, etc. away from the camera top.

When the signal acquisition conditions are good, it will take the camera approx. 30 sec. to 60 sec. to acquire the GPS satellite signals after you set [GPS] to [Mode 1] or [Mode 2]. Check that [GPS] is displayed on the LCD panel, then shoot.

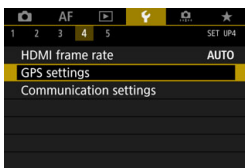

## 1 Select [GPS settings].

- Under the [**4**] tab, select [**GPS settings**], then press <SET>.

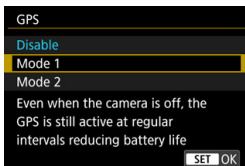

## 2 Select the mode.

- Select [**Mode 1**] or [**Mode 2**].
  - [**GPS**] will be displayed on the LCD panel.

### • Mode 1

The camera will continue to receive GPS signals at regular intervals even when the power switch is set to <**ON**> or <**OFF**>.

### • Mode 2

When the power switch is set to <**ON**>, the camera will receive GPS signals. When the power switch is set to <**OFF**>, the GPS function will also turn off. However, if auto power off is in effect, the camera will continue to receive GPS signals at regular intervals.

## GPS Acquisition Status



The GPS acquisition status is indicated by the [GPS] icon displayed on the camera's LCD panel.

**Constant [GPS]:** Signal acquired

**Blinking [GPS]:** Signal not acquired yet

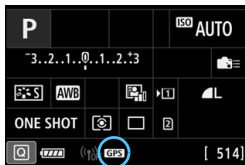

When you shoot while [GPS] is constantly displayed, the image will be geotagged.

- When [Mode 1] is set, the camera will continue to receive GPS signals at regular intervals even when the power switch is set to <OFF>. Therefore, the battery will drain faster and fewer shots can be taken. If you will not use the camera for a prolonged period, set to [Disable].
- When [Mode 2] is set, the camera will continue to receive GPS signals at regular intervals even during auto power off. Therefore, if auto power off is prolonged, the battery will drain faster and fewer shots can be taken. If you will not use the camera for a prolonged period, set the power switch to <OFF>.
- The built-in GPS antenna is located in front of the hot shoe on the right when viewed from the back of the camera (p.28). The GPS signal can be acquired while an external Speedlite is attached to the hot shoe, but the acquisition sensitivity will slightly decrease.
- GPS Receiver GP-E2 (sold separately) cannot be used.





### Poor GPS Coverage

Under the following conditions, the GPS satellite signal will not be properly acquired. As a result, the geotag information may not be recorded or inaccurate geotag information may be recorded.

- Indoors, underground, in tunnels or forests, between buildings, or in valleys.
- Near high-voltage power lines or mobile phones operating on the 1.5 GHz band.
- When the camera is left inside a bag, etc.
- When traveling a long distance.
- When traveling through different environments.
- Since GPS satellites move as time passes, satellite movement can interfere with geotagging and cause missing or inaccurate location information even in conditions other than the above. Additionally, the location information may also include a different location information with the route traveled even if the camera was used at just one location.



- The battery level may be low when you start using the camera due to the effect of the GPS function. If necessary, recharge the battery or prepare a charged, spare battery (sold separately).
- The camera can receive GPS signals even when shooting in the vertical orientation.

## Viewing GPS Information

- 1 **Check the [GPS] setting.**
  - Check that [GPS] is set to [Mode 1] or [Mode 2].
- 2 **Select [GPS information display].**
  - ▶ The GPS information will be displayed.

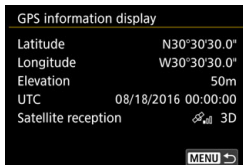
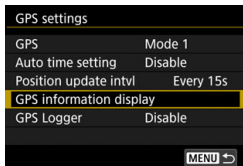

- 3 **Take the picture.**
  - When you shoot after GPS signal acquisition, the image will be geotagged.

Generally, elevation is not as accurate as latitude and longitude due to the nature of GPS.

- The icon indicates signal conditions. When <3D> is displayed, the elevation is also recorded. Note that the elevation cannot be recorded when <2D> is displayed.
- UTC (Coordinated Universal Time) is essentially the same as Greenwich Mean Time.

## Geotagging Information

Play back the images and press the **<INFO.>** button to display the shooting information screen (p.398). Then tilt **<GPS>** up or down to check the geotag information.



UTC (Coordinated Universal Time)



- When you shoot a movie, the GPS information at the time when shooting begins is recorded. Note that signal reception conditions are not recorded.
- Shooting locations can be viewed on a map displayed on a computer, using the Map Utility (EOS software, p.599).

# Setting the Positioning Interval

The interval (time) to update the geotag information can be set. Although updating the geotag information at shorter intervals will record more accurate location information, it will reduce the number of possible shots because it will drain the battery faster.

## 1 Check the [GPS] setting.

- Check that [GPS] is set to [Mode 1] or [Mode 2].

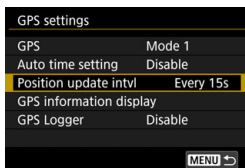

## 2 Select [Position update intvl].

## 3 Set the desired update interval.

- Select the desired update interval, then press <SET>.

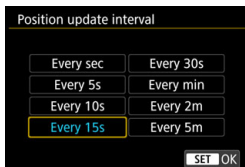

- If you are in a location where the GPS acquisition condition is not good, the number of possible shots will decrease.
- The nature of GPS may cause some inconsistency in update intervals.

# Setting Time from GPS on the Camera

The time information obtained from GPS signals can be set on the camera. The margin of error is approx.  $\pm 1$  sec.

- 1 Check the **[GPS]** setting.
  - Check that **[GPS]** is set to **[Mode 1]** or **[Mode 2]**.

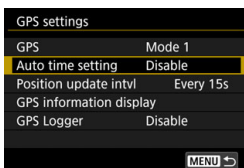

- 2 Select **[Auto time setting]**.

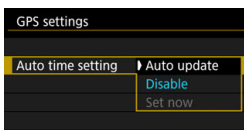

- 3 Select the desired setting.
  - Select **[Auto update]** or **[Set now]**, then press  $\langle \text{SET} \rangle$ .
  - **[Auto update]** updates the time when the camera's power switch is on and a GPS signal is received.

- ! If signals from at least five GPS satellites cannot be acquired, the time cannot be auto updated. **[Set now]** will be grayed out and not selectable.
- Even if **[Set now]** can be selected, updating the time may not be possible due to an unfavorable timing of the GPS signal acquisition.
- When **[Auto time setting]** is set to **[Auto update]**, the date or time cannot be manually set with **[ $\blacklozenge$  2: Date/Time/Zone]**.
- If you use Wireless File Transmitter WFT-E7 (Ver. 2/sold separately) and do not want to change the time after implementing **[Sync time between cameras]**, set **[Auto time setting]** to **[Disable]** in step 2.

# Logging the Route Traveled



Map data ©2016 ZENRIN

When using the GPS logging function, the geotag information of the route the camera travels is automatically recorded in the camera's internal memory.

With Map Utility (EOS software, p.599), you can view the shooting locations and the route traveled on a map displayed on a computer.

## 1 Check the [GPS] setting.

- Check that [GPS] is set to [Mode 1] or [Mode 2].

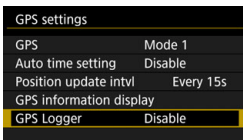

## 2 Select [GPS Logger].

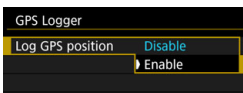

## 3 Set [Log GPS position] to [Enable].

- Select [Log GPS position], then press <SET>.
- Select [Enable], then press <SET>.
- ▶ [LOG] will be displayed on the LCD panel.

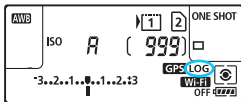

- With [GPS] set to [Mode 1], the GPS logging function will continue to work even while the power switch is set to <OFF>.
- When [Mode 2] is set, setting the power switch to <OFF> will also turn off the GPS logging function. However, the GPS logging function will continue to work during auto power off.

## Geotag Information Logs

Geotag information for the route the camera travels is recorded at the intervals set with **[Position update intvl]** (p.236). The log data is saved in the camera's internal memory by date. The table below shows how many days' worth of data can be saved.

### Log Data Capacity by Positioning Interval (Approx.)

Update Interval	Log Data	Update Interval	Log Data
Every 1 sec.	4.1 days	Every 30 sec.	100 days
Every 5 sec.	20 days	Every 1 min.	100 days
Every 10 sec.	41 days	Every 2 min.	100 days
Every 15 sec.	61 days	Every 5 min.	100 days

\* Based on 1 day equivalent to eight hours worth of log data.

- The log data saved in the internal memory can be transferred as a log file to a card (p.240).
- Log file names consist of the date and number (e.g. 16081800). A log file is created for each day. If the time zone changes (p.51), a new log file will be created.
- If the camera's internal memory becomes full, the oldest log data will be erased, and the newest log data will be saved.

## Battery Consumption During Logging

When **[GPS]** is set to **[Mode 1]**, the camera will continue to receive GPS signals at regular intervals even after the camera's power switch is set to **<OFF>**. If **[Mode 2]** is set, the camera will continue to receive GPS signals at regular intervals even during auto power off. The battery will thereby drain faster and the number of possible shots will decrease. Additionally, when **[Log GPS position]** is set to **[Enable]**, shorter update intervals will drain the battery more quickly.

When you are not traveling or when GPS signals are weak, setting **[GPS]** to **[Disable]** is recommended.

## Downloading Log Data to a Computer

The log data in the camera's internal memory can be downloaded to a computer with EOS Utility (EOS software, p.598) or downloaded from a card after transferring the data to the card.

When you use Map Utility (EOS software, p.599) to open a log file saved on the computer, the camera's travel route will be displayed on a map.

### ● Importing the log data using EOS software

With the camera connected to a computer via the provided interface cable, you can download the log data to the computer with EOS Utility (EOS software). For details, refer to the EOS Utility Instruction Manual (p.600).

### ● Transferring the log data to a card for downloading

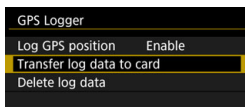

- When [Transfer log data to card] is selected, you can transfer the log data in the internal memory as log files to a CF card [1] or SD card [2]. Note that when log files are transferred to a card, that log data is erased from the camera's internal memory.



- The log files imported to the card will be stored in the "GPS" folder in the "MISC" folder. The extension is ".LOG".
- Selecting [Delete log data] will erase the log data saved in the internal memory. Erasing the data may take approx. one minute.





- When connecting the camera to a computer, use the provided interface cable or one from Canon (p.525). When connecting the interface cable, use the provided cable protector (p.38).
- The GPS antenna is located at the top of the camera body. For this reason, even when carrying the camera, such as in a bag, try to keep the top of the camera facing upwards, and do not place anything on top of it.
- Set the camera time and date as accurately as possible. Also, set correct time zone and daylight saving time for the shooting location.



# 6

## Advanced Operations for Photographic Effects

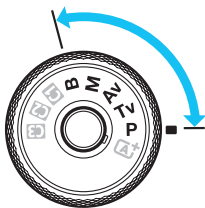

In the **<P>**, **<Tv>**, **<Av>**, **<M>**, and **<B>** modes, you can change various settings of the camera as you desire to obtain a wide variety of shooting results, by selecting the shutter speed and/or aperture, adjusting the exposure as you prefer, etc.

- A ☆ icon at the upper right of a page title indicates a function that can be used only in the following modes: **<P>** **<Tv>** **<Av>** **<M>** **<B>**.
- After you press the shutter button halfway and let go, the exposure settings will remain displayed in the viewfinder and on the LCD panel for approx. 4 sec. (⌚4) by the metering timer function.
- For the functions settable in each shooting mode, see page 536.



Set the **<LOCK▶>** switch to the left.

## P: Program AE

The camera automatically sets the shutter speed and aperture to suit the subject's brightness. This is called Program AE.

\* <P> stands for Program.

\* AE stands for Auto Exposure.



### 1 Set the Mode Dial to <P>.



### 2 Focus on the subject.

- Look through the viewfinder and aim the AF point over the subject. Then press the shutter button halfway.
- ▶ When focus is achieved, the focus indicator <●> in the viewfinder will light up (in One-Shot AF mode).
- ▶ The shutter speed and aperture will be set automatically and displayed in the viewfinder and on the LCD panel.



### 3 Check the display.

- The standard exposure will be obtained as long as the shutter speed and aperture displays do not blink.

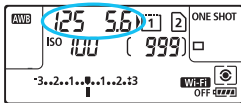

### 4 Take the picture.

- Compose the shot and press the shutter button completely.



- If the "30" shutter speed and the lowest f/number blink, it indicates underexposure. Increase the ISO speed or use flash.



- If the "8000" shutter speed and the highest f/number blink, it indicates overexposure. Lower the ISO speed or use an ND filter (sold separately) to reduce the amount of light entering the lens.



### Differences Between <P> and <A+> Modes

In the <A+> mode, many functions, such as the AF operation and metering mode, are set automatically to prevent spoiled shots. The functions you can set are limited. With <P> mode, only the shutter speed and aperture are set automatically. You can freely set the AF operation, metering mode, and other functions (p.536).

### Program Shift

- In the Program AE mode, you can freely change the shutter speed and aperture combination (Program) set automatically by the camera while maintaining the same exposure. This is called Program shift.
- To shift the program, press the shutter button halfway, then turn the <mode> dial until the desired shutter speed or aperture is displayed.
- Program shift will be canceled automatically when the metering timer (4) ends (exposure setting display turns off).
- Program shift cannot be used with flash.

## Tv: Shutter-Priority AE

In this mode, you set the shutter speed and the camera automatically sets the aperture to obtain the standard exposure matching the brightness of the subject. This is called shutter-priority AE. A faster shutter speed can freeze the action of a moving subject. A slower shutter speed can create a blurred effect, giving the impression of motion.

\* <Tv> stands for Time value.

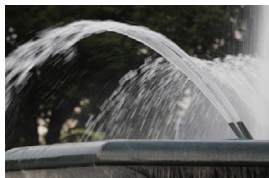

Blurred motion  
(Slow shutter speed: 1/30 sec.)



Frozen motion  
(Fast shutter speed: 1/2000 sec.)



1 Set the Mode Dial to <Tv>.

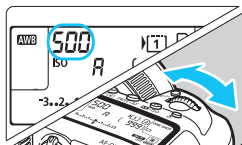

2 Set the desired shutter speed.

- While looking at the LCD panel or in the viewfinder, turn the <⚙> dial.

3 Focus on the subject.

- Press the shutter button halfway.
- ▶ The aperture is set automatically.

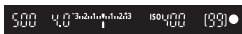

4 Check the viewfinder display and shoot.

- As long as the aperture is not blinking, the standard exposure will be obtained.



- If the lowest f/number blinks, it indicates underexposure. Turn the <math>\langle \text{aperture} \rangle</math> dial to set a slower shutter speed until the aperture stops blinking or set a higher ISO speed.



- If the highest f/number blinks, it indicates overexposure. Turn the <math>\langle \text{aperture} \rangle</math> dial to set a faster shutter speed until the aperture stops blinking or set a lower ISO speed.



### Shutter Speed Display

The shutter speeds from “8000” to “4” indicate the denominator of the fractional shutter speed. For example, “125” indicates 1/125 sec. , “0.5” indicates 0.5 sec. and “15” is 15 sec.

## Av : Aperture-Priority AE

In this mode, you set the desired aperture and the camera sets the shutter speed automatically to obtain the standard exposure matching the subject brightness. This is called aperture-priority AE. A higher f/number (smaller aperture hole) will make more of the foreground and background fall within acceptable focus. On the other hand, a lower f/number (larger aperture hole) will make less of the foreground and background fall within acceptable focus.

\* <Av> stands for Aperture value (aperture opening).

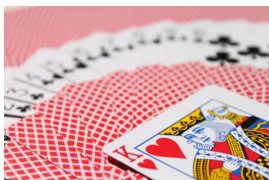

Blurred background  
(With a low aperture f/number: f/5.6)



Sharp foreground and background  
(With a high aperture f/number: f/32)



1 Set the Mode Dial to <Av>.

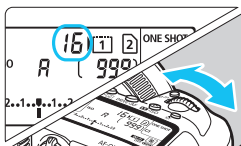

2 Set the desired aperture.

- While looking at the LCD panel or in the viewfinder, turn the <  > dial.

3 Focus on the subject.

- Press the shutter button halfway.
- ▶ The shutter speed is set automatically.



4 Check the viewfinder display and shoot.

- As long as the shutter speed is not blinking, the standard exposure will be obtained.





- If the “30” shutter speed blinks, it indicates underexposure. Turn the <img alt="Aperture dial icon" data-bbox="465 148 505 165"/> dial to set a larger aperture (lower f/number) until the shutter speed blinking stops or set a higher ISO speed.



- If the “8000” shutter speed blinks, it indicates overexposure. Turn the <img alt="Aperture dial icon" data-bbox="465 270 505 287"/> dial to set a smaller aperture (higher f/number) until the shutter speed blinking stops or set a lower ISO speed.



### Aperture Value Display

The higher the f/number, the smaller the aperture opening will be. The f/number displayed will differ depending on the lens. If no lens is attached to the camera, “00” will be displayed for the aperture.

## Depth-of-Field Preview <sup>☆</sup>

The aperture opening (diaphragm) changes only at the moment when the picture is taken. Otherwise, the aperture remains fully open. Therefore, when you look at the scene through the viewfinder or on the LCD monitor, the depth of field will look narrow.

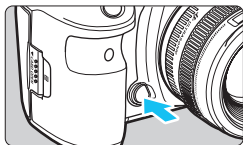

Press the depth-of-field preview button to stop down the lens to the current aperture setting and check the depth of field (range of acceptable focus).

- A higher f/number will make more of the foreground and background fall within acceptable focus. However, the viewfinder will look darker.
- The depth-of-field effect can be clearly seen on the Live View image as you change the aperture and press the depth-of-field preview button (p.298).
- The exposure will be locked (AE lock) while the depth-of-field preview button is being pressed.

# M: Manual Exposure

In this mode, you set both the shutter speed and aperture as desired. To determine the exposure, refer to the exposure level indicator in the viewfinder or use a commercially-available exposure meter. This method is called manual exposure.

\* <M> stands for Manual.



1 Set the Mode Dial to <M>.

2 Set the ISO speed (p.177).

3 Set the shutter speed and aperture.

- To set the shutter speed, turn the <☀> dial. To set the aperture, turn the <☉> dial.
- If it cannot be set, set the <LOCK▶> switch to the left, then turn the <☀> or <☉> dial.

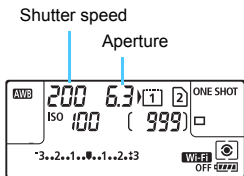

Standard exposure index



Exposure level mark

4 Focus on the subject.

- Press the shutter button halfway.
  - ▶ The exposure setting will be displayed in the viewfinder and on the LCD panel.
- Check the exposure level mark <|> to see how far the current exposure level is from the standard exposure level.

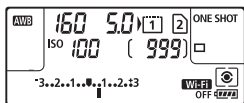

5 Set the exposure and take the picture.

- Check the exposure level indicator and set the desired shutter speed and aperture.
- If the exposure level exceeds  $\pm 3$  stops from the standard exposure, the end of the exposure level indicator will display <◀> or <▶>.

## Exposure Compensation with ISO Auto

If the ISO speed is set to **A** (AUTO) for **<M>** manual exposure shooting, you can set exposure compensation (p.255) as follows:

- [ 2: Expo.comp./AEB]
- Under [ 3: Custom Controls], with [ 3: Expo comp (hold btn, turn sun)] or [ 3: Expo comp (hold btn, turn sun)] (p.506).
- Quick Control (p.64)

- If ISO Auto is set, the ISO speed setting will change to obtain the standard exposure with the set shutter speed and aperture. Therefore, you may not obtain the desired exposure effect. In such a case, set the exposure compensation.
- If flash is used when ISO Auto is set, exposure compensation will not be applied even if an exposure compensation amount is set.

- Under [ 2: Auto Lighting Optimizer], if the checkmark [✓] for [Disabled in M or B modes] is removed, Auto Lighting Optimizer can be set even in the **<M>** mode (p.201).
- When ISO Auto is set, you can press the **<★>** button to lock the ISO speed.
- If you press the **<★>** button and recompose the shot, you can see the exposure level difference on the exposure level indicator compared with when the **<★>** button was pressed.
- If exposure compensation (p.255) was applied in **<P>**, **<Tv>**, or **<Av>** mode, and then the shooting mode is switched to **<M>** with ISO Auto set, the exposure compensation amount already set will still be maintained.
- With ISO Auto set and [ 1: Exposure level increments] set to [1/2-stop], any 1/2-stop exposure compensation will be implemented with the ISO speed (1/3 stop) and shutter speed. However, the shutter speed displayed will not change.

## Selecting the Metering Mode ☆



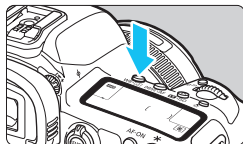

You can select one of four methods to measure the subject brightness. In the **<A+>** mode, evaluative metering is set automatically.

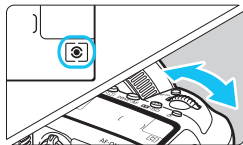

**1** Press the **<WB>** button (ⓘ6).



**2** Select the metering mode.

- While looking at the LCD panel or in the viewfinder, turn the **<WB>** dial.
  -  **Evaluative metering**
  -  **Partial metering**
  -  **Spot metering**
  -  **Center-weighted average metering**

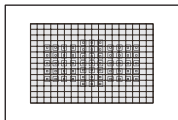

 **Evaluative metering**

General-purpose metering mode suited even for backlit subjects. The camera adjusts the exposure automatically to suit the scene.

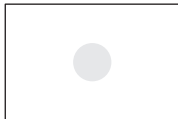

 **Partial metering**

Effective where there are much brighter lights around the subject due to backlight, etc. Partial metering covers approx. 6.1% of the viewfinder area at the center.

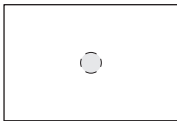





: **Spot metering**

Effective when metering a specific part of the subject or scene. Spot metering covers approx. 1.3% of the viewfinder area at the center. The spot metering circle will be displayed in the viewfinder.



: **Center-weighted average metering**

The metering is averaged for the entire scene with the viewfinder center weighted more heavily.

 With  (Evaluative metering), the exposure setting will be locked when you press the shutter button halfway and focus is achieved (in One-Shot AF mode). In the ,  (Spot metering), and  (Center-weighted average metering) modes, the exposure is set at the moment the picture is taken. (Pressing the shutter button halfway does not lock the exposure.)



## Setting the Desired Exposure Compensation <sup>☆</sup>

Exposure compensation can brighten (increased exposure) or darken (decreased exposure) the standard exposure set by the camera. Exposure compensation can be set in the <P>, <Tv>, and <Av> shooting modes. Although you can set the exposure compensation up to  $\pm 5$  stops in 1/3-stop increments for viewfinder shooting, the exposure compensation indicator in the viewfinder and on the LCD panel can display the setting only up to  $\pm 3$  stops. If you want to set the exposure compensation setting beyond  $\pm 3$  stops, use the Quick Control (p.64) or follow the instructions for [ 2: Expo.comp./AEB] on page 257. If the <M> mode and ISO Auto are both set, see page 252 to set the exposure compensation.

### 1 Check the exposure.

- Press the shutter button halfway () and check the exposure level indicator.

### 2 Set the exposure compensation amount.

- While looking at the viewfinder or LCD panel, turn the < > dial.
- If it cannot be set, set the <LOCK▶> switch to the left, then turn the < > dial.
- ▶ For exposure compensation, the < > icon will be displayed in the viewfinder and on the LCD panel.





Increased exposure for a brighter image



Decreased exposure for a darker image



### 3 Take the picture.

- To cancel exposure compensation, set the exposure level indicator < /  > to the standard exposure index (< > / < >).

## ☑ Setting the Desired Exposure Compensation \*

- For Live View and movie shooting, the exposure compensation can be set only up to  $\pm 3$  stops.
  - If [**2: Auto Lighting Optimizer**] (p.201) is set to any setting other than [**Disable**], the image may still look bright even if a decreased exposure compensation for a darker image is set.
- 
- The exposure compensation amount will remain in effect even after you set the power switch to **<OFF>**.
  - After setting the exposure compensation amount, you can set the **<LOCK▶>** switch to the right to prevent the exposure compensation amount from changing inadvertently.
  - If the exposure compensation amount exceeds  $\pm 3$  stops, the end of the exposure level indicator will display **<◀>** or **<▶>**.



# Auto Exposure Bracketing (AEB) ☆

By changing the shutter speed or aperture automatically, the camera brackets the exposure up to  $\pm 3$  stops in 1/3-stop increments for three consecutive shots. This is called AEB.

\* AEB stands for Auto Exposure Bracketing.

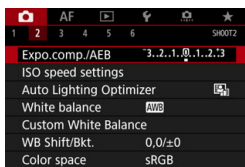

## 1 Select [Expo.comp./AEB].

- Under the [CAMERA] tab, select [Expo.comp./AEB], then press <SET>.

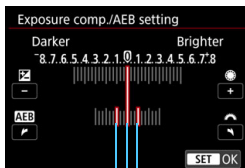

AEB range

## 2 Set the AEB range.

- Turn the <DIAL> dial to set the AEB range. If you turn <DIAL>, you can set the exposure compensation amount.
- Press <SET> to set it.
- When you exit the menu, the AEB range will be displayed on the LCD panel.



## 3 Take the picture.

- Three bracketed shots will be taken according to the drive mode set in this sequence: Standard exposure, decreased exposure, and increased exposure.
- AEB will not be automatically canceled. To cancel AEB, follow step 2 to turn off the AEB range display.

Standard exposure



Decreased exposure



Increased exposure



-  ● During AEB shooting, <✳> will blink in the viewfinder.
- If the drive mode is set to <□> or <□S>, press the shutter button three times for each shot. When <□H>, <□>, or <□S> is set and you hold down the shutter button completely, the three bracketed shots will be taken consecutively and the camera will automatically stop shooting. When <☺> or <☺<sub>2</sub>> is set, the three bracketed shots will be taken consecutively after a 10-sec. or 2-sec. delay.
- You can set AEB in combination with exposure compensation.
- If the AEB range exceeds ±3 stops, the end of the exposure level indicator will display <◀> or <▶>.
- AEB cannot be used with flash, bulb exposures, or when Multi Shot Noise Reduction or HDR Mode is set.
- AEB will be canceled automatically when you set the power switch to <OFF> or when the flash is fully charged.

## ✳ Lock the Exposure for Shooting (AE Lock) ☆

You can lock the exposure when the area of focus is to be different from the exposure metering area or when you want to take multiple shots at the same exposure setting. Press the <✳> button to lock the exposure, then recompose and take the picture. This is called AE lock. It is effective for shooting backlit subjects, etc.

### 1 Focus on the subject.

- Press the shutter button halfway.
- ▶ The exposure setting will be displayed.

### 2 Press the <✳> button (ⓘ4).

- ▶ The <✳> icon lights up in the viewfinder to indicate that the exposure setting is locked (AE lock).
- Each time you press the <✳> button, the current exposure setting is locked.





### 3 Recompose and take the picture.

- If you want to take more pictures while maintaining the AE lock, keep holding down the <✳> button and press the shutter button to take another picture.



## AE Lock Effects

Metering Mode (p.253)	AF Point Selection Method (p.106, 107)	
	Automatic Selection	Manual Selection
 *	AE lock is applied at the AF point that achieved focus.	AE lock is applied at the selected AF point.
	AE lock is applied at the center AF point.	

\* When the lens's focus mode switch is set to <MF>, AE lock is implemented with the exposure weighting centered on the center AF point.

 AE lock is not possible with bulb exposures.

## B: Long (Bulb) Exposures

In this mode, the shutter stays open as long as you hold down the shutter button completely, and closes when you let go of the shutter button. This photographic technique is called “bulb exposure”. Use bulb exposures for night scenes, fireworks, the heavens, and other subjects requiring long exposures.



### 1 Set the Mode Dial to <B>.

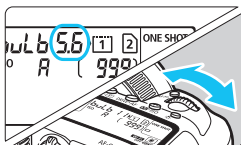

### 2 Set the desired aperture.

- While looking at the LCD panel or the viewfinder, turn the <☀> or <⚙> dial.



Elapsed exposure time

### 3 Take the picture.

- The exposure will continue for as long as you keep the shutter button pressed completely.
- ▶ The elapsed exposure time will be displayed on the LCD panel.

- Do not point the camera toward an intense light source, such as the sun or an intense artificial light source. Doing so may damage the image sensor or the camera's internal components.
- Long exposures produce more noise than usual.
- If ISO Auto is set, the ISO speed will be ISO 400 (p.179).
- For a bulb exposure, if you use both the self-timer and mirror lockup instead of the bulb timer, keep pressing the shutter button completely (self-timer delay time + bulb exposure time). If you let go of the shutter button during the self-timer countdown, there will be a shutter-release sound, but no picture will be taken. If you use the bulb timer under the same shooting conditions, you need not keep holding down the shutter button completely.



- With [**3**: Long exp. noise reduction], you can reduce the noise generated during long exposures (p.204).
- For bulb exposures, using a tripod and bulb timer is recommended. You can also use mirror lockup (p.276) in combination.
- You can also shoot bulb exposures by using Remote Switch RS-80N3 or Timer Remote Controller TC-80N3 (each sold separately, p.279).
- You can also use Remote Controller RC-6 (sold separately, p.279) for bulb exposures. When you press the remote controller's transmit button, the bulb exposure will start immediately or 2 sec. later. Press the button again to stop the bulb exposure.

## TIMER Bulb Timer ☆

You can preset the bulb exposure's exposure time. With the bulb timer, you need not keep holding down the shutter button during the bulb exposure. This reduces camera shake.

The bulb timer can be set only in the <**B**> (Bulb) shooting mode. It cannot be set (or will not function) in any other shooting mode.

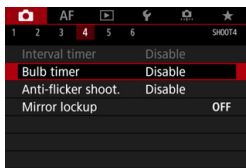

### 1 Select [Bulb timer].

- Under the [**4**] tab, select [**Bulb timer**], then press <SET>.

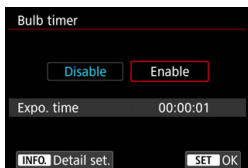

### 2 Select [Enable].

- Select [**Enable**], then press the <INFO.> button.

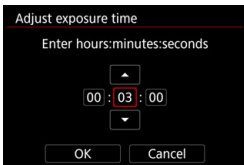

### 3 Set the desired exposure time.

- Select the hour, minute, or second.
- Press <SET> so <⏱> is displayed.
- Set the desired number, then press <SET> (Returns to <□>).

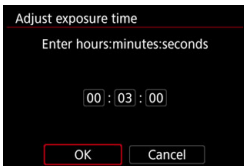

### 4 Select [OK].

- ▶ The set time will be displayed on the menu screen.
- ▶ When you exit the menu, <TIMER> will be displayed on the LCD panel.



### 5 Take the picture.

- ▶ Press the shutter button completely, and the bulb exposure will start and continue until the set time elapses.
- During bulb timer shooting, <TIMER> will blink.
- To cancel the timer setting, set [Disable] in step 2.

Elapsed exposure time  
Bulb timer

- While the bulb timer is operating, if you press the shutter button completely and release it, the bulb exposure will stop.
- If you keep pressing the shutter button completely after the exposure starts, the bulb exposure will continue even after the set exposure time elapses. (The bulb exposure will not stop automatically when the set exposure time elapses.)
- Doing any of the following will cancel the bulb timer (reverts to [Disable]): Set the power switch to <OFF>, replace the battery, replace the card, switch to movie shooting, or change the shooting mode to other than <B>.

# HDR : HDR (High Dynamic Range) Shooting ☆

You can shoot still photos with clipped highlights and shadows reduced for a high dynamic range of tones even in high-contrast scenes. HDR shooting is effective for landscape and still-life shots.

**With HDR shooting, three images of different exposures (standard exposure, underexposure, and overexposure) are captured consecutively for each shot and then merged together automatically. The HDR image is recorded as a JPEG image.**

\* HDR stands for High Dynamic Range.



**1 Press the <[HDR]> button.**

**2 Select the HDR mode.**

- Select [HDR], then press <[SET]>.
- ▶ The HDR mode screen will appear.

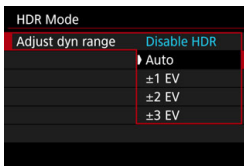

**3 Set [Adjust dyn range].**

- Select the desired dynamic range setting, then press <[SET]>.
- Selecting [Auto] will have the dynamic range set automatically depending on the image's overall tonal range.
- The higher the number, the wider the dynamic range will be.
- To exit HDR shooting, select [Disable HDR].

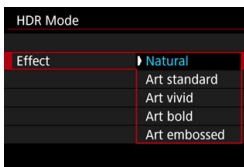

**4 Set [Effect].**

- Select the desired effect, then press <[SET]>.



● You can also set HDR shooting with [CAMERA: HDR Mode].

## Effects

- **Natural**

For images preserving a wide tonal range where the highlight and shadow details would otherwise be lost. Clipped highlights and shadows will be reduced.

- **Art standard**

While the clipped highlights and shadows will be reduced more than with **[Natural]**, the contrast will be lower, and the gradation flatter to have the picture look like a painting. The subject outlines will have bright (or dark) edges.

- **Art vivid**

The colors are more saturated than with **[Art standard]**, and the low contrast and flat gradation create a graphic art effect.

- **Art bold**

The colors are the most saturated, making the subject pop out, and the picture looks like an oil painting.

- **Art embossed**

The color saturation, brightness, contrast and gradation are decreased to make the picture look flat. The picture looks faded and old. The subject outlines will have bright (or dark) edges.

	<b>Art standard</b>	<b>Art vivid</b>	<b>Art bold</b>	<b>Art embossed</b>
<b>Saturation</b>	Standard	High	Higher	Low
<b>Outline emphasis</b>	Standard	Weak	Strong	Stronger
<b>Brightness</b>	Standard	Standard	Standard	Dark
<b>Tone</b>	Flat	Flat	Flat	Flatter

 Each effect will be applied based on the characteristics of the Picture Style currently set (p.183).



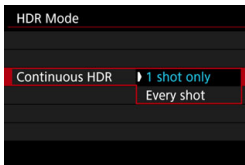

## 5 Set [Continuous HDR].

- Select either [**1 shot only**] or [**Every shot**], then press <ⓈET>.
- With [**1 shot only**], HDR shooting will be canceled automatically after the shooting ends.
- With [**Every shot**], HDR shooting continues until the setting in step 3 is set to [**Disable HDR**].

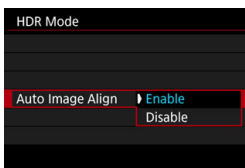

## 6 Set [Auto Image Align].

- For handheld shooting, select [**Enable**]. When using a tripod, select [**Disable**], then press <ⓈET>.

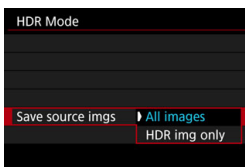

## 7 Set the images to be saved.

- To save all three images and the merged HDR image, select [**All images**], then press <ⓈET>.
- To save only the HDR image, select [**HDR img only**], then press <ⓈET>.

## 8 Take the picture.

- HDR shooting is possible with viewfinder shooting and Live View shooting.
- When you press the shutter button completely, three consecutive images will be captured, and the HDR image will be recorded to the card.

- If the image-recording quality is set to RAW, the HDR image will be recorded in **L** quality. If the image-recording quality is set to RAW+JPEG, the HDR image will be recorded in the JPEG quality set.
- HDR shooting is not possible with expanded ISO speeds (L, H1, H2). HDR shooting is possible within ISO 100 - ISO 32000 (varies depending on the settings of **[Minimum]** and **[Maximum]** under **[Range for stills]**).
- The flash will not fire during HDR shooting.
- HDR shooting will automatically have the following set to **[Disable]**: **[Distortion correction]** under **[1: Lens aberration correction]**, **[2: Auto Lighting Optimizer]**, and **[3: Highlight tone priority]**.
- AEB cannot be set.
- If you shoot a moving subject, the moving subject may leave afterimages.
- In HDR shooting, 3 images are captured with different shutter speeds set automatically. Therefore, even in the **<Tv>** and **<M>** shooting modes, the shutter speed will be shifted based on the shutter speed you set.
- To prevent camera shake, a high ISO speed may be set.
- You can set the camera to display **<H>** in the viewfinder and on the LCD panel for when the HDR mode is set (p.489).



- When shooting HDR images with [**Auto Image Align**] set to [**Enable**], AF point display information (p.402) and Dust Delete Data (p.460) will not be appended to the image.
- If you perform handheld HDR shooting with [**Auto Image Align**] set to [**Enable**], image periphery will be slightly trimmed and resolution will be slightly lowered. Also, if the images cannot be aligned properly due to camera shake, etc., auto image alignment may not take effect. Note that when shooting with excessively bright (or dark) exposure settings, auto image alignment may not work properly.
- If you perform handheld HDR shooting with [**Auto Image Align**] set to [**Disable**], the 3 images may not be properly aligned and the HDR effect may become smaller. Using a tripod is recommended.
- Auto image alignment may not work properly with repetitive patterns (lattice, stripes, etc.) or flat, single-tone images.
- The color gradation of the sky or white walls may not be reproduced correctly. Irregular colors, irregular exposure or noise may appear.
- HDR shooting under fluorescent or LED lighting may result in unnatural color reproduction of the illuminated areas.
- With HDR shooting, the images will be merged, then saved to the card, so it may take some time. Therefore, it will take a longer time to record the HDR image to the card than with normal shooting. During the processing of the images, “**buSY**” will be displayed in the viewfinder and on the LCD panel, and you cannot take another picture until the processing is completed.
- If you set HDR shooting and then switch to movie shooting, the HDR shooting setting may be canceled (the [**Adjust dyn range**] setting may be changed to [**Disable HDR**]).

## Multiple Exposures ☆

You can shoot two to nine exposures to be merged into one image. With Live View shooting (p.297), you can see in real time how the exposures are merged when you shoot multiple-exposure images.

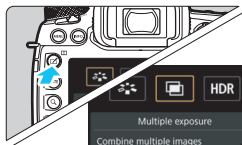

1 Press the  button.

2 Select **Multiple exposure**.

- Select [, then press <SET>.
- ▶ The multiple exposure setting screen will appear.

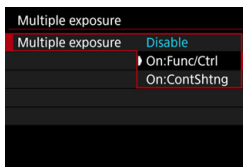

3 Set [**Multiple exposure**].

- Select [**On:Func/Ctrl**] or [**On:ContShtng**], then press <SET>.
- To exit shooting multiple exposures, select [**Disable**].

- **On: Func/Ctrl (Function and control priority)**

Useful when you want to shoot multiple exposures while checking the result as you proceed. During continuous shooting, the continuous shooting speed will decrease greatly.

- **On: ContShtng (Continuous shooting priority)**

Geared for continuous multiple-exposure shooting of a moving subject. Continuous shooting is possible, but the following operations are disabled during shooting: menu viewing, image review after image capture, image playback, and undo last image (p.274). Also, during Live View shooting, the image displayed will not be the final merged image.

Note that only the multiple-exposure image will be saved. (The single exposures merged in the multiple-exposure image will not be saved.)

 You can also set multiple exposure with [**3: Multiple exposure**].

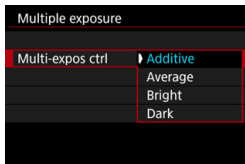

## 4 Set [Multi-expos ctrl].

- Select the desired multiple-exposure control method, then press <SET>.

### • Additive

The exposure of each single image captured is added cumulatively. Based on the [No. of exposures], set a negative exposure compensation. Follow the basic guide below to set the exposure compensation amount.

#### Exposure Compensation Setting Guide by Number of Exposures

Two exposures: -1 stop, three exposures: -1.5 stop, four exposures: -2 stops

### • Average

Based on the [No. of exposures], negative exposure compensation is set automatically as you shoot multiple exposures. If you shoot multiple exposures of the same scene, the exposure of the subject's background will be automatically controlled to obtain the standard exposure.

### • Bright/Dark

The brightness (or darkness) of the base image and the images to be added are compared at the same position, and then the bright (or dark) part will be left in the picture. Depending on the overlapping colors, the colors may be mixed depending on the brightness (or darkness) ratio between the compared images.



## 5 Set the [No. of exposures].

- Select the number of exposures, then press <SET>.
- You can set it from 2 to 9 exposures.

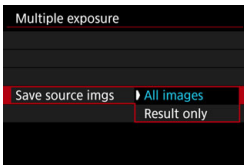

## 6 Set the images to be saved.

- To save all the single exposures and the merged multiple-exposure image, select [**All images**], then press <SET>.
- To save only the merged multiple-exposure image, select [**Result only**], then press <SET>.



## 7 Set [Continue Mult-exp].

- Select either [**1 shot only**] or [**Continuously**], then press <SET>.
- With [**1 shot only**], multiple-exposure shooting will be canceled automatically after the shooting ends.
- With [**Continuously**], multiple-exposure shooting continues until the setting in step 3 is set to [**Disable**].



Remaining number of exposures

## 8 Shoot the first exposure.

- ▶ When [**On:Func/Ctrl**] is set, the captured image will be displayed.
- ▶ The <[ ]> icon will blink.
- You can check the remaining exposures in brackets [ ] displayed in the viewfinder or on the screen.
- Pressing the <[ ]> button enables you to view the captured image (p.274).

## 9 Shoot subsequent exposures.

- ▶ When [**On:Func/Ctrl**] is set, the merged multiple-exposure image will be displayed.
- Live View shooting with [**On:Func/Ctrl**] set, the multiple-exposure images merged so far will be displayed. By pressing the <**INFO.**> button, you can display only the Live View image.
- Multiple-exposure shooting will end when the set number of exposures are taken. With continuous shooting, if you keep holding down the shutter button, the shooting will stop (or pause) after the set numbers of exposures are taken.



- When [**On:Func/Ctrl**] is set, you can press the <> button to view the multiple exposures taken so far or delete the last single exposure (p.274).
- The shooting information for the last shot will be recorded and appended to the multiple-exposure image.

- The image-recording quality, ISO speed, Picture Style, high ISO speed noise reduction, color space, etc. set for the first single exposure will also be set for the subsequent exposures.
- During multiple-exposure shooting, the settings will be automatically switched to **[Disable]** for the following: all the items of **[Q1: Lens aberration correction]**, **[Q2: Auto Lighting Optimizer]**, and **[Q3: Highlight tone priority]**.
- If **[Q3: Picture Style]** is set to **[Auto]**, **[Standard]** will be applied for shooting.
- With **[On:Func/Ctrl]** and **[Additive]** set, the noise, irregular colors, banding, etc. of the image displayed during shooting may differ from the multiple-exposure image recorded in the end.
- With multiple exposures, the more exposures there are, the more noticeable the noise, irregular colors, and banding will be.
- If **[Additive]** is set, the image processing after taking the multiple exposures will take time. (The access lamp will light up longer.)
- If you perform Live View shooting with **[Additive]** set, the Live View function will stop automatically when the multiple-exposure shooting ends.
- In step 9, the brightness and noise of the multiple-exposure image displayed during Live View shooting will be different from those of the final multiple-exposure image recorded.
- If **[On:ContShtn]** is set, let go of the shutter button after shooting the set number of exposures.
- Doing any of the following will cancel the multiple-exposure shooting: Setting the power switch to **<OFF>**, replacing the battery, replacing the card, or switching to movie shooting.
- During multiple-exposure shooting, **[Clean now **] or **[Clean manually]** under **[F3: Sensor cleaning]** cannot be selected.
- If you switch the shooting mode to **<A+>** or **<C1>**, **<C2>**, or **<C3>** during shooting, multiple-exposure shooting will end.
- If you connect the camera to a computer, multiple-exposure shooting will not be possible. If you connect the camera to a computer during shooting, multiple-exposure shooting will end.



## Merging Multiple Exposures with an Image Recorded on the Card

You can select a **RAW** image recorded on the card as the first single exposure. The image data of the selected **RAW** image will remain intact.

**You can only select RAW images.** You cannot select **M RAW/S RAW** or JPEG images.

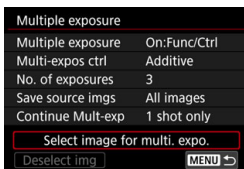

### 1 Select [Select image for multi. expo.].

- ▶ The images on the card will be displayed.

### 2 Select the first image.

- Turn the < > dial to select the image to be used as the first single exposure, then press < >.

- Select [OK].
- ▶ The file number of the selected image will be displayed at the bottom of the screen.

### 3 Take the picture.

- When you select the first image, the number of remaining exposures as set with [No. of exposures] will decrease by 1. For example, if [No. of exposures] is 3, you can shoot two exposures.



- The following cannot be selected as the first single exposure: Images shot with [ 3: Highlight tone priority] set to [Enable], images whose [ 5: Aspect ratio] is set to any setting other than [3:2] (p.310), or images having cropping information (p.491).
- [Disable] will be applied for [ 1: Lens aberration correction] and [ 2: Auto Lighting Optimizer] regardless of the settings of the **RAW** image selected as the first single exposure.
- The ISO speed, Picture Style, high ISO speed noise reduction, color space, etc. set for the first **RAW** image will also be applied for the subsequent images.
- If Picture Style is [Auto] for the **RAW** image selected as the first **RAW** image, [Standard] will be applied for shooting.
- You cannot select an image taken with another camera.

- You can also select a **RAW** multiple-exposure image as the first single exposure.
- If you select [**Deselect img**], the image selection will be canceled.

## Checking and Deleting Multiple Exposures During Shooting

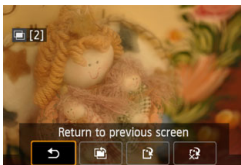

When [**On:Func/Ctrl**] is set and you have not finished shooting the set number of exposures, you can press the <[▶]> button to check the current exposure level, overlap alignment, and overall effect of the merged multiple-exposure image. (Not possible when [**On:ContShtng**] is set.)

If you press the <[⏏]> button, the operations possible during multiple-exposure shooting will be displayed.

Operation	Description
<b>Undo last image</b>	Deletes the last image you shot (shoot another image). The number of remaining exposures will increase by 1.
<b>Save and exit</b>	If [ <b>Save source imgs: All images</b> ] is set, all of the single exposures and the merged multiple-exposure image will be saved before exiting. If [ <b>Save source imgs: Result only</b> ] is set, only the multiple-exposure image merged so far will be saved before exiting.
<b>Exit without saving</b>	Multiple-exposure shooting will end without saving the images shot.
<b>Return to previous screen</b>	The screen before you pressed the <[⏏]> button will reappear.

- During multiple-exposure shooting, you can only play back multiple-exposure images.

## ? FAQ

### • Are there any restrictions on the image-recording quality?

All JPEG image-recording quality settings can be selected. If **M RAW** or **S RAW** is set, the merged multiple-exposure image will be saved as a **RAW** image.

Image Quality Setting	Single Exposures	Merged Multiple-Exposure
JPEG	JPEG	JPEG
RAW	RAW	RAW
M RAW / S RAW	M RAW / S RAW	RAW
RAW+JPEG	RAW+JPEG	RAW+JPEG
M RAW / S RAW+JPEG	M RAW / S RAW+JPEG	RAW+JPEG

### • Can I merge images recorded on the card?

With [Select image for multi. expo.], you can select the first single exposure from the images recorded on the card (p.273). Note that you cannot merge multiple images already recorded on the card.

### • Are multiple exposures possible with Live View shooting?

You can shoot multiple exposures with Live View shooting (p.297). However, if [On:ContShng] is set, the captured images will not be displayed as a multiple exposure.

### • What file numbers are used for saving merged multiple-exposures?

If it is set to save all images, the merged multiple-exposure image file number will be the serial number coming after the file number of the final single exposure used to create the merged multiple-exposure image.

### • Will auto power off take effect during multiple-exposure shooting?



As long as [⚡2: Auto power off] is set to any setting other than [Disable], the power will turn off automatically after approx. 30 min. If the auto power off takes effect, multiple-exposure shooting will end, and multiple-exposure settings will be canceled.

Before starting the multiple-exposure shooting, the auto power off will take effect at the time as set with the camera, and multiple-exposure settings will be canceled.

## Mirror Lockup <sup>☆</sup>

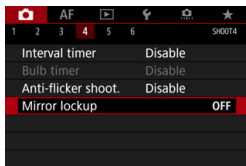
Camera vibrations caused by the mirror's reflex action when the picture is taken is called "mirror shock". Mirror lockup keeps the mirror up before and during exposure to reduce blur caused by camera vibrations. Useful when shooting close-ups (macro photography), using a super telephoto lens, shooting at slow shutter speeds, etc.



- 1 **Select [Mirror lockup].**
  - Under the [4] tab, select [**Mirror lockup**], then press </>.

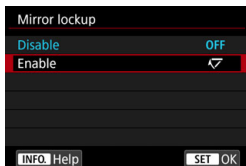

- 2 **Select [Enable].**

- 3 **Focus on the subject, then press the shutter button completely.**

▶ The mirror will swing up.

- 4 **Press the shutter button completely again.**

• The picture is taken and the mirror goes back down.



- Do not point the camera toward an intense light source, such as the sun or an intense artificial light source. Doing so may damage the image sensor or the camera's internal components.
- When shooting with mirror lockup in very bright light, such as at the beach or a ski slope on a sunny day, take the picture promptly after mirror lockup is stabilized.
- During mirror lockup, shooting function settings and menu operations are disabled.



- When [**Enable**] is set, single shooting will take effect even if the drive mode is set to continuous.
- You can also use the self-timer with mirror lockup.
- If approx. 30 sec. elapse after the mirror has locked up, it will go back down automatically. Pressing the shutter button completely locks up the mirror again.
- When shooting with mirror lockup, using a tripod and Remote Switch RS-80N3 or Timer Remote Controller TC-80N3 (each sold separately) is recommended (p.279).
- You can also use a remote controller (sold separately, p.279) with mirror lockup. Setting the remote controller to a 2-sec. delay is recommended.

## Using the Eyepiece Cover

When you take a picture without looking through the viewfinder, such as when you use the self-timer, bulb exposure, or a remote switch, stray light entering the viewfinder may cause the picture to look dark (underexposed). To prevent this, use the eyepiece cover (p.37) attached to the camera strap.

Note that attaching the eyepiece cover is not necessary in Live View shooting or movie shooting.

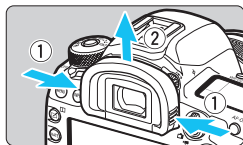

### 1 Detach the eyecup.

- While grasping both sides of the eyecup, slide it upward to detach it.

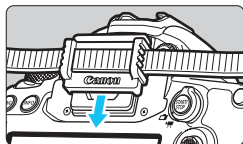

### 2 Attach the eyepiece cover.

- Slide the eyepiece cover down into the eyepiece groove to attach it.
- After you finish shooting, detach the eyepiece cover and attach the eyecup.

## Using a Remote Switch

You can connect any EOS accessory equipped with an N3-type terminal such as the Remote Switch RS-80N3 or Timer Remote Controller TC-80N3 (each sold separately) to shoot with the camera (p.525). To operate the accessory, refer to its Instruction Manual.

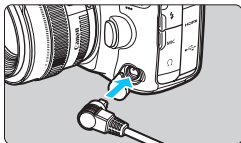

- 1 **Open the terminal cover.**
- 2 **Connect the plug to the remote control terminal.**
  - Connect the plug as shown in the illustration.
  - To disconnect the plug, grasp the silver part and pull it out.

## Remote Control Shooting



With Remote Controller RC-6 (sold separately), you can shoot remotely up to approx. 5 meters/16.4 feet away from the camera (when you are facing the front of the camera). You can either shoot immediately or with a 2-sec. delay.

- 1 **Focus on the subject.**
- 2 **Set the lens's focus mode switch to <MF>.**
  - You can also shoot with <AF>.
- 3 **Press the <DRIVE•AF> button (Ⓞ6).**

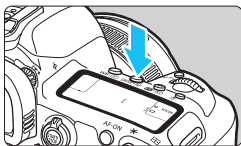

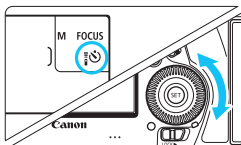

#### 4 Select the self-timer/remote controller.

- Look at the LCD panel or in the viewfinder and turn the <img alt="mode dial icon" data-bbox="755 180 785 200"/> dial to select <img alt="self-timer icon" data-bbox="455 200 475 220"/> or <img alt="self-timer with 2s icon" data-bbox="495 200 515 220"/>.

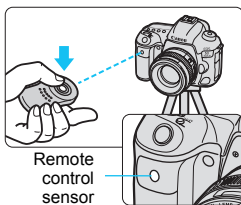

#### 5 Press the remote controller's transmit button.

- Point the remote controller toward the camera's remote control sensor, then press the transmit button.
- ▶ The self-timer lamp lights up and the picture is taken.

- ⚠ Fluorescent or LED lighting may cause camera misoperation by triggering the shutter inadvertently. Try to keep the camera away from such light sources.
- If you point a remote controller for a TV set toward the camera and operate it, it may cause camera misoperation by triggering the shutter inadvertently.
- If flash light is emitted from a flash on another camera around this camera, it may cause camera malfunction by triggering the shutter inadvertently. Do not expose the remote control sensor to flash light from a flash on another camera.

- 📄 You can also use Remote Controller RC-1 and RC-5.
- Remote control shooting is also possible with devices such as an EX-series Speedlite equipped with a remote-release function (sold separately).



## TIMER Interval Timer Shooting

With the interval timer, you can set the shooting interval and the number of shots. The camera will repeat taking one shot with the set interval until the set number of shots are taken.

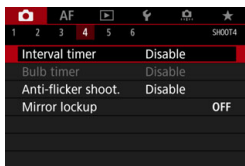

### 1 Select [Interval timer].

- Under the [**4**] tab (the [**2**] tab in <[A]<sup>+</sup>> mode), select [Interval timer], then press <[SET]>.

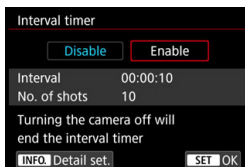

### 2 Select [Enable].

- Select [Enable], then press the <[INFO.]> button.

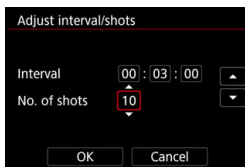

### 3 Set the shooting interval and number of shots.

- Select the number to be set (hours: minutes: seconds / number of shots).
- Press <[SET]> so <[ ]> is displayed.
- Set the desired number, then press <[SET]> (Returns to <[ ]>).

- Interval**

Settable from [00:00:01] to [99:59:59].

- No. of shots**

Settable from [01] to [99]. If you set [00], the camera will keep shooting until you stop the interval timer.

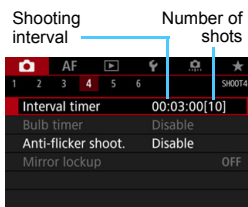

#### 4 Select [OK].

- ▶ The interval timer settings will be displayed on the menu screen.
- ▶ When you exit the menu, < **TIMER** > will be displayed on the LCD panel.

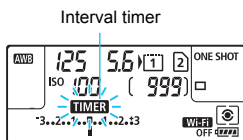

#### 5 Take the picture.

- ▶ First shot is taken and shooting continues according to the interval timer settings.
- During interval timer shooting, < **TIMER** > will blink.
- After the set number of shots are taken, the interval timer shooting will stop and be automatically canceled.



- Using a tripod is recommended.
- Taking test shots in advance is recommended.
- After the interval timer shooting starts, you can still press the shutter button completely to take a picture as usual. However, approx. 5 sec. before the next interval timer shooting, the shooting function settings, menu operation, image playback, and other operations will be suspended, and the camera will be ready to shoot.
- If a picture is being taken or an image is being processed when the next shot is scheduled on the interval timer, the shot set for that time will be skipped. The camera will thereby shoot fewer shots than the number set for interval timer shooting.
- Auto power off operates with the interval timer. The power will automatically turn on approx. 1 min. before the next shot.
- Interval timer shooting can also be combined with AEB, WB bracketing, multiple exposures, and HDR mode.
- You can stop the interval timer shooting by selecting [**Disable**] or turning the power switch to < **OFF** >.



- Do not point the camera toward an intense light source, such as the sun or an intense artificial light source. Doing so may damage the image sensor or the camera's internal components.
- If the lens's focus mode switch is set to <AF>, the camera will not shoot when focus is not achieved. Setting it to <MF> and focusing manually is recommended.
- Live View shooting, movie shooting, or bulb exposures cannot be performed with interval timer.
- For prolonged interval timer shooting, using the household power outlet accessories (sold separately, p.530) is recommended.
- If a shutter speed longer than the shooting interval, such as a long exposure, is set, the camera cannot shoot with the set interval. The camera will thereby shoot fewer still photos than the number set for interval timer shooting. Also, the number of shots may decrease when the shutter speed and the shooting interval are nearly the same.
- If the image recording time on the card is longer than the set shooting interval due to the shooting functions set, card performance, etc., some of the shots may not be taken with the set intervals.
- If you use flash with interval timer shooting, set an interval longer than the flash's recycling time. If the interval is too short, the flash may not fire.
- If the shooting interval is too short, the camera may not take a picture or may capture an image without autofocusing.
- Interval timer shooting will be canceled and reset to **[Disable]** if you do any of the following: Set the power switch to <OFF>, display the Live View shooting or movie shooting screen, set the shooting mode to <B>, <G1>, <G2>, or <G3>, or use EOS Utility (EOS software, p.598).
- After interval timer shooting starts, you cannot use remote control shooting (p.279) or remote-release shooting with an EOS-dedicated, external Speedlite.
- If your eye will not remain on the viewfinder eyepiece during interval timer shooting, attach the eyepiece cover (p.278). If stray light enters the viewfinder when the picture is taken, it may throw off the exposure.



# 7

## Flash Photography

This chapter explains how to shoot with external EX-series Speedlites (sold separately) and how to set Speedlite settings on the camera's menu screen.

## ⚡ Flash Photography

### EOS-dedicated, EX-series Speedlites



Using an EX-series Speedlite (sold separately) makes flash photography easy.

**For detailed instructions, refer to the EX-series Speedlite's Instruction Manual.** This camera is a Type-A camera that can use all the features of EX-series Speedlites.

To set the flash functions and flash Custom Functions on the camera's menu screen, see pages 289-295.

- **Flash exposure compensation**

In the same way as normal exposure compensation, flash output can be adjusted. You can set flash exposure compensation up to  $\pm 3$  stops in 1/3-stop increments.

Press the camera's **<  +ISO >** button, then turn the **<  >** dial while looking in the viewfinder or at the LCD panel.

- **FE lock**

This enables you to attain an appropriate flash exposure for a specific part of the subject. Aim the viewfinder center over the subject, press the camera's **< M-Fn >** button, then compose the shot and take the picture.



If [**2: Auto Lighting Optimizer**] (p.201) is set to any setting other than [**Disable**], the image may still look bright even if a decreased flash exposure compensation for a darker image is set.



If it is difficult to achieve focus with autofocus, the EOS-dedicated, external Speedlite will automatically emit the AF-assist beam as necessary.

## Canon Speedlites Other Than the EX-series

- **With an EZ/E/EG/ML/TL-series Speedlite set to A-TTL or TTL autoflash mode, the flash can be fired at full output only.** Set the camera's shooting mode to <**M**> manual exposure or <**Av**> aperture-priority AE and adjust the aperture setting before shooting.
- When using a Speedlite that has manual flash mode, shoot in the manual flash mode.

## Non-Canon Flash Units

### ● Sync Speed

The camera can synchronize with non-Canon compact flash units at 1/200 sec. and slower speeds. With large studio flash units, the flash duration is longer than that of a compact flash unit and varies depending on the model. Be sure to check before shooting if flash sync is properly performed by test shooting at a sync speed of approx. 1/60 sec. to 1/30 sec.

### ● PC Terminal

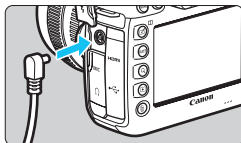

- The camera's PC terminal can be used with flash units having a sync cord. The terminal has locking threads to prevent the cord from falling off.
- The camera's PC terminal has no polarity. You can connect any sync cord regardless of its polarity.

### ● Cautions for Live View Shooting

If you use a non-Canon flash unit with Live View shooting, set [**6**: Silent LV shoot.] to [**Disable**] (p.312). The flash will not be fired if it is set to [**Mode 1**] or [**Mode 2**].

- If the camera is used with a flash unit or flash accessory dedicated to another camera brand, the camera may not operate properly and malfunction may result.
- Do not connect to the camera's PC terminal any flash unit with an output voltage of 250 V or more.
- Do not attach a high-voltage flash unit to the camera's hot shoe. It may not be fired.

 A flash unit attached to the camera's hot shoe and a flash unit connected to the PC terminal can both be used at the same time.



## MENU Setting the Flash Function ☆

With an EX-series Speedlite having compatible flash function settings, you can use the camera's menu screen to set the Speedlite's functions and Custom Functions. **Attach the Speedlite to the camera and turn on the Speedlite before setting the flash functions.**

For details on the Speedlite's functions, refer to the Speedlite's Instruction Manual.

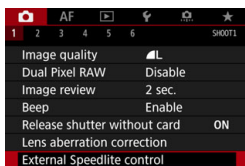

### 1 Select [External Speedlite control].

- Under the [1] tab, select [External Speedlite control], then press <SET>.
- The external Speedlite control screen will appear.

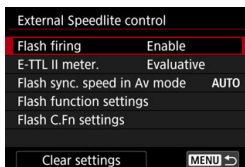

### 2 Select the desired item.

- Select the menu option to be set, then press <SET>.

## Flash Firing



To enable flash photography, set [Enable]. To enable only the AF-assist beam to be emitted, set [Disable].

## E-TTL II Flash Metering

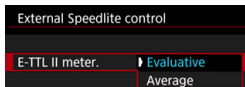

For normal flash exposures, set it to [Evaluative]. If [Average] is set, the flash exposure will be averaged for the entire metered scene. Depending on the scene, flash exposure compensation may be necessary. This setting is for advanced users.

## Flash Sync. Speed in Av Mode

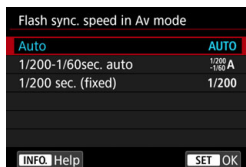

You can set the flash-sync speed for flash photography in the <Av> aperture-priority AE mode.

- **AUTO: Auto**

The flash sync speed is set automatically within a range of 1/200 sec. to 30 sec. to suit the scene's brightness. High-speed sync is also possible.

- **<sup>1/200</sup>/<sub>-1/60</sub>A: 1/200-1/60sec. auto**

Prevents a slow shutter speed from being set in low-light conditions. It is effective for preventing subject blur and camera shake. However, while the subject will be properly exposed with the flash, the background may come out dark.

- **1/200: 1/200 sec. (fixed)**

The flash sync speed is fixed at 1/200 sec. This more effectively prevents subject blur and camera shake than with [1/200-1/60sec. auto]. However, in low light, the subject's background will come out darker than with [1/200-1/60sec. auto].

ⓘ If [1/200-1/60sec. auto] or [1/200 sec. (fixed)] is set, high-speed sync is not possible in the <Av> mode.

## Flash Function Settings

The screen display and setting options will vary depending on the Speedlite model, current flash mode, Speedlite's Custom Function settings, etc.

For details on the Speedlite's functions, refer to the Speedlite's Instruction Manual.

### Sample display

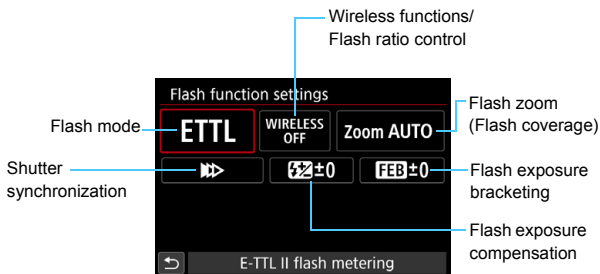

#### ● Flash mode

You can select the flash mode to suit your desired flash shooting.

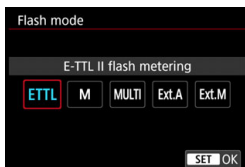

**[E-TTL II flash metering]** is the standard mode of EX-series Speedlites for automatic flash shooting.

**[Manual flash]** is for setting the Speedlite's **[Flash output level]** yourself.

Regarding other flash modes, refer to the Instruction Manual of a Speedlite compatible with the functions.

● **Wireless functions / Flash ratio control**

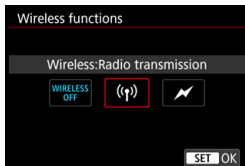

Wireless (multiple) flash shooting is possible with radio or optical transmission.

For details on wireless flash, refer to the Instruction Manual of a Speedlite compatible with wireless flash shooting.



With a macro flash (MR-14EX II, etc.) compatible with flash function settings, you can set the flash ratio between flash tubes or flash heads A and B, or use wireless flash with additional receiver units.

For details on flash ratio control, refer to the macro flash's Instruction Manual.

● **Flash zoom (Flash coverage)**

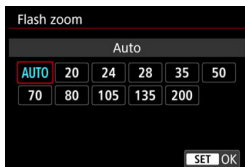

With Speedlites having a zooming flash head, you can set the flash coverage. Normally, set this to **[AUTO]** so that the camera will automatically set the flash coverage to match the lens focal length.

## ● Shutter synchronization

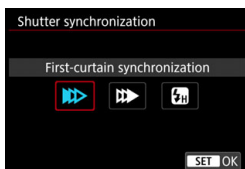

Normally, set this to **[First-curtain synchronization]** so that the flash fires immediately after the exposure starts.

If **[Second-curtain synchronization]** is set, the flash will be fired right before the shutter closes. When this is combined with a slow shutter speed, you can create a trail of light such as from car headlights at night with a more natural feel. When second-curtain synchronization is set together with **[ETTL II]**, the flash will be fired twice in a row: once when you press the shutter button completely and once right before the end of the exposure.

If **[High-speed synchronization]** is set, the flash can be used at all shutter speeds. This is effective when you want to shoot with background blur (open aperture) in locations such as outdoors in daylight.

## ● Flash exposure compensation

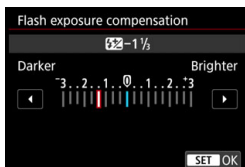

You can set flash exposure compensation up to  $\pm 3$  stops in 1/3-stop increments.

For details, refer to the Speedlite's Instruction Manual.

## ● Flash exposure bracketing

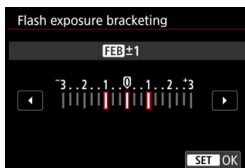

While changing the flash output automatically, three shots will be taken. For details, refer to the Instruction Manual of a Speedlite equipped with flash exposure bracketing.

⚠ When using second-curtain synchronization, set the shutter speed to 1/25 sec. or slower. If the shutter speed is 1/30 sec. or faster, first-curtain synchronization will be applied automatically even if [**Second-curtain synchronization**] is set.

- 📄 With an EX-series Speedlite not compatible with flash function settings, you can only set the following: [**Flash firing**], [**E-TTL II meter.**], and [**Flash exposure compensation**] under [**Flash function settings**]. ([**Shutter synchronization**] can also be set with certain EX-series Speedlites.)
- If flash exposure compensation is set with the Speedlite, you cannot set the flash exposure compensation with the camera. If it is set with both the camera and Speedlite, the Speedlite's setting overrides the camera's.

## Flash Custom Function Settings

For details on the Speedlite's Custom Functions, refer to the Speedlite's (sold separately) Instruction Manual.

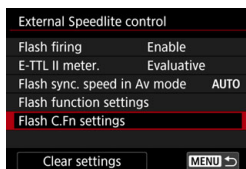

1 Select [**Flash C.Fn settings**].

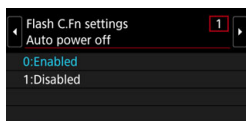

2 Set the desired functions.

- Select the number, then press <SET>.
- Select the setting, then press <SET>.

⚠ With an EX-series Speedlite, the Speedlite will always fire at full output if the [**Flash metering mode**] Custom Function is set to [**TTL flash metering**] (autoflash).

## Clearing Flash Function Settings / Flash C.Fn Settings

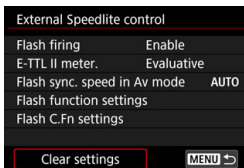

### 1 Select [Clear settings].

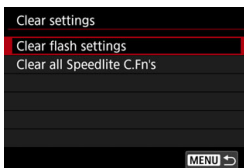

### 2 Select the settings to be cleared.

- Select [**Clear flash settings**] or [**Clear all Speedlite C.Fn's**], then press < (SET) >.
- On the confirmation dialog, select [**OK**]. Then the flash settings or Custom Function settings will all be cleared.



The Speedlite's Personal Function (P.Fn) cannot be set or canceled on the camera's [**External Speedlite control**] screen. Set it directly on the Speedlite.





# 8

## Shooting with the LCD Monitor (Live View Shooting)



You can shoot while viewing the image on the camera's LCD monitor. This is called "Live View shooting".

Live View shooting is enabled by setting the Live View shooting/Movie shooting switch to <img alt="Live View shooting/Movie shooting switch icon" data-bbox="758 591 798 611"/>.

- If you handhold the camera and shoot while viewing the LCD monitor, camera shake may cause blurred images. Using a tripod is recommended in such cases.

### Remote Live View Shooting

With EOS Utility (EOS software, p.598) installed on your computer, you can connect the camera to the computer and shoot remotely while viewing the computer screen. For details, refer to the EOS Utility Instruction Manual (p.600).

## Shooting with the LCD Monitor

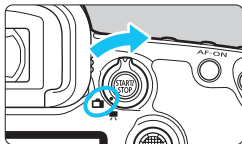

- 1** Set the Live View shooting/Movie shooting switch to .



- 2** Display the Live View image.

- Press the  button.
- ▶ The Live View image will appear on the LCD monitor.
- The Live View image will be displayed in the brightness level closely matching that of the actual image to be captured.

- 3** Select the shooting mode.

- Turn the Mode Dial to select the shooting mode.

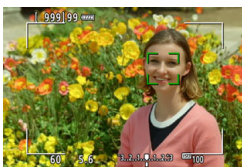

- 4** Focus on the subject.

- When you press the shutter button halfway, the camera will focus with the current AF method (p.316).
- You can also tap on the screen to select the face or subject (p.327).

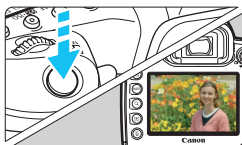

- 5** Take the picture.

- Press the shutter button completely.
- ▶ The picture is taken and the captured image is displayed on the LCD monitor.
- ▶ When the playback display ends, the camera will return to Live View shooting automatically.
- Press the  button to exit the Live View shooting.

## Enabling Live View Shooting

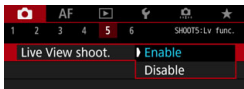

Set [**5**: Live View shoot.] (the [**3**] tab in <[A]<sup>+</sup>> mode) to [**Enable**].

## Number of Possible Shots with Live View Shooting

(Approx. number of shots)

Temperature	Room Temperature (23°C / 73°F)	Low Temperatures (0°C / 32°F)
Possible shots	300	280

- The figures above are based on a fully-charged Battery Pack LP-E6N and CIPA (Camera & Imaging Products Association) testing standards.
- With Battery Grip BG-E20 (sold separately) loaded with two LP-E6N battery packs, the number of possible shots will be doubled.
- With a fully-charged Battery Pack LP-E6N, the total continuous Live View shooting time will be as follows: At room temperature (23°C/73°F): Approx. 2 hr. 40 min., At low temperatures (0°C/32°F): Approx. 2 hr. 30 min.

## Continuous Shooting Display

For <[H]> High-speed continuous shooting during Live View shooting with the image-recording quality set to JPEG or **RAW** (except **M RAW** and **S RAW**), holding down the shutter button will display (played back) the captured images continuously. When the continuous shooting ends (shutter button is returned to halfway position), the Live View image will be displayed.

- Depending on the shooting conditions such as when an external Speedlite is used or shooting long exposures, the captured images may not be displayed (played back) continuously.

- ⚠️ Do not point the camera toward an intense light source, such as the sun or an intense artificial light source. Doing so may damage the image sensor or the camera's internal components.

- “**General Live View Shooting Cautions**” are on pages 331-332.

- 📄 The image's field of view is approx. 100% (with image-recording quality set to JPEG **L** and aspect ratio set to 3:2).
- You can set exposure compensation up to  $\pm 3$  stops by setting the <LOCK▶> switch to the left and turning the <☉> dial (except in the <A+> mode).
- To check the depth of field, press the depth-of-field preview button.
- If you shoot with the image-recording quality set to **M RAW** or **S RAW**, “**BUSY**” will be displayed and shooting will be disabled temporarily.
- You can also focus by pressing the <AF-ON> button.
- When flash is used, there will be two shutter sounds, but only one shot will be taken. Also, the time it takes to take the picture after you press the shutter button completely will be slightly longer than with viewfinder shooting.
- If the camera is not operated for a prolonged period, the power will turn off automatically after the time set in [**⚡2: Auto power off**] (p.76). If [**⚡2: Auto power off**] is set to [**Disable**], Live View shooting will end automatically after approx. 30 min. (camera power remains on).
- With the HDMI cable HTC-100 (sold separately), you can display the Live View image on a TV set (p.432). Note that no sound will be output. If the picture does not appear on the TV screen, check if the [**⚡3: Video system**] is correctly set to [**For NTSC**] or [**For PAL**] (depending on the video system of your TV set).
- You can also use a remote controller (sold separately, p.279) for Live View shooting.

## Information Display

Each time you press the <INFO.> button, the information display will change.

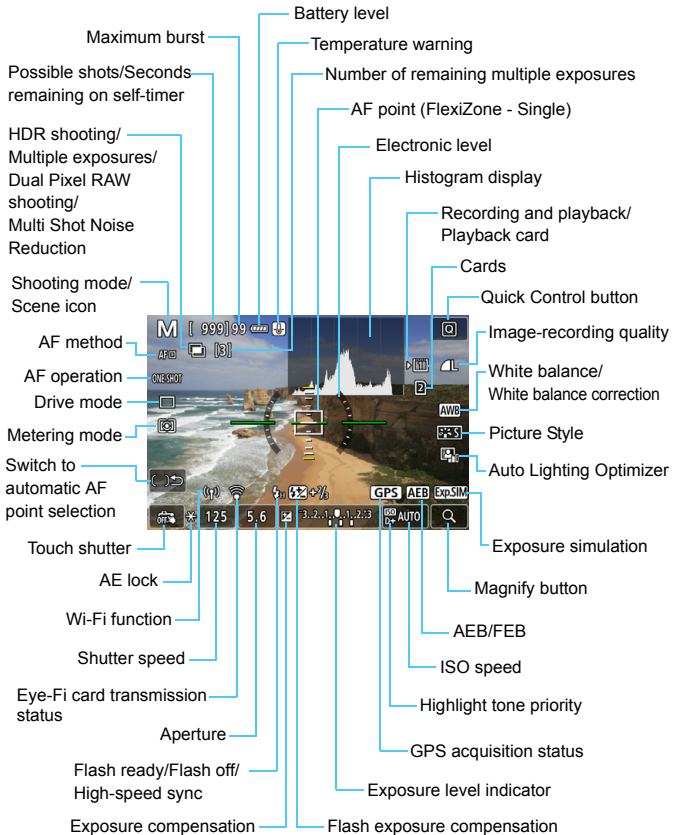

- The display will show only the settings currently applied.

## ⚠️ Warnings

**Do not hold the camera in the same position for long periods of time.**

Even if the camera does not feel too hot, prolonged contact with the same body part may cause skin redness or blistering due to low-temperature contact burns. Using a tripod is recommended for people with circulation problems or very sensitive skin, or when using the camera in very hot places.



- The histogram can be displayed when [**📷5: Expo. simulation**] is set to [**Enable**] (p.311).
- You can display the electronic level by pressing the <INFO.> button (p.82). Note that if the AF method is set to [**☺+Tracking**] or if the camera is connected to a TV set with an HDMI cable, the electronic level cannot be displayed.
- When <Exp.SIM> is displayed in white, it indicates that the Live View image is displayed at the brightness level closely matching that of the actual image to be captured.
- If <Exp.SIM> is blinking, it indicates that the Live View image is displayed at a brightness that differs from the actual shooting result because of low- or bright-light conditions. However, the actual image recorded will reflect the exposure setting. Note that the noise may be more noticeable than the actual image recorded.
- Exposure simulation (p.311) will not work with bulb or flash shooting, Multi Shot Noise Reduction, or the HDR mode. The <Exp.SIM> icon and histogram will be displayed in gray. The image will be displayed on the LCD monitor at the standard brightness. The histogram may not be properly displayed in low- or bright-light conditions.

## Scene Icons

In the  $\langle \text{A}^+ \rangle$  shooting mode, the camera detects the scene type and sets everything automatically to suit the scene. The detected scene type is indicated on the upper left of the screen.

Subject Background	Portrait* <sup>1</sup>		Non-portrait			Background Color
		Movement	Nature and Outdoor Scene	Movement	Close* <sup>2</sup>	
Bright						Gray
Backlit						
Blue Sky Included						Light blue
Backlit						
Sunset	* <sup>3</sup>			* <sup>3</sup>		Orange
Spotlight						Dark blue
Dark						
With Tripod	* <sup>4*5</sup>	* <sup>3</sup>	* <sup>4*5</sup>	* <sup>3</sup>		

\*1: Displayed only when the AF method is set to  $\langle \text{A}^+ \text{Tracking} \rangle$ . If another AF method is set, the “Non-portrait” icon will be displayed even if a person is detected.

\*2: Displayed when the attached lens has distance information. With an extension tube or close-up lens, the icon displayed may not match the actual scene.

For certain scenes or shooting conditions, the icon displayed may not match the actual scene.

\*3: The icon of the scene selected from the detectable scenes will be displayed.

\*4: Displayed when all the following conditions apply:

The shooting scene is dark, it is a night scene, and the camera is mounted on a tripod.

\*5: Displayed with any of the lenses below:

EF300mm f/2.8L IS II USM

EF400mm f/2.8L IS II USM

EF500mm f/4L IS II USM

EF600mm f/4L IS II USM

Image Stabilizer lenses released in or after 2012.

\*4+\*5: If the conditions in both \*4 and \*5 are met, the shutter speed will slow down.

## Final Image Simulation

Final image simulation is a function that shows the Live View image with the effects of the current settings for Picture Style, white balance, and other shooting functions applied.

The Live View image will automatically reflect the function settings listed below. However, it may be slightly different from the resulting image.

### Final Image Simulation During Live View Shooting

- Picture Style

- \* Sharpness (Strength), contrast, color saturation, and color tone will be reflected.

- White balance

- White balance correction

- Metering mode

- Exposure (with [ 5: Expo. simulation: Enable] set)

- Depth of field (with depth-of-field preview button ON)

- Auto Lighting Optimizer

- Peripheral illumination correction

- Distortion correction

- Chromatic aberration correction

- Highlight tone priority

- Aspect ratio (Image area confirmation)



## INFO. Button Display Options

You can set the information to be displayed on the image for when you press the <INFO.> button during Live View shooting or movie shooting.

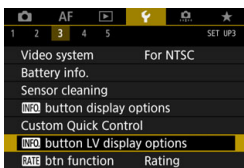

### Select [**INFO**] button LV display options].

- Under the [**3**] tab, select [**INFO**] button LV display options], then press <SET>.

### Live View info switch setting

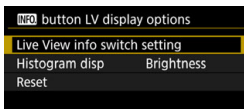

### 1 Select [Live View info switch setting].

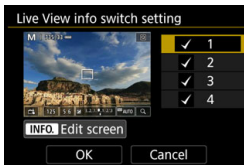

### 2 Select a number.

- The numbers indicate the number of times to press the <INFO.> button.
- Select a number for the displayed information you want to change, then press the <INFO.> button.
- To remove a number's checkmark [✓], press <SET>. Note that you cannot remove the [✓] for all four display options.

The default settings are shown below.

Information / Number	1	2	3	4
Basic shooting info	<input type="radio"/>	<input type="radio"/>	<input type="radio"/>	–
Detailed shooting info	–	<input type="radio"/>	<input type="radio"/>	–
On-screen buttons	<input type="radio"/>	<input type="radio"/>	<input type="radio"/>	–
Histogram	–	–	<input type="radio"/>	–
Electronic level	–	–	<input type="radio"/>	–

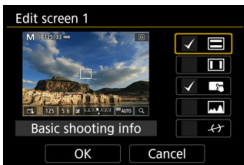

### 3 Edit the options.

- Select what you want to be displayed and press **<SET>** to add a checkmark [✓].
- For the information you do not want to be displayed, press **<SET>** to remove the checkmark [✓].
- Select **[OK]** to register the setting.
- Repeat steps 2 and 3 as necessary.

## • Histogram display

### • Brightness/RGB

The histogram (p.402) to be displayed when you press the **<INFO.>** button can be either the **[Brightness]** or **[RGB]** histogram.

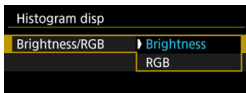

Under **[Histogram disp]**, select **[Brightness/RGB]** and select **[Brightness]** or **[RGB]**.

### • Display size

You can change the display size of the histogram.







Under **[Histogram disp]**, select **[Display size]** and select **[Large]** or **[Small]**.



## • Reset



In step 1, if you select **[Reset]**, the **[INFO: INFO] button LV display options** setting will be cleared.



# Shooting Function Settings

## WB//DRIVE/AF//ISO///HDR Settings

When the Live View image is displayed, if you press the <WB·>, <DRIVE·AF>, <·ISO>, or <> button, the setting screen will appear on the LCD monitor and you can turn the <> or <> dial to set the respective shooting function.

- By pressing the <WB·> button and then the <INFO.> button, you can set white balance shift and white balance bracketing.
- After you press the <> button and select <> or <HDR>, the menu screen for Multiple exposure or HDR mode will appear.

 With Live View shooting, the <S> and <S> drive modes cannot be set. Also, the continuous shooting mode set for viewfinder shooting will not be applied to Live View shooting.

 When you set  (Partial metering) or  (Spot metering), a metering circle will be displayed at the center of the screen.

## Q Quick Control

In the <P>, <Tv>, <Av>, <M>, and <B> modes, you can set the **AF method**, AF operation, **Drive mode**, Metering mode, **Recording/playing back card and image quality**, White balance, Picture Style, and Auto Lighting Optimizer.

In the <A+> mode, only the functions in bold above can be set.



### 1 Press the <Q> button (10).

- ▶ The settable functions will be displayed.

### 2 Select a function and set it.





- Use <OK> to select a function.
- ▶ The setting of the selected function is displayed on the screen.
- Turn the <Sun> or <Clock> dial to set it.
- To set the RAW image-recording quality, press <SET>.
- Press the <INFO.> button for the following: To select the card for recording and playback, to set the white balance shift or white balance bracketing, or to set Picture Style parameters.
- To set Auto white balance, select [AWB], then press <SET>.
- To return to Live View shooting, press <SET> or the <Q> button.
- You can also select [↶] to return to Live View shooting.

⚠ With [AF operation] set to [Servo AF], you cannot select M RAW or S RAW when setting a RAW quality for [Recording quality].

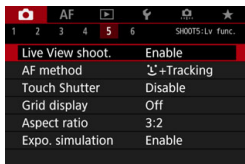
## MENU Menu Function Settings

### 5



When the Live View shooting/Movie shooting switch is set to , menu options exclusive to the Live View shooting will appear under the [] and [] tabs (the [] tab in  mode).

The settable functions on this menu screen apply only to Live View shooting. They do not work with viewfinder shooting (settings are disabled).

- **Live View shooting**

You can set Live View shooting to **[Enable]** or **[Disable]**.



- **AF method**

You can select **[L+Tracking]**, **[FlexiZone - Multi]**, or **[FlexiZone - Single]**. See pages 316-322 for the AF method.

- **Touch Shutter**

You can set touch shutter to **[Enable]** or **[Disable]**. Just by tapping on the LCD monitor screen, you can focus and take the picture automatically. For details, see page 327.

- **Grid display**

With **[3x3 **] or **[6x4 **], you can display grid lines to help you level the camera vertically or horizontally. Also, with **[3x3+diag **], the grid is displayed together with diagonal lines to help you compose with better balance by aligning the intersections over the subject.

### ● Aspect ratio <sup>☆</sup>

The image's aspect ratio can be set to **[3:2]**, **[4:3]**, **[16:9]**, or **[1:1]**. The area surrounding the Live View image is masked in black when the following aspect ratios are set: **[4:3]** **[16:9]** **[1:1]**.

JPEG images will be saved with the set aspect ratio. RAW images will always be saved with the **[3:2]** aspect ratio. Since the aspect ratio information is appended to the RAW image, the image can be created in the respective aspect ratio when you process the RAW image with the camera or Digital Photo Professional software (p.598). If you playback the RAW image with the camera, frame lines indicating the aspect ratio (image area) will be displayed.

Image Quality	Aspect Ratio and Pixel Count (Approx.)			
	3:2	4:3	16:9	1:1
L	6720x4480 (30.1 megapixels)	5952x4480* (26.7 megapixels)	6720x3776* (25.4 megapixels)	4480x4480 (20.1 megapixels)
M	4464x2976 (13.3 megapixels)	3968x2976 (11.8 megapixels)	4464x2512* (11.2 megapixels)	2976x2976 (8.9 megapixels)
S1	3360x2240 (7.5 megapixels)	2976x2240* (6.7 megapixels)	3360x1888* (6.3 megapixels)	2240x2240 (5.0 megapixels)
S2	1920x1280 (2.5 megapixels)	1696x1280* (2.2 megapixels)	1920x1080 (2.1 megapixels)	1280x1280 (1.6 megapixels)
S3	720x480 (350,000 pixels)	640x480 (310,000 pixels)	720x408* (290,000 pixels)	480x480 (230,000 pixels)

- The asterisked image-recording quality settings do not match the respective aspect ratio exactly.
- The photo image area displayed for the asterisked aspect ratio may be slightly different from the actual photo image area. Check the captured images on the LCD monitor when shooting.
- The picture will be taken at the **[3:2]** aspect ratio setting for the multiple-exposures.

- **Exposure simulation** ☆

Exposure simulation simulates and displays how the brightness (exposure) of the actual image will look.

- **Enable** (Exp.SIM)

The displayed image brightness will be close to the actual brightness (exposure) of the resulting image. If you set exposure compensation, the image brightness will change accordingly.

- **During** (DISP)

Normally, the image is displayed at the standard brightness to make the Live View image easy to see (DISP). The image will be displayed with a brightness (exposure) close to that of the actual image to be captured only while you hold down the depth-of-field preview button (Exp.SIM).

- **Disable** (DISP)

The image is displayed at the standard brightness to make the Live View image easy to see. Even if you set exposure compensation, the image is displayed at the standard brightness.

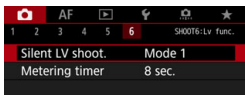
 6 ☆

- **Silent LV shooting** ☆

- **Mode 1**

Mechanical sound during shooting is suppressed, compared with viewfinder shooting. Continuous shooting is also possible.

- **Mode 2**

When the shutter button is pressed completely, only one shot will be taken. While you keep holding down the shutter button, the camera operation will be suspended. Then when you return to the shutter button's halfway position, the camera operation will resume. The release sound at the moment of shooting can thereby be minimized. Even if continuous shooting is set, only a single shot will be taken.

- **Disable**

With the drive mode set to <[H]> and [AF operation] set to [One-Shot AF], you can shoot up to the maximum continuous shooting speed of approx. 7.0 shots/sec.

Be sure to set it to [Disable] if you use a TS-E lens **for shifting or tilting the lens** or if you use an extension tube. If [Mode 1] or [Mode 2] is set, the standard exposure may not be obtained, or an irregular exposure may result.









- With **[Mode 2]** set, continuous shooting will not work even if you set the drive mode to <img alt="H icon" data-bbox="345 128 375 145"/> or <img alt="L icon" data-bbox="445 128 475 145"/>.
- If you use flash with the flash mode set to E-TTL II/E-TTL autofocus, shutter release will be performed by the same internal operation mechanism as with viewfinder shooting. Therefore, shooting while suppressing the mechanical sound will not be possible (regardless of the **[Silent LV shoot.]** setting).
- When using a non-Canon flash unit, set it to **[Disable]**. The flash will not be fired if it is set to **[Mode 1]** or **[Mode 2]**.
- If **[Mode 2]** is set and you use a remote controller (p.279), the operation will be the same as with **[Mode 1]**.

### ● Metering timer <sup>★</sup>

You can change how long the exposure setting is displayed (AE lock time).



Selecting any of the items below will cancel Live View shooting. To start Live View shooting again, press the <img alt="START/STOP button" data-bbox="485 875 515 895"/> button.

- **[3: Dust Delete Data]**, **[3: Sensor cleaning]**, **[5: Clear all camera settings]**, or **[5:  firmware ver.]**.

# Selecting the AF Operation ☆

You can select the AF operation characteristics to suit the shooting conditions or subject. In the <A+> mode, [One Shot AF] is set automatically.

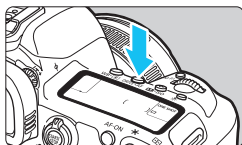

1 Press the <DRIVE-AF> button.

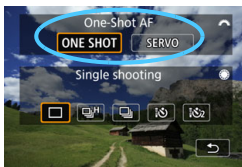

2 Select the AF operation.

- Turn the <G> dial to select the desired AF operation, then press <SET>.

**ONE SHOT**: One-Shot AF

**SERVO**: Servo AF

- Settable only for Live View shooting (not settable for movie shooting).
- If focus cannot be achieved, the AF point will turn orange. If this occurs, the picture cannot be taken even if the shutter button is pressed completely. Recompose the shot and try to focus again. Or, see “Shooting Conditions that Make Focusing Difficult” (p.324).

## One-Shot AF for Still Subjects



**Suited for still subjects. When you press the shutter button halfway, the camera will focus only once.**

- When focus is achieved, the AF point will turn green.
- The focus remains locked while you hold down the shutter button halfway, allowing you to recompose the image before taking the picture.
- For flash photography, the continuous shooting speed will become slower.

- If [CAM 1: Beep] is set to [Disable], the beeper will not sound when focus is achieved.

## Servo AF for Moving Subjects

This AF operation is suited for moving subjects. While you hold down the shutter button halfway, the camera will keep focusing on the subject continuously.

- When the drive mode is set to  for high-speed continuous shooting, the maximum continuous shooting speed will be approx. 4.3 shots/sec. The pictures will be taken with priority given to the continuous shooting speed. With the  low-speed continuous shooting setting, “Subject-tracking priority” will be used for shooting.
- For flash photography, the continuous shooting speed will become slower.
- When focus is achieved, the AF point will turn blue.
- The exposure is set at the moment the picture is taken.
- When [AF method] is set to [ +Tracking] or [Flexizone - Multi], focusing will be continuous as long as the area frame can track the subject.



- Depending on the lens used, the distance to the subject, and the subject's speed, the camera may not be able to achieve correct focus.
- Zooming during continuous shooting may throw off the focus. Zoom first, then recompose and shoot.
- When [Servo AF] is set, the image-recording quality cannot be set to **M RAW** or **S RAW**. If **M RAW** or **S RAW** is set, the image will be recorded in **RAW** quality.
- When [Servo AF] is set and [Multi Shot Noise Reduction] is set (p.202), [High ISO speed NR] will automatically switch to [Standard].
- If [Servo AF] is set, pressing the button assigned for the function will not take effect if you set **M RAW** or **S RAW** image-quality for the [One-touch image quality setting] or [One-touch image quality (hold)] (p.507) with [ 3: Custom Controls].



With Servo AF, the beeper will not sound even when focus is achieved.

# Focusing with AF (AF Method)

## Selecting the AF Method

You can set the AF method to [**L**+Tracking] (p.317), [**FlexiZone - Multi**] (p.319), or [**FlexiZone - Single**] (p.321) to suit the shooting conditions and subject.

If you want to achieve precise focus, set the lens's focus mode switch to <MF>, magnify the image, and focus manually (p.329).

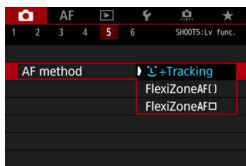

## Select the AF method.

- Under the [**5**] tab (the [**3**] tab in <[A]<sup>+</sup>> mode), select [**AF method**].
- Select the desired AF method, then press <[SET]>.
- When the Live View image is displayed, you can press the <DRIVE•AF> button to select the AF operation (p.314).



- The explanations on pages 317-322 assume that [**AF operation**] is set to [**One Shot AF**] (p.314). With [**Servo AF**] (p.315) set, the AF point will turn blue when focus is achieved.
- Regarding the touch shutter (AF and shutter release by tapping on the screen), see page 327.

**☺ (face)+Tracking: AF**

The camera detects and focuses on human faces. If a face moves, the AF point <☺> also moves to track the face.

**1 Display the Live View image.**

- Press the <START/STOP> button.
- ▶ The Live View image will appear on the LCD monitor.



Area frame

**2 Select an AF point.**

- When a face is detected, the area frame will be displayed and <☺> will appear over the face to be focused on.
- If multiple faces are detected, <☺> will be displayed. Use <☺> to move <☺> over the face you want to focus on.
- You can also tap on the LCD monitor screen to select the face or subject. If you tap on a subject other than a human face, the AF point will be switched to <☺>.

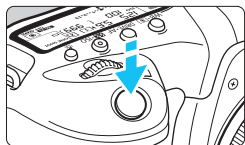
**3 Focus on the subject.**

- Press the shutter button halfway to focus.
- ▶ If no faces can be detected or if you do not tap anything on the screen, the camera will switch to FlexiZone - Multi (p.319).
- ▶ When focus is achieved, the AF point will turn green and the beeper will sound.
- ▶ If focus is not achieved, the AF point will turn orange.



## 4 Take the picture.

- Check the focus and exposure, then press the shutter button completely to take the picture (p.298).

### ● Focusing on a subject other than a human face

- Tap on the subject (or spot) where you want to focus.
- Press  $\langle \text{AF-ON} \rangle$  or  $\langle \text{SET} \rangle$  and the AF point  $\langle \text{AF} \rangle$  will appear on the screen. Then use  $\langle \text{AF-ON} \rangle$  to move the AF point over the target subject.
- Once the AF point  $\langle \text{AF} \rangle$  achieves focus, it will track the subject even if the subject moves or if you change the composition.

- If the subject's face is significantly out of focus, face detection will not be possible. Adjust the focus manually (p.329) so that the face can be detected, then perform AF.
- An object other than a human face may be detected as a face.
- Face detection will not work if the face is very small or large in the picture, too bright or too dark, or partially hidden.
- The  $\langle \text{AF} \rangle$  may cover only part of the face.

- AF is not possible with a face or subject along the periphery. Aim the area frame over the subject and focus.
- The size of the AF point changes depending on the subject.

## FlexiZone - Multi: AF ( )

You can use up to 63 AF points for wide-area focusing (automatic selection). This wide area can also be divided into 9 zones for focusing (zone selection).



Area frame

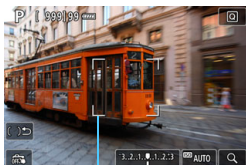

Zone frame

### 1 Display the Live View image.

- Press the  $\langle \text{START/STOP} \rangle$  button.
- ▶ The Live View image will appear on the LCD monitor.

### 2 Select the AF point. ☆

- Pressing  $\langle \text{AF} \rangle$  or  $\langle \text{SET} \rangle$  will toggle between automatic selection and zone selection. In the  $\langle \text{AF} \rangle$  mode, automatic selection is set automatically.
- Use  $\langle \text{AF} \rangle$  to select the zone. To return to the center zone, press  $\langle \text{AF} \rangle$  or  $\langle \text{SET} \rangle$  again.
- You can also tap on the LCD monitor screen to select a zone. When a zone is selected, tap  $[\text{OK}]$  on the screen to switch to automatic selection.

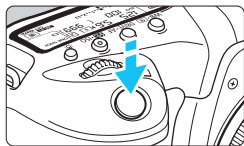

### 3 Focus on the subject.

- Aim the AF point over the subject and press the shutter button halfway.
- ▶ When focus is achieved, the AF point will turn green and the beeper will sound.
- ▶ If focus is not achieved, the area frame will turn orange.



### 4 Take the picture.

- Check the focus and exposure, then press the shutter button completely to take the picture (p.298).

- If the camera does not focus the desired target subject with automatic selection, switch the AF method to zone selection or [**FlexiZone - Single**] (p.321) and refocus.
- With Live View shooting, the number of AF points will differ depending on the [**5: Aspect ratio**] setting. When the aspect ratio is [**3:2**], [**4:3**], or [**16:9**], there will be 63 AF points and 9 zones. For [**1:1**], 49 AF points and 9 zones.
- For movie shooting, the number of AF points and zones will differ depending on the [**Movie recording size**] setting. With **FHD** **HD** shooting, there will be 63 AF points and 9 zones. For **4K** shooting, 15 AF points and 3 zones.



## FlexiZone - Single: AF □

The camera focuses with a single AF point. This is effective when you want to focus on a particular subject.



AF point

### 1 Display the Live View image.

- Press the < START/STOP > button.
- ▶ The Live View image will appear on the LCD monitor.
- ▶ The AF point < □ > will appear.
- If [Movie servo AF] is set to [Enable], the AF point will be displayed larger.



### 2 Move the AF point.

- Use < ⦿ > to move the AF point to where you want to focus. (It cannot be moved to the edge of the screen.)
- Using < ⦿ > or < (SET) > will return the AF point to the screen center.
- You can also tap on the LCD monitor screen to move the AF point.

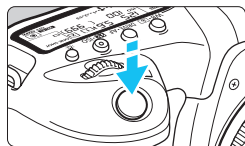

### 3 Focus on the subject.

- Aim the AF point over the subject and press the shutter button halfway.
- ▶ When focus is achieved, the AF point will turn green and the beeper will sound.
- ▶ If focus is not achieved, the AF point will turn orange.



## 4 Take the picture.

- Check the focus and exposure, then press the shutter button completely to take the picture (p.298).

## Notes for AF

### AF Operation

- Even when focus is achieved, pressing the shutter button halfway will focus again.
- The image brightness may change during and after the AF operation.
- Depending on the subject and shooting conditions, it may take longer to focus or the continuous shooting speed may decrease.
- If the light source changes while the Live View image is displayed, the screen may flicker and focusing may be difficult. If this happens, exit Live View shooting and perform AF under the actual light source under which you are shooting.



- If you cannot achieve focus with AF, set the lens's focus mode switch to <MF> and focus manually (p.329).
- If you shoot the subject at the periphery and it is slightly out of focus, recompose to move the subject (and AF point or zone) toward the screen center, focus again, then take the picture.
- The external Speedlite will not emit the AF-assist beam. However, if an EX-series Speedlite (sold separately) equipped with an LED light is used, the LED light will turn on for AF-assist when necessary.
- With certain lenses, it may take more time to achieve focus with autofocus, or accurate focusing may not be achieved.

## Shooting Conditions that Make Focusing Difficult

- Subject with low-contrast such as the blue sky, solid-color flat surfaces or when highlight or shadow details are clipped.
- Subjects in low light.
- Stripes and other patterns where there is contrast only in the horizontal direction.
- Subjects with repetitive patterns (Example: Skyscraper windows, computer keyboards, etc.).
- Fine lines and subject outlines.
- Under a light source whose brightness, color, or pattern keeps changing.
- Night scenes or points of light.
- The image flickers under fluorescent or LED lighting.
- Extremely small subjects.
- Subjects at the edge of the picture.
- Strongly backlit or reflective subjects (Example: Car with a highly reflective body, etc.).
- Near and distant subjects covered by an AF point (Example: Animal in a cage, etc.).
- Subjects that keep moving within the AF point and will not stay still due to camera shake or subject blur.
- Performing AF when the subject is very far out of focus.
- Soft focus effect is applied with a soft focus lens.
- A special effect filter is used.
- Noise (dots of light, banding, etc.) appears on the screen during AF.

## Magnified View

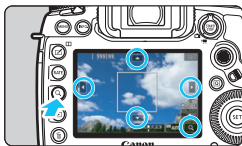

In the **[FlexiZone - Multi]** and **[FlexiZone - Single]** modes, either press the **<Q>** button or tap on **[Q]** displayed on the bottom right of the screen. You can magnify the image by approx. 5x or 10x and check the focus.

Magnified view is not possible with **[L+Tracking]**.

- To move the AF point or select a zone, operate **<AF-ON>** or tap on the spot you want to magnify.
- Either press the **<Q>** button or tap on **[Q]** to magnify the image. Each time you press the **<Q>** button or tap on **[Q]**, the magnification ratio changes.
- When **[FlexiZone - Multi]** is set, the image will be magnified at the center of the zone frame (or image center with automatic selection). When **[FlexiZone - Single]** is set, the image will be magnified at the AF point.
- At 100% (approx. 1x) magnification, operate **<AF-ON>** or tap on the screen to move the magnifying frame. Pressing **<AF-ON>** or **<SET>** will return the magnifying frame to the screen center.
- Either press the **<Q>** button or tap on **[Q]** to magnify the area covered by the magnifying frame.
- When the image is magnified by approx. 5x or 10x, you can change the magnified area by operating **<AF-ON>** or tapping on the triangle on the screen top, bottom, left, or right.
- When you press the shutter button halfway, the normal view will return for **[FlexiZone - Multi]**. For **[FlexiZone - Single]**, AF will proceed with the magnified view.
- With Servo AF and magnified view, pressing the shutter button halfway will return to the normal view for focusing.

- If focusing is difficult in the magnified view, return to the normal view and perform AF.
- If you perform AF in the normal view and then the view is magnified, accurate focus may not be achieved.
- AF speed differs between normal view and magnified view.
- When in magnified view, Movie Servo AF (p.380) will not work.
- During magnified view, achieving focus becomes more difficult due to camera shake. Using a tripod is recommended.

# Shooting with the Touch Shutter

Just by tapping on the LCD monitor screen, you can focus and take the picture automatically.





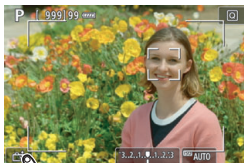

## 1 Display the Live View image.

- Press the < START/STOP > button.
- ▶ The Live View image will appear on the LCD monitor.



## 2 Enable the touch shutter.

- Tap [>] on the screen's bottom left. Each time you tap on the icon, it will toggle between [>] and [>].
- [>] (Touch shutter: Enable)  
The camera will focus on the spot you tap on, then the picture will be taken.
- [>] (Touch shutter: Disable)  
You can tap on a spot to perform focusing on the spot. Press the shutter button completely to take the picture.



## 3 Tap on the screen to shoot.

- Tap on the face or subject on the screen.
- ▶ On the point you tap, the camera will focus (Touch AF) with the AF method that was set (p.316-322).
- ▶ When [>] is set, the AF point turns green when focus is achieved, then the picture is taken automatically.
- ▶ If focus is not achieved, the AF point turns orange and the picture cannot be taken. Tap on the face or subject on the screen again.

- Even if you set the drive mode to <img alt="Single Shot icon" data-bbox="105 105 125 125"/> or <img alt="Single Shot icon" data-bbox="105 135 125 155"/>, the camera will still shoot in single shooting mode.
- Even if [AF operation] is set to [Server AF], tapping on the screen will focus on the image with [One-Shot AF].
- Tapping on the screen in magnified view will not focus or take the picture.
- In the <img alt="AF+ icon" data-bbox="105 215 125 235"/> mode, if [FlexiZone - Multi] or [Touch shutter: Disable] is set, focusing cannot be performed by tapping on the screen.
- If you shoot by tapping on the screen with [1: Image review] set to [Hold], you can press the shutter button halfway to take the next shot. Note that under [3: Custom Controls], if [Shutter butt. half-press] is set to [Metering start] or [AE lock (while button pressed)], the picture will be taken without performing AF.
- If you use [3: Custom Controls] to assign a button with [ONE SHOT ↔ AI SERVO/SERVO] or the function that activates the metering timer (p.495), touch shutter shooting cannot be performed when you hold down the respective button.

- You can also set the touch shutter with [5: Touch Shutter] (the [3] tab in <img alt="AF+ icon" data-bbox="105 485 125 505"/> mode).
- To shoot with bulb exposure, tap on the screen twice. The first tap on the screen will start the bulb exposure. Tapping it again will stop the bulb exposure. Be careful not to shake the camera when tapping on the screen.



# MF: Focusing Manually

You can magnify the image and focus precisely with MF (manual focus).

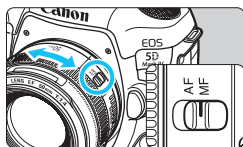

## 1 Set the lens's focus mode switch to <MF>.

- Turn the lens focusing ring to focus roughly.



## 2 Display the magnifying frame.

- Press the <Q> button or tap on [Q] on the lower right of the screen.
- ▶ The magnifying frame will appear.

Magnifying frame

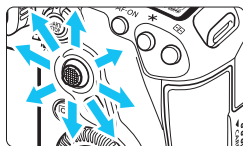

## 3 Move the magnifying frame.

- Either operate <⊗> or tap on the spot you want to magnify to move the magnifying frame to where you want to focus.
- Pressing <⊗> or <SET> will return the magnifying frame to the screen center.



## 4 Magnify the image.

- Each time you press the <Q> button or tap on [Q] on the lower right of the screen, the display will change in the following sequence:

▶ Normal view → 1x → 5x → 10x

- While in magnified view, you can operate <⊗> or tap on the triangle displayed on the top, bottom, left, or right of the screen to scroll around the magnified image.

AE lock

Magnified area position

Magnification (Approx.)

## 5 Focus manually.

- While looking at the magnified image, turn the lens focusing ring to focus.
- After achieving focus, press the <Q> button to return to the normal view.

## 6 Take the picture.

- Check the exposure, then press the shutter button completely to take the picture (p.298).



- In magnified view, the exposure is locked. (Shutter speed and aperture will be displayed in red.)
- Even with manual focusing, you can use the touch shutter to take a picture.



## General Live View Shooting Cautions

### Image Quality

- When you shoot at high ISO speeds, noise (such as dots of light and banding) may become noticeable.
- Shooting in high temperatures may cause noise and irregular colors in the image.
- If Live View shooting is used continuously for a prolonged period, the camera's internal temperature may rise, and image quality may deteriorate. Always exit Live View shooting when you are not shooting.
- If you shoot a long exposure while the camera's internal temperature is high, image quality may deteriorate. Exit Live View shooting and wait a few minutes before shooting again.

### White <[Icon]> and Red <[Icon]> Internal Temperature Warning Icons

- If the camera's internal temperature increases due to prolonged Live View shooting or under a high ambient temperature, a white <[Icon]> or red <[Icon]> icon will appear.
- The white <[Icon]> icon indicates that the image quality of still photos will deteriorate. It is recommended that you temporarily exit Live View shooting and allow the camera to cool down before shooting again.
- The red <[Icon]> icon indicates that the Live View shooting will soon stop automatically. If this happens, you will not be able to shoot again until the camera's internal temperature decreases. Exit the Live View shooting or turn off the power and let the camera rest for a while.
- Using Live View shooting at a high temperature for a prolonged period will cause the <[Icon]> or <[Icon]> icon to appear earlier. When you are not shooting, always turn off the camera.
- If the camera's internal temperature is high, the quality of images shot with a high ISO speed or long exposure may deteriorate even before the white <[Icon]> icon is displayed.

### Shooting Results

- In magnified view, the shutter speed and aperture will be displayed in red. If you take the picture in magnified view, the exposure may not come out as desired. Return to the normal view before taking the picture.
- Even if you take the picture in magnified view, the image will be captured with the image area of the normal view.

## General Live View Shooting Cautions

### Live View Image

- Under low- or bright-light conditions, the Live View image may not reflect the brightness of the captured image.
- Even if a low ISO speed is set, noise may be noticeable in the displayed Live View image under low light. However, when you shoot, the image recorded will have less noise. (The image quality of the Live View image is different from that of the recorded image.)
- If the light source (illumination) within the image changes, the screen may flicker. If this happens, exit Live View shooting and resume Live View shooting under the actual light source.
- If you point the camera in a different direction, it may throw off the Live View image's correct brightness momentarily. Wait until the brightness level stabilizes before shooting.
- If there is a very bright light source in the image, the bright area may appear black on the LCD monitor. However, the actual captured image will correctly show the bright area.
- In low light, if you set the [**F2: LCD brightness**] to a bright setting, noise or irregular colors may appear in the Live View image. However, the noise or irregular colors will not be recorded in the captured image.
- When you magnify the image, the image sharpness may look more pronounced than in the actual image.

### Custom Functions

- During Live View shooting, certain Custom Functions will not work (certain settings become invalid). For details, see page 480.

### Lens and Flash

- If the attached lens has an Image Stabilizer and you set the Image Stabilizer (IS) switch to **<ON>**, the Image Stabilizer will operate at all times even if you do not press the shutter button halfway. The Image Stabilizer consumes battery power and may decrease the number of possible shots. When the Image Stabilizer is not necessary, such as when using a tripod, it is recommended that you set the IS switch to **<OFF>**.
- The focus preset function is possible for Live View shooting only when using a (super) telephoto lens equipped with the focus preset mode released in and after the second half of 2011.
- FE lock and modeling flash will not work if an external Speedlite is used.

# 9

## Shooting Movies



Movie shooting is enabled by setting the Live View shooting/Movie shooting switch to <  >.

- **Before shooting movies, see page 356 and make sure the card is able to record movies at the desired movie-recording quality setting.**
- If you handhold the camera and shoot movies, camera shake can cause blurred movies. Using a tripod is recommended in such cases.



### Full HD 1080

Full HD 1080 indicates compatibility with High-Definition featuring 1080 vertical pixels (scanning lines).



# Shooting Movies

## Autoexposure Shooting

When the shooting mode is set to  $\langle \text{A}^+ \rangle$ ,  $\langle \text{P} \rangle$ , or  $\langle \text{B} \rangle$ , autoexposure control will take effect to suit the scene's current brightness.

- 1 Set the Mode Dial to  $\langle \text{A}^+ \rangle$ ,  $\langle \text{P} \rangle$ , or  $\langle \text{B} \rangle$ .

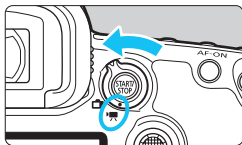

- 2 Set the Live View shooting/Movie shooting switch to  $\langle \text{Movie} \rangle$ .

▶ The Live View image will appear on the LCD monitor.

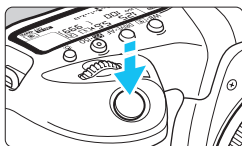

- 3 Focus on the subject.

- Before shooting a movie, focus with AF or manual focus (p.316, 329).
- When you press the shutter button halfway, the camera will focus with the current AF method.



- 4 Shooting the movie.

- Press the  $\langle \text{START/STOP} \rangle$  button to start shooting a movie.
- ▶ While the movie is being shot, the “●” mark will be displayed on the upper right of the screen.
- ▶ Sound will be recorded by the built-in microphone.
- To stop shooting the movie, press the  $\langle \text{START/STOP} \rangle$  button again.

Recording movies

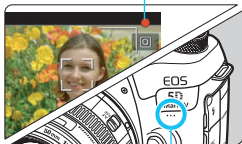

Built-in microphone

## Shutter-priority AE

When the shooting mode is <Tv>, you can manually set the shutter speed for movie shooting. The ISO speed and aperture will be set automatically to suit the brightness and obtain the standard exposure.



### 1 Set the Mode Dial to <Tv>.

### 2 Set the Live View shooting/Movie shooting switch to <Movie>.



Shutter speed

### 3 Set the desired shutter speed.

- While looking at the LCD monitor, turn the <Shutter Speed> dial.
- The settable shutter speeds depend on the frame rate. See page 343.



### 4 Focus and shoot the movie.

- The procedure is the same as steps 3 and 4 for “Autoexposure Shooting” (p.334).



- Changing the shutter speed during movie shooting is not recommended since the changes in the exposure will be recorded.
- When shooting a movie of a moving subject, a shutter speed of approx. 1/25 sec. to 1/125 sec. is recommended. The faster the shutter speed, the less smooth the subject's movement will look.
- The minimum shutter speed for shooting movies at a high frame rate will be 1/125 sec. for NTSC and 1/100 sec. for PAL.
- If you change the shutter speed while shooting under fluorescent or LED lighting, image flicker may be recorded.

## Av Aperture-priority AE

When the shooting mode is <Av>, you can manually set the aperture for movie shooting. The ISO speed and shutter speed will be set automatically to suit the brightness and obtain the standard exposure.



**1 Set the Mode Dial to <Av>.**

**2 Set the Live View shooting/Movie shooting switch to <Movie>.**



Aperture

**3 Set the desired aperture.**

- While looking at the LCD monitor, turn the <Aperture> dial.



**4 Focus and shoot the movie.**

- The procedure is the same as steps 3 and 4 for “Autoexposure Shooting” (p.334).

ⓘ Changing the aperture during movie shooting is not recommended since variations in the exposure, due to the drive of the lens aperture, will be recorded.



## ISO Speed in the <A+> Mode

### Full HD movie/ High frame rate movie shooting



- The ISO speed will be set automatically within ISO 100 - ISO 25600.

### 4K movie shooting



- The ISO speed will be set automatically within ISO 100 - ISO 12800.

## ISO Speed in the <P>, <Tv>, <Av>, and <B> Modes

### Full HD movie/ High frame rate movie shooting

- The ISO speed will be set automatically within ISO 100 - ISO 25600.
- In [Range for movies] under [ 2: ISO speed settings], if you set [Maximum] to [H2 (102400)] (p.379), the maximum limit of the automatic ISO speed setting range will be expanded to H2 (equivalent to ISO 102400). Note that even if you set the [Maximum] and [Minimum] to a narrower range than the default ISO range (ISO 100 - ISO 25600), it will not take effect.
- If [ 3: Highlight tone priority] is set to [Enable] (p.206), the automatic ISO speed setting range will be ISO 200 - ISO 25600.

### 4K movie shooting

- The ISO speed will be set automatically within ISO 100 - ISO 12800.
- Under [ 2: ISO speed settings], if you set [Range for  4K]'s [Maximum] setting to [H2 (102400)] (p.379), the maximum limit of the automatic ISO speed setting range will be expanded to H2 (equivalent to ISO 102400). Note that even if you set the [Maximum] and [Minimum] to a narrower range than the default ISO range (ISO 100 - ISO 12800), it will not take effect.
- If [ 3: Highlight tone priority] is set to [Enable] (p.206), the automatic ISO speed setting range will be ISO 200 - ISO 12800.



- For movie shooting, the ISO speed cannot be expanded to L (equivalent to ISO 50).
- When switching from still photo shooting to movie shooting, check the ISO speed settings again before shooting movies.



### Notes for <A+>, <P>, <Tv>, <Av>, and <B> Modes

- In the <A+> mode, the scene icon for the scene detected by the camera is displayed on the upper left of the screen (p.339).
- You can lock the exposure (AE lock) by pressing the <✳> button (except in the <A+> mode, p.259). After applying AE lock during movie shooting, you can cancel it by pressing the <☒> button. (AE lock setting is retained until you press the <☒> button.)
- You can set exposure compensation up to ±3 stops by setting the <LOCK▶> switch to the left and turning the <☉> dial (except in the <A+> mode).
- In the <A+>, <P>, and <B> modes, the ISO speed, shutter speed, and aperture will not be recorded in the movie's Exif information.
- During movie shooting in the <A+>, <P>, <Tv>, <Av>, or <B> modes, this camera supports the Speedlite's function to turn on the LED light automatically in low-light conditions. (However, no icon indicating that the LED light is ON is displayed on the information display screen illustrated on page 344.) For details, refer to the Instruction Manual of the EX-series Speedlite equipped with an LED light.

## Scene Icons

During movie shooting in the  $\langle \text{A}^+ \rangle$  mode, an icon representing the scene detected by the camera will be displayed, and the shooting will be performed to suit the scene.

Subject \ Background	Portrait <sup>*1</sup>	Non-Portrait		Background Color
		Nature and Outdoor Scene	Close <sup>*2</sup>	
Bright				Gray
	Backlit			
Blue Sky Included				Light blue
	Backlit			
Sunset	*3		*3	Orange
Spotlight				Dark blue
Dark				

\*1: Displayed only when the AF method is set to  $\langle \text{A}^+ \text{Tracking} \rangle$ . If another AF method is set, the “Non-portrait” icon will be displayed even if a person is detected.

\*2: Displayed when the attached lens has distance information. With an extension tube or close-up lens, the icon displayed may not match the actual scene.

\*3: The icon of the scene selected from the detectable scenes will be displayed.

For certain scenes or shooting conditions, the icon displayed may not match the actual scene.

## Manual Exposure Shooting

You can manually set the shutter speed, aperture, and ISO speed for movie shooting. Using manual exposure to shoot movies is for advanced users.



**1 Set the Mode Dial to <M>.**

**2 Set the Live View shooting/Movie shooting switch to <[Movie icon]>.**

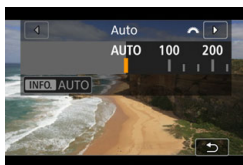

**3 Set the ISO speed.**

- Press the <[ISO icon]>•ISO> button.
- ▶ The ISO speed setting screen will appear on the LCD monitor.
- Turn the <[Gear icon]> dial to set it.
- For details on the ISO speed, see the next page.



Shutter speed

**4 Set the shutter speed and aperture.**

- Press the shutter button halfway and check the exposure level indicator.
- To set the shutter speed, turn the <[Gear icon]> dial. To set the aperture, turn the <[Aperture icon]> dial.
- The settable shutter speeds depend on the frame rate. See page 343.

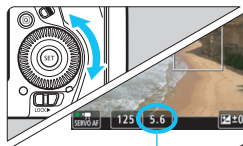



Aperture

**5 Focus and shoot the movie.**





- The procedure is the same as steps 3 and 4 for “Autoexposure Shooting” (p.334).

## ISO Speed in the <M> Mode

### Full HD movie/ High frame rate movie shooting

- With **[AUTO] (A)**, the ISO speed will be set automatically within ISO 100 - ISO 25600. In **[Range for movies]** under **[ 2: ISO speed settings]**, if you set **[Maximum]** to **[H2 (102400)]** (p.379), the maximum limit of automatic ISO speed setting range will be expanded to H2 (equivalent to ISO 102400). Note that even if you set the **[Maximum]** and **[Minimum]** to a narrower range than the default ISO range (ISO 100 - ISO 25600), it will not take effect.
- You can set the ISO speed manually within ISO 100 - ISO 25600 in 1/3-stop increments. If you set **[Maximum]** in **[Range for movies]** to **[H2 (102400)]**, the maximum limit of the manual ISO speed setting range will be expanded to H2 (equivalent to ISO 102400). Note that you can also set the **[Maximum]** and **[Minimum]** to a range narrower than the default range (ISO 100 - ISO 25600).
- If **[ 3: Highlight tone priority]** is set to **[Enable]** (p.206), automatic and manual setting range of ISO speed will be ISO 200 - ISO 25600.

### 4K movie shooting

- With **[AUTO] (A)**, the ISO speed will be set automatically within ISO 100 - ISO 12800. Under **[ 2: ISO speed settings]** in **[Range for  4K]**, if you set **[Maximum]** to **[H2 (102400)]** (p.379), the maximum limit of the automatic ISO speed setting range will be expanded to H2 (equivalent to ISO 102400). Note that even if you set the **[Maximum]** and **[Minimum]** to a narrower range than the default ISO range (ISO 100 - ISO 12800), it will not take effect.
- You can set the ISO speed manually within ISO 100 - ISO 12800 in 1/3-stop increments. If you set **[Maximum]** in **[Range for  4K]** to **[H2 (102400)]**, the maximum limit of the manual ISO speed setting range will be expanded to H2 (equivalent to ISO 102400). Note that you can also set the **[Maximum]** and **[Minimum]** to a range narrower than the default range (ISO 100 - ISO 12800).
- If **[ 3: Highlight tone priority]** is set to **[Enable]** (p.206), the automatic and manual ISO speed setting range will be ISO 200 - ISO 12800.

- 🔊 For movie shooting, the ISO speed cannot be expanded to L (equivalent to ISO 50).
- When switching from still photo shooting to movie shooting, check the ISO speed settings again before shooting movies.
- During movie shooting, avoid changing the shutter speed or aperture. Doing so may record the changes in the exposure or create more noise at high ISO speeds.
- When shooting a movie of a moving subject, a shutter speed of approx. 1/25 sec. to 1/125 sec. is recommended. The faster the shutter speed, the less smooth the subject's movement will look.
- The minimum shutter speed for shooting movies at a high frame rate will be 1/125 sec. for NTSC and 1/100 sec. for PAL.
- If you change the shutter speed while shooting under fluorescent or LED lighting, image flicker may be recorded.

- 📄 In step 4, if you cannot set the shutter speed or aperture, set the <LOCK▶> switch to the left and turn the <☀> or <🌀> dial.
- Under [**3: Custom Controls**], if [**Expo comp (hold btn, turn ☀)**] or [**Expo comp (hold btn, turn 🌀)**] is set (p.506), you can set exposure compensation while ISO Auto is set.
- When ISO Auto is set, you can press the <✖> button to lock the ISO speed. After locking the ISO speed during movie shooting, you can cancel it by pressing the <☑> button. (ISO speed lock is maintained until you press the <☑> button.)
- If you press the <✖> button and recompose the shot, you can see the exposure level difference on the exposure level indicator (p.344) compared to when the <✖> button was pressed.
- With the camera ready to shoot in the <M> mode, pressing the <INFO.> button displays the histogram.

## Settable Shutter Speeds

The settable shutter speeds in the <Tv> shutter-priority AE and <M> manual exposure shooting modes vary depending on the frame rate of the movie-recording quality.

(sec.)

Frame Rate	Shutter Speeds		
	Normal Movie Shooting	HDR Movie Shooting	
		<P> <Av> <B> <M> Modes	<Tv> Mode
119.9P	1/4000 - 1/125	-	
100.0P	1/4000 - 1/100		
59.94P	1/4000 - 1/60		
50.00P	1/4000 - 1/50		
29.97P	1/4000 - 1/30	1/1000 - 1/60*	1/4000 - 1/60
25.00P	1/4000 - 1/25	1/1000 - 1/50	1/4000 - 1/50
24.00P		-	
23.98P			

\* <P> <Av> <B>: 1/1000 - 1/100

## Still Photo Shooting

**Still photos cannot be taken during movie shooting.** To take still photos, stop the movie shooting and take still photos using viewfinder shooting or Live View shooting.

## Information Display

Each time you press the <INFO.> button, the information display will change.

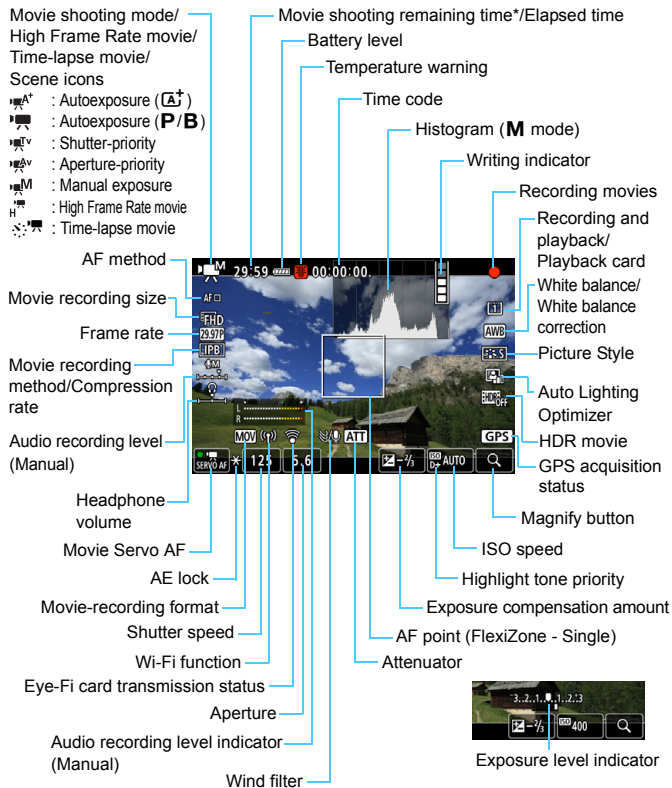

\* Applies to a single movie clip.

● The display will show only the settings currently applied.





- When the **[AF method]** is **[FlexiZone - Multi]** or **[FlexiZone - Single]**, you can press the **<INFO.>** button to display the electronic level (p.82).
- You can set what is displayed when you press the **<INFO.>** button (p.305).
- If **[AF method]** is set to **[L+Tracking]** or if the camera is connected to a TV set with an HDMI cable, the electronic level will not be displayed.
- The electronic level, grid lines, or histogram cannot be displayed during movie shooting. (The display will disappear when you start shooting a movie.)
- When movie shooting starts, the movie shooting remaining time will change to the elapsed time.

## ⚠️ Cautions for Movie Shooting

- Do not point the camera toward an intense light source, such as the sun or an intense artificial light source. Doing so may damage the image sensor or the camera's internal components.
- If you shoot something that has fine detail, moire or false colors may result.
- Under [**1**: **Record func+card/folder sel.**], even if [**Record func.**] is set to [**Rec. to multiple**] (p.167), the movie cannot be recorded to both the CF card [**1**] and SD card [**2**]. Note that if [**Rec. separately**] or [**Rec. to multiple**] is set, the movie will be recorded to the card set for [**Playback**].
- If <**AWB**> or <**AWB w**> is set and the ISO speed or aperture changes during movie shooting, the white balance may also change.
- If you shoot a movie under fluorescent or LED lighting, the movie image may flicker.
- If you perform AF with a USM lens during movie shooting in low light, horizontal banding noise may be recorded in the movie. The same type of noise may occur if you focus manually with certain lenses equipped with an electronic focusing ring.
- Shooting a few test movies is recommended if you intend to perform zooming during movie shooting. Zooming during movie shooting may result in recording of changes in exposure or mechanical sound of the lens, or images may be out of focus.
- During movie shooting, if you perform AF, any of the following may occur: The focus is temporarily greatly thrown off, changes in movie brightness is recorded, the movie recording stops momentarily, and the mechanical sound of the lens is recorded.
- During movie shooting, you cannot magnify the image even if you press the <**Q**> button.
- Be careful not to cover the built-in microphone (p.334) with your fingers, etc.
- If you connect or disconnect the HDMI cable during movie shooting, the movie shooting will end.

### Warnings

**Do not hold the camera in the same position for long periods of time.**



Even if the camera does not feel too hot, prolonged contact with the same body part may cause skin redness or blistering due to low-temperature contact burns. Using a tripod is recommended for people with circulation problems or very sensitive skin, or when using the camera in very hot places.



- “General Movie Shooting Cautions” are on pages 391-392.
- If necessary, also read “General Live View Shooting Cautions” on pages 331-332.



### Notes for Movie Shooting

- Under the [M4] and [M5] tabs (the [M2] and [M3] tabs in <A+> mode), you can set the movie shooting settings (p.380).
- Each time you shoot a movie, a new movie file is created on the card.
- The movie screen coverage for 4K, Full HD or HD movies is approx. 100%.
- You can also focus by pressing the <AF-ON> button.
- With [AF/AF-ON] or [AF/AF-ON] selected under [M5:  btn function], you can press the shutter button completely to start or stop the movie shooting (p.386).
- Monaural sound is recorded by the camera’s built-in microphone (p.334).
- Stereo sound recording (p.363) is also possible by connecting the Directional Stereo Microphone DM-E1 (sold separately) to the camera’s external microphone IN terminal (p.29) as the external microphone is given the priority.
- Most external microphones equipped with a 3.5 mm diameter mini plug can be used.
- With a fully-charged Battery Pack LP-E6N, the possible movie shooting time will be as follows: At room temperature (23°C/73°F), approx. 1 hr. 30 min., at low temperatures (0°C/32°F) approx. 1 hr. 20 min. (With [M4: Movie Servo AF: Disable] and  29.97P / 25.00P / 24.00P / 23.98P [IPB] set.)
- The focus preset function is possible for movie shooting when using a (super) telephoto lens equipped with the focus preset mode, released in and after the second half of 2011.

## Final Image Simulation

Final image simulation is a function that shows the movie as it will look with the current settings for Picture Style, white balance and other shooting functions applied.

During movie shooting, the image displayed will automatically show the effects of the settings listed below.

### Final Image Simulation for Movie Shooting

- Picture Style
  - \* Sharpness (Strength), contrast, color saturation, and color tone will be reflected.
- White balance
- White balance correction
- Exposure
- Depth of field (except during time-lapse movie shooting)
- Auto Lighting Optimizer
- Peripheral illumination correction
- Chromatic aberration correction
- Highlight tone priority
- HDR movie

# Shooting Function Settings

## WB/ISO/☞☞ Settings

If you press the <WB•☉>, <ISO•ISO>, or <☞> button with the image displayed on the LCD monitor, the setting screen will appear on the LCD monitor and you can turn the <☞> or <☞> dial to set the respective function.

- During manual-exposure shooting (p.340), you can press the <ISO•ISO> button to set the ISO speed.
- By pressing the <WB•☉> button and then the <INFO.> button, you can set white balance shift.
- You cannot set the AF operation, drive mode, metering mode, flash exposure compensation, HDR mode, or multiple exposures.

## Q Quick Control

In the <P>, <Tv>, <Av>, <M>, and <B> modes, **AF method**, **Movie recording size**, Recording level (manual setting only), **Sound volume** (headphones), **Card selection**, White balance, Picture Style, Auto Lighting Optimizer, and **HDR movie shooting** can be set. In the <A+> mode, only the functions in bold above can be set.



### 1 Press the <Q> button (10).

- ▶ The settable functions will be displayed.

### 2 Select a function and set it.

- Use <⊕> to select a function.
- ▶ The setting of the selected function is displayed on the screen.
- Turn the <☀> or <⊙> dial to set it.
- To set the white balance shift or Picture Style parameters, press the <INFO.> button.
- To set Auto white balance, select [AWB], then press <⊙>.
- To return to movie shooting, press <⊙> or the <Q> button.

- When [High Frame Rate] is set to [Enable] under [4: Movie rec quality], the sound-recording level option will not be displayed. Also, the movie-recording size cannot be set.
- With [5: Time-lapse movie] set to [Enable], if you press the <Q> button, the recording-level will not be displayed.

During movie shooting, you can press the <Q> button to set the sound-recording level (manual setting only) and sound volume (headphones).

## MENU Setting the Movie Recording Quality

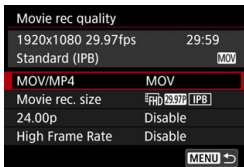

With [**4**: **Movie rec quality**] (or the [**2**] tab in the <[A]<sup>+</sup>> mode), you can set the movie recording format, movie recording size (size, frame rate, video format/compression method), and other functions.

The frame rate displayed on the [**Movie rec. size**] screen switches automatically depending on the [**3**: **Video system**] setting (p.549).

**!** The card's writing and reading speeds required for recording movies vary depending on the movie-recording quality. Before shooting movies, see page 356 to check the performance requirements of the card.

### MOV/MP4

You can select the movie's recording format.

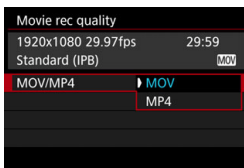

#### MOV MOV

The movie will be recorded in the MOV format (file extension “.MOV”). Convenient for editing with a computer.

#### MP4 MP4

The movie will be recorded in the MP4 format (file extension “.MP4”). This file format is compatible with a much larger range of playback systems than with MOV files.

**!** When [**MP4**] is set, [**High Frame Rate**] cannot be set.

## Movie Recording Size

You can select the movie's size, frame rate, and compression method.



- **Image Size**

- **4K 4096x2160**

The movie will be recorded in 4K quality. The aspect ratio is approx.

17:9. To shoot **4K 29.97P 25.00P /**

**23.98P MJPG** movies, use a high-speed CF card supporting UDMA 7 (p.356).

- **FHD 1920x1080**

The movie will be recorded in Full High-Definition (Full HD) quality. The aspect ratio is 16:9.

- **HD 1280x720**

High Frame Rate movies (p.358) will be recorded in high-definition (HD) quality. The aspect ratio is 16:9.

- **Frame Rate** (fps:frame per second)

- **119.9P 119.9fps / 59.94P 59.94fps / 29.97P 29.97fps**

For areas where the TV system is NTSC (North America, Japan, South Korea, Mexico, etc.). For **119.9P**, see page 358.

- **100.0P 100.0fps / 50.00P 50.00fps / 25.00P 25.00fps**

For areas where the TV system is PAL (Europe, Russia, China, Australia, etc.). For **100.0P**, see page 358.

- **23.98P 23.98fps / 24.00P 24.00fps**

Mainly for motion pictures. For **24.00P**, see page 357.

 **23.98P** (23.98fps) can be selected when [**3: Video system**] is set to [**For NTSC**].



## ● 4K movie shooting

- Shooting 4K movies requires a high-performance card. For details on card requirements for movie shooting, see “Cards that Can Record Movies” on page 356.
- Shooting 4K movies or High Frame Rate movies greatly increases the processing load. Compared with normal movie shooting, the camera’s internal temperature may increase faster or may become higher. If the red  icon appears during movie shooting, it indicates that the card may be hot. Stop the movie shooting and let the camera cool down before removing the card. (Do not remove the card right away.)
- From a 4K movie, you can select any desired frame to save it as an approx. 8.8 megapixel (4096x2160) JPEG still image to the card (p.427).



To obtain better performance with the card, formatting the card with the camera before shooting movies is recommended (p.73).

## ● Movie-recording coverage

The respective area of the image sensor shown below is used for 4K movies and Full HD and HD movies.



- For 4K movie shooting, [**3: High ISO speed NR**] will not take effect. Therefore, noise may be more noticeable depending on the shooting conditions.
- If you change the [**3: Video system**] setting, also set the movie-recording size again.
- Movies shot in 4K, **FHD 59.94P / 50.00P**, or at a high frame rate may not be played back properly on other devices due to the heavy data processing load during playback.

- The frame rate displayed on the movie recording size screen switches depending on whether [**3: Video system**] is set to [**For NTSC**] or [**For PAL**].
- You cannot shoot Standard Definition (VGA) movies.
- If you change the movie size from Full HD or HD to 4K, the image area of the movie shooting will be shifted to the telephoto end.
- The 4K movie coverage is different from that of the EOS-1D C and EOS-1D X Mark II.
- The color sampling recorded will be as follows: 4K: YCbCr 4:2:2 (8-bit), Full HD/HD: YCbCr 4:2:0 (8-bit). The color matrix will be as follows: 4K: Rec. ITU-R BT.601, and Full HD/HD: Rec. ITU-R BT.709.

- **Movie recording method/Compression rate**

**MJPG**

Selectable when the movie recording format is **[MOV]**. Motion JPEG is used to compress the movie for recording. Without any compression between frames, each frame is compressed at a time and recorded. The compression rate is therefore low. Also, since the image size is large with 4K quality, the file size will be large.

**[ALL-I]** **ALL-I** (For editing/I-only)

Selectable when the movie recording format is **[MOV]**. Compresses each frame at a time for recording. Although the file size is larger than with IPB (Standard), the movie is better suited in editing.

**[IPB]** **IPB** (Standard)

Compresses multiple frames at a time efficiently for recording. Since the file size is smaller than with ALL-I (For editing), movie shooting time will be longer (with a card of the same capacity).

**[IPB]** **IPB** (Light)

Selectable when the movie recording format is **[MP4]**. Since the movie is recorded at a bit rate lower than with IPB (Standard), the file size will be smaller than with IPB (Standard) and the playback compatibility will be higher. Of the four movie-recording methods, this one provides the longest possible shooting time (with a card of the same capacity).

## Cards that Can Record Movies

When shooting movies, use a large-capacity card with a reading/writing speed (required card performance) shown in the table or higher than the standard specification. Test the card by taking a few movies in the desired quality (p.351) and make sure the card can properly record the movie.

Movie Recording Quality			CF Card	SD card
4K	29.97P 25.00P 24.00P 23.98P	MJPG	UDMA 7 100 MB/sec. or faster	UHS-I 90 MB/sec. or faster
	59.94P 50.00P	ALL-I	UDMA 7 60 MB/sec. or faster	UHS-I Speed Class 3 or higher
FHD	59.94P 50.00P	IPB	30 MB/sec. or faster	SD Speed Class 10 or higher
	29.97P 25.00P 24.00P 23.98P	ALL-I	30 MB/sec. or faster	UHS-I Speed Class 3 or higher
	29.97P 25.00P 24.00P 23.98P HDR movies	IPB	10 MB/sec. or faster	SD Speed Class 6 or higher
	29.97P 25.00P	IPB	10 MB/sec. or faster	SD Speed Class 4 or higher
HD	119.9P 100.0P	ALL-I	UDMA 7 60 MB/sec. or faster	UHS-I Speed Class 3 or higher

- Before shooting 4K movies, format the card (p.73).
- If you use a slow-writing card when shooting movies, the movie may not be recorded properly. Also, if you play back a movie on a card with a slow reading speed, the movie may not be played back properly.
- For bit rates, see page 580. When shooting movies, use a high performance card with the writing speed well exceeding the bit rate.
- When movies cannot be recorded normally, format the card and try again. If formatting the card does not resolve the problem, refer to the card manufacturer's Web site.

- The camera is not compatible with UHS-II SDHC/SDXC cards. (Compatible with UHS-I.) With a UHS-II SDHC/SDXC card, high-speed transfer via UHS-I may not be possible, depending on the card specification.



- To optimize the use of the card, formatting the card with the camera before shooting movies is recommended (p.73).
- To check the card's reading/writing speed, refer to the card manufacturer's Web site.

## 24.00p

Records the movie at a frame rate of 24.00 fps.

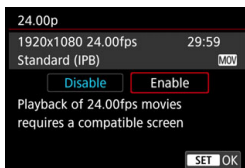

When **[Enable]** is set, you can select the movie-recording quality as follows:

**[4K 24.00P]** **[MJPG]**, **[FHD 24.00P]** **[ALL-I]**, or **[FHD 24.00P]** **[IPB]**.

If you have set **[Movie rec. size]** and then set **[24.00p]** to **[Enable]**, set the **[Movie rec. size]** again.



### Cautions for [24.00p: Enable]

- When **[MP4]** is set, **[Movie rec. size]** cannot be set. **[FHD 24.00P]** **[IPB]** will be set.
- [High Frame Rate]** (p.358) cannot be set.
- [4:3: Video system]** cannot be set.
- [4: HDMI frame rate]** (p.390) cannot be set. The movie image will be output at 1080/24.00p via HDMI. If you connect the camera to a TV set etc. not compatible with the 1080/24.00p signal via HDMI, the movie image may not be displayed.
- If you set it back to **[Disable]**, **[4: HDMI frame rate]** will be set to **[Auto]**.
- Even if you set it back to **[Disable]**, the movie recording size will not revert to the original setting. Set the movie recording size again.

## High Frame Rate

At HD quality, you can shoot movies at a high frame rate of 119.9 fps or 100.0 fps. Good for shooting movies to be played back in slow motion. The maximum recording time of one movie clip is 7 min. 29 sec.

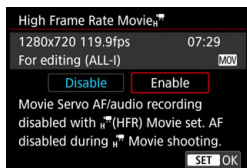

The movie will be recorded as **HD 119.9P ALL-I MOV** or **HD 100.0P ALL-I MOV**.

Movie Servo AF will not work for high frame rate movie shooting. Also, during high frame rate movie shooting, AF will not work.

High Frame Rate movies do not record sound.

If the time code is displayed during movie shooting, it will count up 4 sec. for each sec. in real time.

Since the High Frame Rate movie will be recorded as a 29.97 fps/25.00 fps movie file, it will be played back in slow motion at 1/4 speed.

### ⚠ Cautions for [High Frame Rate: Enable]

- When [Count up] is set to [Free run] under [5: Time code] (p.365), the time code will not be recorded.
- [MOV/MP4], [Movie rec. size], and [24.00p] cannot be set.
- Even if you set it back to [Disable], the movie recording size will not revert to the original setting. Set the movie recording size again.
- If you shoot a High Frame Rate movie under fluorescent or LED lighting, the movie image may flicker.
- When you start or stop High Frame Rate movie shooting, the movie image will not be updated temporarily (frame stops momentarily). Be aware of this when using an external recording device to record the movie from the HDMI video output.
- During the High Frame Rate movie shooting, the frame rate of the movie image displayed on the LCD monitor is different from the frame rate of the movie image being recorded.
- Headphones cannot be used. (You cannot listen to the sound.)

## Total Movie Recording Time and File Size Per Minute

### ● In MOV Format

(Approx.)

Movie Recording Quality	Total Possible Recording Time on Card			File Size
	8 GB	32 GB	128 GB	
<b>4K : 4K</b>				
29.97P 25.00P 24.00P 23.98P [MJPEG]	2 min.	8 min.	34 min.	3587 MB/min.
<b>FHD : Full HD</b>				
59.94P 50.00P [ALL-I]	5 min.	23 min.	94 min.	1298 MB/min.
59.94P 50.00P [IPB]	17 min.	69 min.	277 min.	440 MB/min.
29.97P 25.00P 24.00P 23.98P [ALL-I]	11 min.	46 min.	186 min.	654 MB/min.
29.97P 25.00P 24.00P 23.98P [IPB]	33 min.	135 min.	541 min.	225 MB/min.
HDR movie shooting	33 min.	135 min.	541 min.	225 MB/min.
<b>FHD : HD</b>				
119.9P 100.0P [ALL-I]	6 min.	26 min.	105 min.	1155 MB/min.

### ● In MP4 Format

(Approx.)

Movie Recording Quality	Total Possible Recording Time on Card			File Size
	8 GB	32 GB	128 GB	
<b>FHD : Full HD</b>				
59.94P 50.00P [IPB]	17 min.	70 min.	283 min.	431 MB/min.
29.97P 25.00P 24.00P 23.98P [IPB]	35 min.	140 min.	563 min.	216 MB/min.
HDR movie shooting	35 min.	140 min.	563 min.	216 MB/min.
29.97P 25.00P [IPB]	86 min.	347 min.	1391 min.	87 MB/min.



An increase of the camera's internal temperature may cause movie shooting to stop before the total recording time shown in the table (p.391).

- **Movie Files Exceeding 4 GB**

Even if you shoot a movie exceeding 4 GB, you can keep shooting without interruption.

- **Using CF cards up to 128 GB and SD/SDHC cards formatted with the camera**

If you use the camera to format a CF card with 128 GB or less in capacity or an SD/SDHC card, the camera will format it in FAT32. With a FAT32-formatted card, if you shoot a movie and the file size exceeds 4 GB, a new movie file will be created automatically.

When you play back the movie, you will have to play each movie file individually. Movie files cannot be played back automatically in consecutive order. After the movie playback ends, select the next movie and play it back.

- **Using CF cards exceeding 128 GB and SDXC cards formatted with the camera**

If you use the camera to format a CF card with more than 128 GB in capacity or an SDXC card, the camera will format it in exFAT.

When using an exFAT-formatted card, even if the file size exceeds 4 GB during movie shooting, the movie will be saved as a single file (rather than being split into multiple files).





- When downloading movie files exceeding 4GB to a computer, use either the EOS Utility (p.596) or a card reader (p.597). Movie files exceeding 4GB will not be downloaded if you perform image download with the function of a computer (OS).
- Deleting any of the movie files created as a movie shot at one time exceeding 4GB will make it impossible for EOS MOVIE Utility (p.599) to play back the movie files consecutively or to merge and save them as a single movie file.



Using EOS MOVIE Utility, you can automatically merge multiple MOV format movie files split at 4 GB each and save them as a single movie file.

## ● Movie Shooting Time Limit

### ● When shooting movies other than High Frame Rate movies

The maximum recording time of one movie clip is 29 min. 59 sec. If the movie shooting time reaches 29 min. 59 sec., the movie shooting will stop automatically. You can start shooting a movie again by pressing the <  > button. (The movie will be recorded as a new movie file.)

### ● When shooting High Frame Rate movies

The maximum recording time of one movie clip is 7 min. 29 sec. If the movie shooting time reaches 7 min. 29 sec., the movie shooting will stop automatically. You can start shooting a High Frame Rate movie again by pressing the <  > button. (The movie will be recorded as a new movie file.)

## MENU Setting the Sound Recording

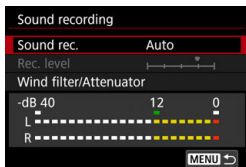

You can shoot movies while recording sound with the built-in monaural microphone or an external stereo microphone. You can also freely adjust the sound-recording level.

Set the sound recording with [**4**: **Sound recording**] (the [**2**] tab in <[**A**> mode).

### Sound Recording/Sound Recording Level

- Auto** : The sound-recording level is adjusted automatically. Auto level control will operate automatically in response to the sound level.
- Manual** : For advanced users. You can adjust the sound-recording level to one of 64 levels.  
Select [**Rec. level**] and turn the <[**0**> dial while looking at the level meter to adjust the sound-recording level. Look at the peak hold indicator, and adjust so that the level meter sometimes lights up on the right of the “12” (-12 dB) mark for the loudest sounds. If it exceeds “0”, the sound will be distorted.
- Disable** : Sound will not be recorded. Also, sound will not be output for the HDMI output (p.387).

 High Frame Rate movies do not record sound. Also, [**4**: **Sound recording**] cannot be set.

## Wind Filter/Attenuator

- Wind filter** : When **[Enable]** is set, it reduces the wind noise when recording outdoors. This feature works only when you use the built-in microphone for movie shooting. Note that **[Enable]** reduces low bass sounds, so set it to **[Disable]** when there is no wind. It will record a more natural sound than with **[Enable]**.
- Attenuator** : Automatically suppresses sound distortion caused by loud noises. Even if **[Sound rec.]** is set to **[Auto]** or **[Manual]** for shooting, sound distortion may still result if there is a very loud sound. In such a case, setting it to **[Enable]** is recommended.

### ● Using a microphone

Normally, the built-in microphone records monaural sound. Stereo sound recording is possible by connecting an external stereo microphone equipped with a miniature stereo plug (3.5 mm diameter) to the camera's external microphone IN terminal (p.29) as the external microphone is given the priority. Using the Directional Stereo Microphone DM-E1 (sold separately) is recommended.

### ● Using headphones

By connecting headphones (commercially-available) equipped with a 3.5 mm diameter mini plug to the camera's headphone terminal (p.29), you can listen to the sound during movie shooting. If you are using an external stereo microphone, you can listen to the sound in stereo. To adjust the headphones' sound volume, press the **<Q>** button and select **<Q>**. Then turn **<◉>** to adjust the volume (p.350).

You can also use headphones during movie playback.

-  ● If you use the Wi-Fi (wireless communication) function with an external microphone, the sound noise may be recorded. During sound recording, using the wireless communication function is not recommended.
- When connecting an external microphone or headphones to the camera, be sure to insert the plug all the way in.
- The camera's built-in microphone will also record the operation sound and mechanical sound of the camera during shooting. Use the Directional Stereo Microphone DM-E1 (sold separately) to reduce these sounds in the movie.
- Do not connect anything other than an external microphone to the camera's external microphone IN terminal.
- When using headphones for audio, noise reduction will not be applied to the headphone output. Because of this, what you hear will differ from the actual audio recorded with the movie.
- When listening to the sound with headphones, do not change the **[Sound recording]** settings. Doing so may cause a sudden increase in the sound level and hurt your ears.

-  ● In the <[A+]> mode, **[Sound recording]** can be set to **[On]** or **[Off]**. If **[On]** is set, the sound-recording level will be adjusted automatically (same as with **[Auto]**), but the wind filter function will not take effect.
- When the camera is connected to a TV set with an HDMI cable, the sound will also be output (except when **[Sound rec.: Disable]** is set).
- The sound volume balance between L (left) and R (right) cannot be adjusted.
- Audio is recorded at a 48 kHz/16-bit sampling rate.

## MENU Setting the Time Code

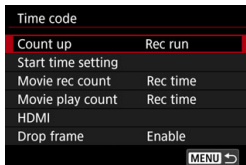

The time code is a time reference recorded automatically to synchronize the movie during movie shooting. It is recorded at all times in the following units: hours, minutes, seconds, and frames. It is mainly used during movie editing.

Use [**5: Time code**] (the [**3**] tab in <[A+]> mode) to set the time code.

### Count Up

- Rec run** : The time code counts up only while you are shooting a movie. The time code will continue in the sequence of the movie files captured.
- Free run** : The time code counts up whether you are shooting a movie or not.

### Start Time Setting

You can set the time code's initial point (start time).

**Manual input setting**: You can freely set the hour, minute, second, and frames.

**Reset** : The time set with [**Manual input setting**] and [**Set to camera time**] is reset to "00:00:00." or "00:00:00." (p.368).

**Set to camera time** : Sets hours, minutes, and seconds to match the camera's internal clock. "Frames" will be set to "00".

- ❗ If you shoot a High Frame Rate movie with [**Free run**] set, the time code will not be appended.
- If [**Free run**] is set and you change the time, zone, or daylight saving time (p.51), the time code will be affected.
- If you play back an MP4 movie with a device other than the camera, the time code may not be displayed properly.

## Movie Recording Count

You can select what to display on the movie shooting screen.

**Rec time** : Displays the elapsed time from the start of the movie shooting.

**Time code** : Displays the time code during movie shooting.

## Movie Playback Count

You can select what to display on the movie playback screen.

**Rec time** : Displays the recording time and playback time during movie playback.

**Time code** : Displays the time code during movie playback.

With [Time code] set:



During movie shooting



During movie playback

- Regardless of the [Movie rec count] setting, the time code will always be recorded to the movie file (except for High Frame Rate movies with [Free run] set).
- The [Movie play count] setting under [CAM5: Time code] switches in tandem with the [CAM3: Movie play count] setting. Changing either setting will automatically change the other.
- “Frames” are not displayed for movie shooting or during movie playback.

## HDMI

- **Time code**

The time code can be appended to a movie that is output via HDMI.

**Enable:** Appends time code to HDMI video output. When [**Enable**] is set, [**Rec Command**] will be displayed.

**Disable:** Time code not appended to HDMI video output.

- **Record command**

When a video output via HDMI is recorded by an external recording device, the camera's movie shooting start and stop can sync with the recording by an external recording device.

**Enable:** The movie shooting start and stop sync with the recording by an external recording device.

**Disable:** The recording start and stop are controlled by the external recording device.



- During High Frame Rate movie shooting, when outputting a movie via HDMI with [**Count up**] in [**Time code**] set to [**Free run**], the time code will not be appended to the HDMI video output.
- To check whether your external recording device is compatible with the [**Time code**] or [**Rec Command**], consult the manufacturer of the external recording device.
- Even if you set [**Time code**] to [**Disable**], time code may be appended to the movie depending on the specifications of the external recording device. For specifications of time code for HDMI input, consult the manufacturer of the external recording device.

## Drop Frame

If the frame rate is set to **119.9P** (119.9 fps), **59.94P** (59.94 fps), or **29.97P** (29.97 fps), the time code's frame count causes a discrepancy between the actual time and time code. When [**Enable**] is set, this discrepancy is corrected automatically. This correction function is called "drop frame." This is for advanced users editing movies.

**Enable** : The discrepancy is corrected automatically by skipping time code numbers (DF: Drop frame).

**Disable** : The discrepancy is not corrected (NDF: Non-drop frame).

The time code will be displayed as follows:

Enable (DF) : 00:00:00. (Playback time: 00:00:00.00)

Disable (NDF) : 00:00:00. (Playback time: 00:00:00.00)

 If the frame rate is **100.0P** (100.0 fps), **50.00P** (50.00 fps), **25.00P** (25.00 fps), **24.00P** (24.00 fps), or **23.98P** (23.98 fps), the drop frame will not work. (If **100.0P** / **50.00P** / **25.00P** / **24.00P** / **23.98P** is set or if [**3: Video system**] is set to [**For PAL**], [**Drop frame**] will not be displayed.)



# Shooting HDR Movies

You can shoot movies with clipped highlights reduced for a high dynamic range of tones even in high-contrast scenes.

**You can set the HDR movie with the Quick Control screen if [Movie rec. size] is set to  $\overline{\text{FHD 29.97P}} \overline{\text{IPB}}$  (NTSC) or  $\overline{\text{FHD 25.00P}} \overline{\text{IPB}}$  (PAL) under [CAMERA 4: Movie recording quality].** HDR movie shooting is possible either when the movie-recording format is set to MOV or MP4.

## 1 Check [Movie rec. size].

- Check that [Movie rec. size] under [CAMERA 4: Movie recording quality] is set to  $\overline{\text{FHD 29.97P}} \overline{\text{IPB}}$  or  $\overline{\text{FHD 25.00P}} \overline{\text{IPB}}$ .



## 2 Press the <Q> button (10).

- ▶ The Quick Control screen will appear.



## 3 Select [HDR Off].

- Tilt <DISP> up or down to select [HDR Off] (HDR Movie Shooting) displayed on the lower right of the screen.

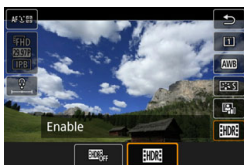

## 4 Select [HDR] (Enable).

- Turn the <DISP> dial to select [HDR] (Enable).
- For recording time and file sizes, see the table on page 359.

## 5 Shoot an HDR movie.

- Shoot the movie in the same way as normal movie shooting.

- For HDR movie shooting, the ISO speed auto and manual setting ranges are ISO 100 - ISO 25600. Expanded ISO speeds cannot be set.
- For the shutter speeds, see page 343.
- In the <Tv> mode, the minimum ISO speed will be ISO 400.
- If [**3: Highlight tone priority**] is set to [**Enable**], HDR movie shooting cannot be set.
- With HDR movie shooting, the image may still flicker even when an appropriate shutter speed has been set.
- Since multiple frames are merged to create an HDR movie, certain parts of the movie may look distorted. During handheld shooting, camera shake may make the distortion look more noticeable. Using a tripod is recommended. Note that even if a tripod is used for shooting, afterimages or noise may become more noticeable when the HDR movie is played back frame-by-frame or in slow-motion compared to normal playback.
- If [**5: Time-lapse movie**] is set to [**Enable**], HDR movie shooting will not be possible.
- If you change the HDR movie shooting setting, the color and brightness of the image may drastically change for a moment. Also, the movie image will not be updated temporarily (frame stops momentarily). Be aware of this when using an external recording device to record the HDMI video output.

# Shooting Time-lapse Movies

Still photos shot at a set interval can be stitched together automatically to create a time-lapse movie. A time-lapse movie shows how a subject changes in a much shorter period of time than the actual time it took. It is effective for a fixed-point observation of changing scenery, growing plants, celestial motion, etc.

Time-lapse movies are recorded in MOV,  $\overline{\text{FHD}}$  29.97P  $\overline{\text{ALL-I}}$  (NTSC) or  $\overline{\text{FHD}}$  25.00P  $\overline{\text{ALL-I}}$  (PAL). The frame rate will be switched automatically according to the [**F3: Video system**] setting (p.549).

## 1 Select the shooting mode.

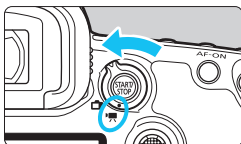

## 2 Set the Live View shooting/Movie shooting switch to <Movie>.

- ▶ The Live View image will appear on the LCD monitor.

## 3 Select [Time-lapse movie].

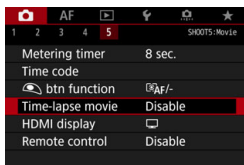

- Under the [**5**] tab (the [**3**] tab in <A+> mode), select [**Time-lapse movie**], then press <SET>.
- If the [**Only available when movie shooting is activated**] message appears, press the <START/STOP> button, then repeat step 3.

## 4 Select [Enable].



- Select [**Enable**], then press the <INFO.> button.

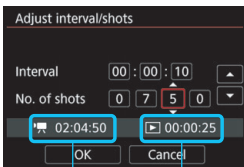

Time required Playback time

## 5 Set the shooting interval and number of shots.

- Check the [📽️: Time required] and [▶️: Playback time] displayed at the bottom of the screen to set the shooting interval and number of shots.
- Select the number to be set (hours: minutes: seconds / number of shots).
- Press <SET> so <⏏> is displayed.
- Set the desired number, then press <SET> (Returns to <□>).

### • Shooting Interval

Settable from [00:00:01] to [99:59:59].

### • Number of shots

Settable from [0002] to [3600]. Set one digit at a time. If 3600 is set, the time-lapse movie will be approx. 2 min. for NTSC and approx. 2 min. 24 sec. for PAL.

## 6 Select [OK].

- ▶ The screen in step 3 will reappear.

## 7 Check the settings.

- With [Time-lapse movie] selected on the screen in step 3, press <SET>.
- ▶ The current settings will be displayed.



- **Time required**

Indicates the time required to shoot the set number of shots with the set interval. If it exceeds 24 hours, “\*\*\* days” will be displayed.

- **Playback time**

Indicates the movie recording time (time required to play back the movie) to create the time-lapse movie in **FHD 29.97P [ALL-I]** (NTSC) or **FHD 25.00P [ALL-I]** (PAL) from the still photos taken with the set intervals.

- **Card- time left**

The total time available for recording time-lapse movies on the card based on its remaining capacity.

## 8 Exit the menu.

- Press the <MENU> button to turn off the menu screen.

## 9 Read the message.

- Read the message and select [OK].

## 10 Take test shots.

- Set the exposure and shooting functions, and press the shutter button halfway to focus as you do with Live View shooting.
- Press the shutter button completely to start taking test shots. The test images will be recorded to the card.
- If there are no problems with the test shots, go to the next step.
- To take test shots again, repeat this step.

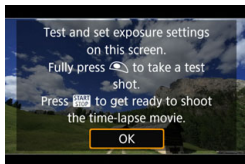



## 11 Press the <START/STOP> button.

- ▶ The camera will be ready to start shooting a time-lapse movie.
- To return to step 9, press the <START/STOP> button again.

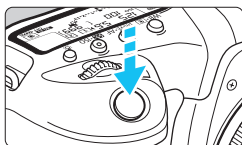

## 12 Shoot the time-lapse movie.

- Press the shutter button halfway to check the focus and exposure.
- Press the shutter button completely to start shooting the time-lapse movie.
- AF will not work during time-lapse movie shooting. The exposure setting for the first shot will be applied to subsequent shots.
- During time-lapse movie shooting, nothing will be displayed on the LCD monitor. <☼> will blink on the LCD panel.
- Since the electronic shutter is used for shooting, the reflex mirror and shutter make no mechanical sound during time-lapse movie shooting.
- When the set number of shots are taken, the time-lapse movie shooting will stop and be automatically canceled.

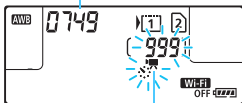

Shots remaining



Time-lapse movie



- Using a tripod is recommended.
- Taking test shots in advance is recommended.
- Regardless of the [**4: Movie recording quality**] setting, the time-lapse movie will be recorded in **FHD 29.97P ALL-I** (NTSC) or **FHD 25.00P ALL-I** (PAL).
- To cancel the time-lapse movie shooting before it is completed, either press the shutter button completely or press the **<START/STOP>** button (**[Disable]** is set). The time-lapse movie shot so far will be recorded on the card.
- You can play back the shot time-lapse movie with this camera the same way that you play back normal movies.
- If the time required for shooting is more than 24 hours but not more than 48, “2 days” will be indicated. If three or more days are required, the number of days will be indicated in 24-hour increments.
- Even if the time-lapse movie’s playback time is less than 1 sec., a movie file will still be created. For **[Playback time]**, “00:00:00” will be displayed.
- If the shooting time is long, using the household power outlet accessories (sold separately, p.530) is recommended.
- In the **<A+>** mode, the scene icon for the scene detected by the camera is displayed on the upper left of the screen (p.303).

-  Do not point the camera toward an intense light source, such as the sun or an intense artificial light source. Doing so may damage the image sensor or the camera's internal components.
- With time-lapse movie set to [Enable], you cannot set [  4: Movie rec. quality ], [  3: Video system ], or other settings.
- If the camera is connected to a computer with the interface cable, or if an HDMI cable is connected to the camera, you cannot select [Enable].
- The maximum ISO speed will be ISO 12800 in the <P>, <Tv>, <Av>, and <B> modes, and in <M> mode with ISO Auto set.
- Bulb exposure cannot be performed. If the shooting mode is <B>, the operation will be the same as with the <P> mode.
- Movie Servo AF will not function.
- If the shutter speed is 1/30 sec. or slower, the exposure of the movie may not be displayed properly (may differ from that of the resulting movie).
- Do not zoom the lens during time-lapse movie shooting. Zooming the lens may cause the image to be out of focus, the exposure to change, or the lens aberration correction not to function properly.
- When shooting a time-lapse movie under a flickering light, noticeable image flickering, horizontal stripes (noise), or irregular exposures may be recorded.
- The image displayed during time-lapse movie shooting and the resulting movie may look different (in terms of flicker, depth of field, etc.).
- If you move the camera from left to right (panning) or shoot a moving subject during time-lapse movie shooting, the image may look extremely distorted.
- During time-lapse movie shooting, auto power off will not take effect. Also, you cannot adjust the shooting function and menu function settings, play back images, etc.
- Sound and time code are not recorded for time-lapse movies.
- Single shooting setting is applied to time-lapse movie shooting regardless of the drive mode setting.
- The shooting function settings for the first shot will be applied to subsequent shots.
- If a shutter speed longer than the shooting interval, such as a long exposure, is set, the camera cannot shoot with the set interval. Also, shooting may not be performed when the shutter speed and the shooting interval are nearly the same.
- If the next scheduled shot is not possible, it will be skipped. This may shorten the recording time of the created time-lapse movie.







- If the time it takes to record to the card exceeds the interval between shots due to the shooting functions set or card performance, some of the shots may not be taken with the set intervals.
- The captured images are not recorded as still photos. Even if you cancel the time-lapse movie shooting after only one shot is taken, it will be recorded as a movie file.
- If the card does not have enough free space to record the set number of shots, **[Playback time]** will be displayed in red. Although the camera can continue shooting, the shooting will stop when the card becomes full.
- If you connect the camera to a computer with the interface cable provided with the camera and use EOS Utility (EOS software), set **[CAM 5: Time-lapse movie]** to **[Disable]**. If it is set to **[Enable]**, the camera cannot communicate with the computer.
- During time-lapse movie shooting, the lens's Image Stabilizer will not operate.
- If the power switch is set to **<OFF>** or the Live View shooting/Movie shooting switch is operated, time-lapse movie shooting will be terminated and the setting is switched to **[Disable]**.
- Even if a flash is used, it will not fire.
- Shooting-ready state of the time-lapse movie is canceled and the setting is switched to **[Disable]** with any of the following operations:
  - Selecting **[CAM 3: Dust Delete Data]**, **[FUNC 3: Sensor cleaning]**, **[FUNC 5: Clear all camera settings]**, or **[FUNC 5: Firmware ver.]**.
  - Selecting **<C1>**, **<C2>**, or **<C3>** shooting modes.
- When time-lapse movie shooting ends, the settings are cleared automatically, and the camera returns to normal movie shooting. Note that if you have set the slow shutter speed for time-lapse movie shooting and the settings are automatically cleared, the shutter speed may be automatically changed to a speed within the settable range for normal movie shooting.
- If you start time-lapse movie shooting while the white **<10>** (p.344) is displayed, the image quality of the time-lapse movie may deteriorate. It is recommended that you start time-lapse movie shooting after the white **<10>** disappears (camera's internal temperature decreases).

 You can shoot time-lapse movies with a fully-charged Battery Pack LP-E6N as shown in the table below (approx. time from start of shooting until the battery becomes exhausted). The possible shooting time will vary depending on the shooting conditions.

**Total Possible Time for Time-lapse Movie Shooting** (Approx.)

Time-lapse Movie Shooting	Room Temperature (23°C / 73°F)	Low Temperatures (0°C / 32°F)
Shooting interval: 1 sec.	3 hr. 50 min.	3 hr. 40 min.
Shooting interval: 10 sec.	5 hr. 20 min.	5 hr. 10 min.

 You can use Remote Controller RC-6 (sold separately, p.279) to start and stop the time-lapse movie shooting. Set [ 5: Remote control] to [Enable].

**When Using Remote Controller RC-6**

Camera Status/Remote Control Setting	<2> (2-sec. delay)	<●> (Immediate shooting)
Test-shooting screen	To shooting-ready	Shoots still photo
Shooting-ready	To test-shooting screen	Starts shooting
During time-lapse movie shooting	Ends shooting	Ends shooting

## MENU Menu Function Settings

### 2

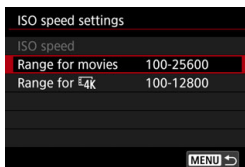

When the Live View shooting/Movie shooting switch is set to <[Live View/Movie]>, the settings for [2: ISO speed settings] will be switched to [ISO speed], [Range for movies], and [Range for 4K].

### ● ISO Speed Settings

#### ● ISO speed

In the <[M]> mode, you can set the ISO speed manually. You can also select ISO Auto. You can also use the <[ISO]> button for these settings.

#### ● Range for movies

For Full HD movie shooting and High Frame Rate (HD) movie shooting, you can set the automatic and manual ISO speed setting ranges (minimum and maximum limits). The default setting is ISO 100 - ISO 25600. You can set the minimum limit within ISO 100 to H1 (equivalent to ISO 51200), and the maximum limit within ISO 200 to H2 (equivalent to ISO 102400).

#### ● Range for 4K

For 4K movie shooting, you can set the automatic and manual ISO speed setting ranges (minimum and maximum limits). The default setting is ISO 100 - ISO 12800. You can set the minimum limit within ISO 100 to H1 (equivalent to ISO 51200), and the maximum limit within ISO 200 to H2 (equivalent to ISO 102400).



- For Full HD and HD shooting, ISO 32000 is the expanded ISO speed. For 4K movie shooting, ISO 16000, 20000, 25600, and 32000 are the expanded ISO speed. When you set them, [H] will be displayed.
- For [2: ISO speed settings] in still photo shooting (viewfinder or Live View shooting), see page 180.

## 4

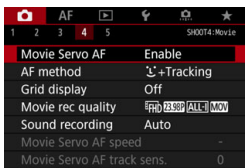

When the Live View shooting/Movie shooting switch is set to <[ ]>, the [4] and [5] tabs will be displayed as the menu options exclusive to movie shooting (the [2] and [3] tabs in <[A+]> mode).

### ● Movie Servo AF

With this function enabled, the camera focuses on the subject continuously during movie shooting. The default setting is **[Enable]**.

#### When **[Enable]** is set:

- The camera focuses on the subject continuously even when you are not pressing the shutter button halfway.
- If you want to keep the focus at a specific point or if you do not want the lens mechanical sound to be recorded, you can temporarily stop Movie Servo AF as follows.
  - Tap on the [SERVO AF] icon on the lower left of the screen.
  - If you assign a button to **[Pause Movie Servo AF]** (p.504) under **[3: Custom controls]**, you can pause Movie Servo AF by pressing that button. When you press the button again, Movie Servo AF will resume.
  - If you assign a button to **[AF stop]** (p.501), you can pause the Movie Servo AF while holding down that button. When you let go of the button, Movie Servo AF will resume.
- While Movie Servo AF is paused, if you return to movie shooting after operations such as pressing the <MENU> or <[ ]> button or changing the AF method, Movie Servo AF will resume.

#### When **[Disable]** is set:

- Press the shutter button halfway or press the <AF-ON> button to focus.





## Cautions When [Movie Servo AF] is Set to [Enable]

- **Shooting Conditions that Make Focusing Difficult**
  - A fast-moving subject approaching or moving away from the camera.
  - A subject moving at a close distance in front of the camera.
  - With a higher f/number
  - Also see “Shooting Conditions that Make Focusing Difficult” on page 324.
- Since this drives the lens continuously, it will consume battery power and shorten the movie shooting time (p.359).
- With certain lenses, the mechanical sound of the lens for focusing may be recorded. If this happens, you can use the Directional Stereo Microphone DM-E1 (sold separately) to reduce the mechanical sound of the lens to be recorded.
- Movie Servo AF will pause during zooming or magnified view.
- During movie shooting, if a subject approaches or moves away or if the camera is moved vertically or horizontally (panning), the recorded movie image may momentarily expand or contract (change in image magnification).
- If you want to set the lens's focus mode switch to <MF> during Movie Servo AF, first set the Live View shooting/Movie shooting switch to <>.

- **AF method**

You can select [**AF+Tracking**], [**FlexiZone - Multi**], or [**FlexiZone - Single**]. See page 316 for the AF method.

- **Grid display**

With [**3x3** , you can display grid lines to help you level the camera vertically or horizontally. Also, with [**3x3+diag** , the grid is displayed together with diagonal lines to help you compose with better balance by aligning the intersections over the subject.

Note that the grid is not displayed during movie shooting.

- **Movie recording quality**

You can set the movie-recording format (MOV or MP4), movie-recording size, 24.00p, and High Frame Rate movie shooting. For details, see page 351.

- **Sound recording**

You can set sound-recording functions. For details, see page 362.

## ● Movie Servo AF Speed <sup>☆</sup>

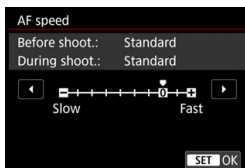
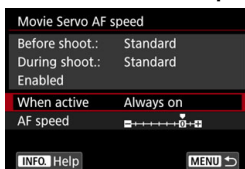

You can set the Movie Servo AF's AF speed and its operation conditions.

This function is settable when [Movie Servo AF] is set to [Enable] and [AF method] is set to [FlexiZone - Single]. Additionally, the function is enabled when using a lens supporting slow focus transition during movie shooting\*.

**When active :** [Always on] sets the AF adjustment speed to take effect at all times for movie shooting (before and during movie shooting). [During shooting] sets the AF adjustment speed to take effect only during movie shooting.

**AF speed :** You can adjust the AF speed (focus transition speed) from standard speed to slow (one of seven levels) or fast (one of two levels) to obtain the desired effect for movie creation.

**\* Lenses supporting slow focus transition during movie shooting**  
USM and STM lenses released in and after 2009 are compatible. For details, refer to Canon Web site.

 Setting [AF method] to [L+Tracking] or [FlexiZone - Multi] gives the same effect as [AF speed] set to [Standard (0)].

## ● Movie Servo AF tracking sensitivity<sup>☆</sup>

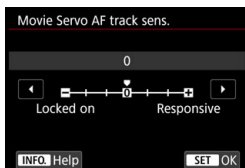

You can change the Movie Servo AF's tracking sensitivity to one of seven levels. This affects the responsiveness of AF tracking sensitivity when the subject strays from the AF points, such as during panning or when an obstacle cuts across the AF points.

This function is settable when [Movie Servo AF] is set to [Enable] and [AF method] is set to [FlexiZone - Single].

### Locked on: -3/-2/-1

This setting makes the camera less inclined to track a different subject if the AF point loses the original subject. The closer the setting is to the minus (-) symbol, the less the camera is inclined to track a different subject. It is effective when you want to prevent the AF points from rapidly tracking something that is not the intended subject during panning or when an obstacle cuts across the AF points.

### Responsive: +1/+2/+3

This makes the camera more responsive when tracking a subject that covers the AF point. The closer the setting is to the plus (+) symbol, the more responsive the camera is. It is effective when you want to keep tracking a moving subject as its distance from the camera changes or to rapidly focus on another subject.

 Setting [AF method] to [L<sup>+</sup> +Tracking] or [FlexiZone - Multi] gives the same effect as setting [0].



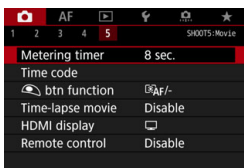



**5**

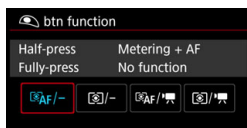

- **Metering timer**<sup>☆</sup>  
You can change how long the exposure setting is displayed (AE lock time).
- **Time code**  
You can set the time code. For details, see page 365.







## ● button function



You can set the functions performed by pressing the shutter button halfway or completely during movie shooting.

Setting	Pressing halfway	Pressing completely
	Metering and AF	No function
	Metering only	No function
	Metering and AF	Starts/stops movie shooting
	Metering only	Starts/stops movie shooting

If [] or [] is set, besides pressing the <START/STOP> button, you can start or stop the movie shooting by pressing the shutter button completely or by using Remote Switch RS-80N3 or Timer Remote Controller TC-80N3 (each sold separately, p.279).

- Even if you set [ 5:  btn function] to [] or [], AF will work in time-lapse movie shooting by pressing the shutter button halfway.
- During movie shooting, the [ 5:  btn function] setting overrides any function assigned to the shutter button with [ 3: Custom Controls].

## ● Time-lapse movie

You can shoot time-lapse movies. For details, see page 371.

## ● HDMI display

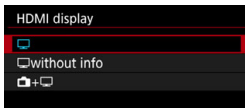

This function enables you to select the display option while recording HDMI video output with an external recording device. The movie will be output in Full HD quality (1920x1080). The default setting is [🖥️].

### ● When [🖥️] is set:

- When outputting a movie via HDMI, the camera's LCD monitor will be off.
- The shooting information, AF points, etc., will be displayed on the HDMI video output. However, if you press the <INFO.> button while watching the external monitor connected to an external recording device, you can see the video output without the information.
- Without having an HDMI connection, even if you press the <INFO.> button while watching the camera's LCD monitor, the output will still display the information.
- To record a video without an information overlay, check that no shooting information or AF point is being displayed on the external monitor, etc. Setting [🖥️ **without info**] is recommended.

### ● When [🖥️ **without info**] is set:

- When outputting a movie via HDMI, the camera's LCD monitor will be off.
- The HDMI output will include only the movie image (shooting information, AF points, etc., will not be displayed).

### ● When [📷+🖥️] is set:

- While displaying the movie on the LCD monitor, you can display the movie as an HDMI output.
- Even if you play back images or display a menu, the images or menu will not be displayed on the HDMI output device.

## ? How to prolong the HDMI output

To continue the HDMI output for longer than 30 min., select [ ] or [ ] **without info**, then set [ **2: Auto Power Off** ] to [ **Disable** ] (p.76).

- HDMI output in 4K quality is not possible. (Even if [ **Movie rec. size** ] is set to 4K, the movie will be output in Full HD quality.)
- HDMI output with no information will not display the card's remaining capacity, battery level, internal temperature warning (p.391), or other warnings on the HDMI output device's screen. Be particularly careful when setting [ ] **without info**. When [ ] + [ ] is set, you can see the warnings displayed on the camera's LCD monitor.
- When you are not shooting a movie, the power will turn off automatically after the set time for [ **2: Auto power off** ] elapses. If you select [ ] + [ ] and set [ **2: Auto power off** ] to [ **Disable** ], the HDMI output will stop if you do not operate the camera for 30 min. (movie shooting will be cancelled).
- With [ ] **without info** set and you press the buttons such as <WB- [ ] > or < [ ]-ISO >, the setting screen may be displayed in the HDMI video output. While recording a movie to an external recording device, operating the buttons is not recommended.
- Depending on the viewing environment, the brightness and color of the movie shot with the camera may look different from that of the HDMI video output recorded by an external recording device.

- By pressing the < **INFO.** > button, you can change the information displayed on the screen.
- A time code can be appended to the HDMI video output (p.367).
- Sound will also be output for the HDMI output (except when [ **Sound rec.: Disable** ] is set).

- **Remote control shooting**

When [**Enable**] is set, you can start or stop movie shooting using Remote Controller RC-6 (sold separately, p.279).

Set the RC-6's release mode switch to <2>, then press the transmit button. If the switch is set to <●> (immediate release), the [ **btn function**] setting will be applied.

## 4

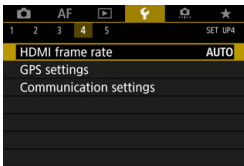

### ● HDMI frame rate

For HDMI output, you can set the frame rate to **[Auto]**, **[59.94i/50.00i]**, **[59.94p/50.00p]**, or **[23.98p]**. Set the frame rate that is compatible with the commercially-available, external recording device you will use to record the movie via HDMI output.

- When **[24.00p]** under **[4: Movie rec quality]** is set to **[Enable]**, you cannot set **[4: HDMI frame rate]**. The movie will be output at 1080/24.00p via HDMI.
- The HDMI output during High Frame Rate movie shooting will not output the movie at 119.9p/100.0p.
- HDMI output with the High Frame Rate setting will have the 59.94p/50.00p movie image according to the **[4: HDMI frame rate]** setting.

- The selectable frame rates vary depending on the **[3: Video system]** setting.
- If the picture does not appear on the HDMI output device, set the **[3: Video system]** correctly to **[For NTSC]** or **[For PAL]** (depending on the video system of the output device).
- If the manually-set frame rate is not compatible with the external recording device, the frame rate will be set automatically.
- If **[4: HDMI frame rate]**'s **[59.94i]** or **[59.94p]** is used with the movie-recording size of **[23.98p]** (23.98 fps), the "2-3 pulldown" process will be performed.



## General Movie Shooting Cautions

### Red <🔴🔥> Internal Temperature Warning Icon

- If the camera's internal temperature increases due to prolonged movie shooting or under a high ambient temperature, a red <🔴🔥> icon will appear.
- The red <🔴🔥> icon indicates that movie shooting will soon be terminated automatically. If this happens, you will not be able to shoot again until the camera's internal temperature decreases. Turn off the power and let the camera rest for a while.
- Shooting a movie at a high temperature for a prolonged period will cause the <🔴🔥> icon to appear earlier. When you are not shooting, always turn off the camera.

### Recording and Image Quality

- If the attached lens has an Image Stabilizer and you set the Image Stabilizer (IS) switch to <ON>, the Image Stabilizer will operate at all times even if you do not press the shutter button halfway. The Image Stabilizer consumes battery power and may shorten the total movie shooting time depending on the shooting conditions. When the Image Stabilizer is not necessary, such as when using a tripod, it is recommended that you set the IS switch to <OFF>.
- With autoexposure shooting or shutter-priority AE, if the brightness changes during movie shooting, the movie image may freeze momentarily. In such a case, shoot movies with aperture-priority AE or manual exposure.
- If there is a very bright light source in the image, the bright area may appear black on the LCD monitor. The movie will be recorded almost exactly as it appears on the LCD monitor.
- In low light, noise or irregular colors may appear in the image. The movie will be recorded almost exactly as it appears on the LCD monitor.
- If you play back a movie with other devices, image or sound quality may deteriorate or playback may not be possible (even if the devices support MOV/MP4 format).

## General Movie Shooting Cautions

### Recording and Image Quality

- If you use a card with a slow writing speed, a five-level indicator may appear on the right of the screen during movie shooting. It indicates how much data has not yet been written to the card (remaining capacity of the internal buffer memory). The slower the card, the faster the indicator will climb upward. If the indicator becomes full, movie shooting will stop automatically. If the card has a fast writing speed, the indicator will either not appear or the level (if displayed) will hardly go upward. First, shoot a few test movies to see if the card can write fast enough.
- If the indicator indicates that the card is full and movie shooting stops automatically, the sound near the end of the movie may not be recorded properly.
- If the card's writing speed is slow (due to fragmentation) and the indicator appears, formatting the card may make the writing speed faster.

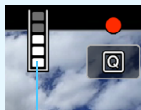

Indicator

## Restrictions on MP4-format Movies

Note that generally, the following restrictions apply to MP4-format movies.

- Sound will not be recorded for approx. the last two frames.
- When you play back movies on Windows, movie images and sound may become slightly out of synchronization.



# 10

## Image Playback

This chapter explains how to play back and erase the captured images (still photos/movies), how to view them on a TV screen, and other playback-related functions.

### **Images shot and saved with another device**

The camera may not be able to properly display images captured with a different camera, edited with a computer, or that have had their file names changed.

# ▶ Image Playback

## Single-Image Display



### 1 Play back the image.

- Press the <▶> button.
- ▶ The last image captured or played back will appear.



### 2 Select an image.

- To play back images starting with the last image captured, turn the <◀> dial counterclockwise. To play back images starting with the first captured image, turn the dial clockwise.
- Each time you press the <INFO.> button, the information display will change.

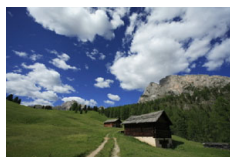

No information



Basic information display



Shooting information display

### 3 Exit the image playback.

- Press the <▶> button to exit the image playback and return to shooting-ready state.



If [**4: Add cropping information**] is set to an option other than [Off] (p.491), the captured images will show the lines indicating the image area when played back.

## Shooting Information Display

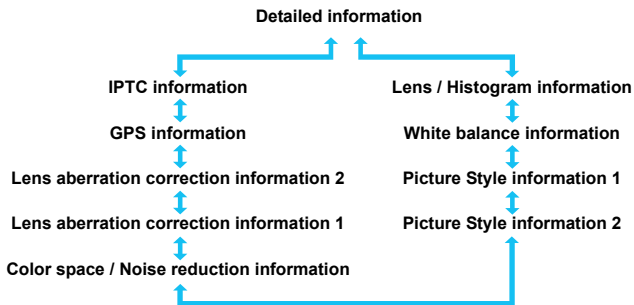

With the shooting information screen displayed (p.394), you can tilt <⬆> up or down to switch the shooting information displayed at the screen bottom as follows. For details, see pages 398-400.

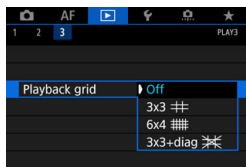

## MENU Grid Display



In single-image display and two-image display (p.408), you can overlay the grid on the image playback.

With [**▶ 3: Playback grid**], you can select [**3x3** , [**6x4** , or [**3x3+diag** ].

This function is convenient for checking the image's vertical or horizontal tilt as well as composition.

# INFO.: Shooting Information Display

## Sample Information for Still Photos

### ● Basic information display

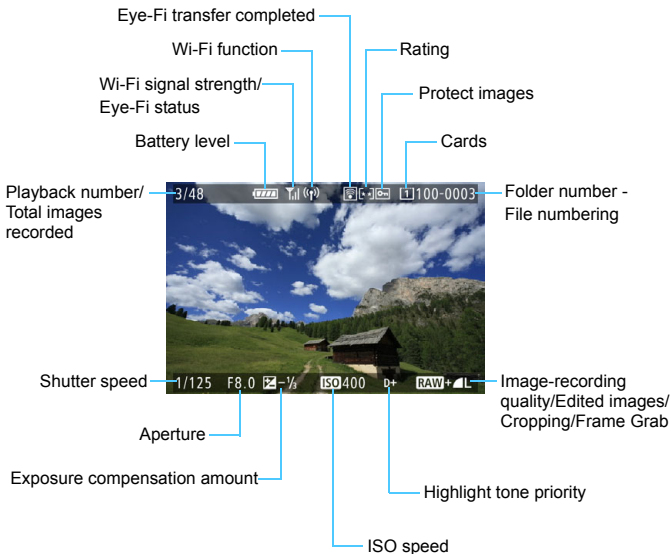

- If the image was taken by another camera, certain shooting information may not be displayed.
- It may not be possible to play back images taken with this camera on other cameras.

## ● Shooting information display

### ● Detailed information

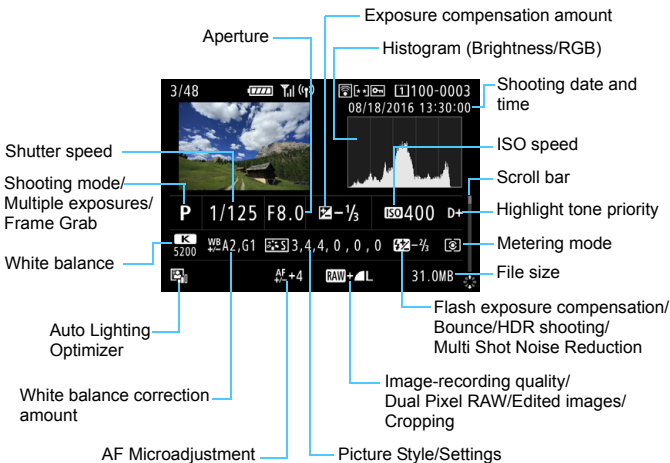

- \* When you shoot in RAW+JPEG image quality, the RAW image file size will be displayed.
- \* Lines indicating the image area will be displayed for images taken with the aspect ratio set (p.310) and with RAW or RAW+JPEG set for image quality.
- \* <DPR> will be displayed for images shot with Dual Pixel RAW shooting.
- \* Lines indicating the image area will be displayed for images with cropping information appended (p.491).
- \* During flash photography without flash exposure compensation, <f> will be displayed.
- \* <!> will be displayed for images shot with bounce shooting.
- \* <HDR> and the dynamic range adjustment amount will be displayed for images shot with HDR shooting.
- \* <M> will be displayed for images shot with multiple-exposure shooting.
- \* <NR> will be displayed for images shot with Multi Shot Noise Reduction.
- \* <C> will be displayed for images created and saved by performing RAW image processing, resizing, cropping, and frame-grabbing.
- \* For images cropped and then saved, <C> will be displayed.

• Lens / Histogram information

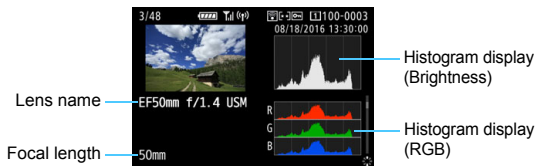

• White balance information

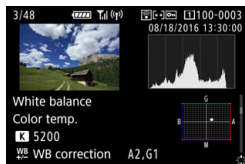

• Picture Style information 1

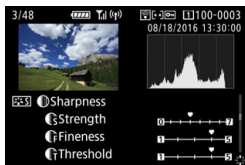

• Picture Style information 2

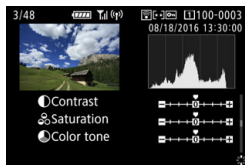

Frame-grab images from 4K movies saved as still photos (p.427) will not display certain shooting information screens.

- **Color space / Noise reduction information**

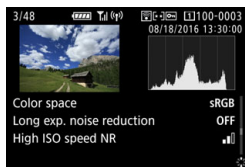

- **Lens aberration correction information 1**

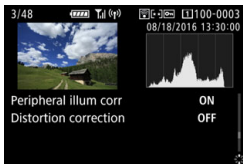

- **Lens aberration correction information 2**

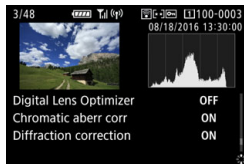

- **GPS information**

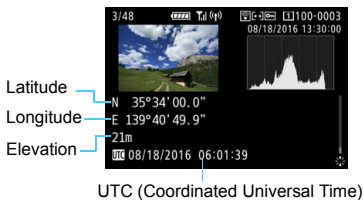

- **IPTC information**

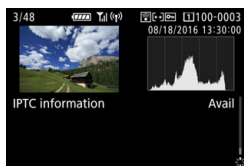

 If the GPS information is not recorded or the IPTC information is not appended to the image, the GPS information screen or IPTC information screen will not be displayed.



## Sample Movie Information Display

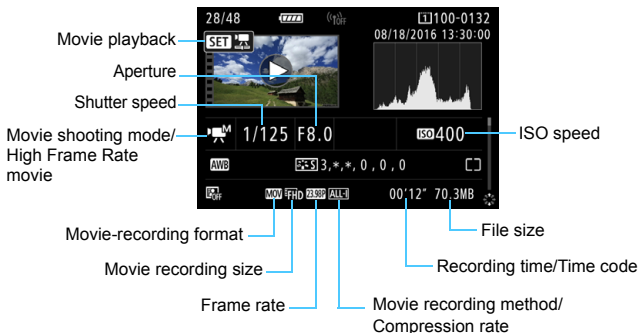

- <M<sup>A</sup>/H<sup>Av</sup>/H<sup>M</sup>>: Shutter speed, aperture, and ISO speed are not displayed.
- <M<sup>v</sup>/H<sup>Tv</sup>>: Aperture and ISO speed are not displayed.
- <M<sup>Av</sup>/H<sup>Av</sup>>: Shutter speed and ISO speed are not displayed.
- <M<sup>M</sup>/H<sup>M</sup>> + ISO Auto: ISO speed is not displayed.

 During movie playback, “\*” will be displayed for **[Fineness]** and **[Threshold]** of **[Picture Style]**'s **[Sharpness]**.

### ● Highlight Alert

When [**3: Highlight alert**] is set to **[Enable]**, overexposed, clipped highlights will blink. To obtain more detailed gradation in the blinking areas where you want the gradation to be faithfully reproduced, set the exposure compensation to a negative amount and shoot again.

- **AF Point Display**

When [**▶3: AF point disp.**] is set to [**Enable**], the AF point that achieved focus will be displayed in red. If automatic AF point selection is set, multiple AF points may be displayed.

- **Histogram**

The brightness histogram shows the exposure level distribution and overall brightness. The RGB histogram is for checking the color saturation and gradation. The display can be switched with [**▶3: Histogram disp.**].

- **[Brightness] Display**

This histogram is a graph showing the distribution of the image's brightness level. The horizontal axis indicates the brightness level (darker on the left and brighter on the right), while the vertical axis indicates how many pixels exist for each brightness level. The more pixels there are toward the left, the darker the image. The more pixels there are toward the right, the brighter the image. If there are too many pixels on the left, the shadow detail will be lost. If there are too many pixels on the right, the highlight detail will be lost. The gradation in-between will be reproduced. By checking the image and its brightness histogram, you can see the exposure level inclination and the overall gradation.

#### Sample Histograms



Dark image



Normal brightness



Bright image

- **[RGB] Display**

This histogram is a graph showing the distribution of each primary color's brightness level in the image (RGB or red, green, and blue). The horizontal axis indicates the color's brightness level (darker on the left and brighter on the right), while the vertical axis indicates how many pixels exist for each color brightness level. The more pixels there are toward the left, the darker and less prominent the color. The more pixels there are toward the right, the brighter and denser the color. If there are too many pixels on the left, the respective color information will be lacking. If there are too many pixels on the right, the color will be too saturated with no gradation. By checking the image's RGB histogram, you can see the color's saturation and gradation condition, as well as white balance inclination.

## ▶ Searching for Images Quickly

### ❑ Display Multiple Images on One Screen (Index Display)

Search for images quickly with the index display showing 4, 9, 36, or 100 images on one screen.



#### 1 Press the **<Q>** button.

- During image playback or when the camera is ready to shoot, press the **<Q>** button.
- ▶ [  **Q** ] will be displayed on the lower right of the screen.



#### 2 Switch to the index display.

- Turn the **<Q>** dial counterclockwise.
- ▶ The 4-image index display will appear. The selected image is highlighted with an orange frame.
- Turning the **<Q>** dial further counterclockwise will switch the display from 9 images, 36 images, and to 100 images. If you turn the dial clockwise, it will rotate through 100, 36, 9, 4, and single-image display.

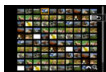
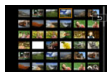

#### 3 Select an image.



- Operate **<Q>** or the **<Q>** dial to move the orange frame and select the image.
- Press the **<Q>** button to turn off the [  **Q** ] icon, then turn the **<Q>** dial to display the image(s) on the next or previous screen.
- Press **<SET>** in the index display to display the selected image in the single-image display.

## Jumping through Images (Jump Display)

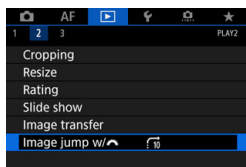
In the single-image display, you can turn the  dial to jump through the images forward or backward according to the jump method set.



### 1 Select [Image jump w/ ].

- Under the [2] tab, select [Image jump w/ ], then press <>.



### 2 Select the jump method.

- Select the jump method, then press <>.

: Display images one by one

: Jump 10 images

: Jump 100 images

: Display by date



: Display by folder

: Display movies only

: Display stills only

: Display protected images only

: Display by image rating (p.415)

Turn the  dial to select. If you browse images with  selected, all the rated images will be displayed.

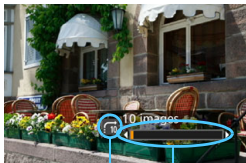

Jump method

Playback position

### 3 Browse by jumping.

- Press the <▶> button to play back images.
- In the single-image display, turn the <◀▶> dial.
- ▶ You can browse by the method that was set.



- To search images by shooting date, select **[Date]**.
- To search images by folder, select **[Folder]**.
- If the card contains both movies and still photos, select **[Movies]** or **[Stills]** to display one or the other.
- If the jump method is set to **[Protect]** or **[Rating]** but no images are protected or have ratings, you cannot use the <◀▶> dial to browse through images.

# Q Magnifying Images



You can magnify a captured image by approx. 1.5x to 10x on the LCD monitor.



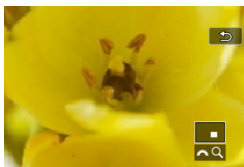
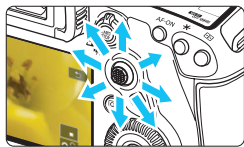

Magnified area position



## 1 Magnify the image.

- The image can be magnified as follows: 1. During image playback (single-image display), 2. During the image review after image capture, and 3. From the shooting-ready state.
- Press the <Q> button.
- ▶ The magnified view will appear. The magnified area and [  Q ] will be displayed on the lower right of the screen.
- The image magnification increases as you turn the <  > dial clockwise. You can magnify the image up to approx. 10x.
- The image magnification decreases as you turn the <  > dial counterclockwise. In the case of 1 and 3 only, turning the dial further will display the index display (p.403).

## 2 Scroll around the image.

- Use <  > to scroll around the magnified image.
- Press the <Q> button or <  > button to exit the magnified view.

- In the case of 1 and 3 only, you can turn the <  > dial to view another image while maintaining the magnified view.
- A movie cannot be magnified.

## MENU Setting the Initial Magnification Ratio and Position

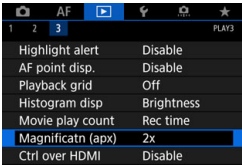

Under the [**3**] tab, when you select [**Magnificatn (apx)**], you can set the initial magnification ratio and position for the magnified view.

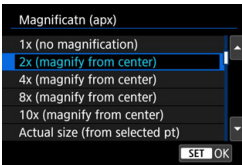

- 1x (no magnification)**  
 The image is not magnified. The magnified view will start with the single-image display.
- 2x, 4x, 8x, 10x (magnify from center)**  
 The magnified view starts at the image center at the selected magnification.
- Actual size (from selected point)**  
 The recorded image's pixels will be displayed at approx. 100%. The magnified view starts at the AF point that achieved focus. If the photo is taken with manual focus, the magnified view starts at the image center.
- Same as last magnification (from center)**  
 The magnification will be the same as the last time you exited the magnified view with the <[▶]> or <[Q]> button. The magnified view starts at the image center.

For images taken with [**Tracking**] or [**FlexiZone - Single**] (p.316), or with [**Distortion correction**] set to [**Enable**] (p.209), the magnified view will start at the image center even if [**Actual size (from selected pt)**] is set.

## ☐ Comparing Images (Two-Image Display) ■

You can compare two images side by side on the LCD monitor. In the two-image display, you can use magnified view or jump display as well as protection, rating and erasure of images.

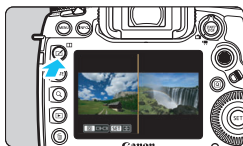

### 1 Set the two-image display.

- During image playback, press the <☐> button.
- ▶ The two-image index display will appear. The selected image is highlighted with an orange frame.

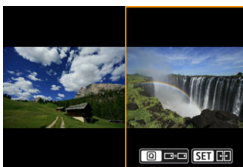

### 2 Select the images to be compared.

- Pressing <SET> switches the orange frame between the two images.
- Turn the <◉> dial to select an image.
- Repeat this procedure to select the other image to be compared.
- If the left and right images are the same, the [☐] icon will appear on the upper left of both images.
- By pressing the <Q> button, you can set the same magnification and magnified area for both images. (The magnification settings will match those of the image not highlighted with an orange frame.)
- By holding the <▶> button, you can display the image highlighted with the orange frame as a single image.
- To return to the previous display, press the <☐> button.

⚠ You cannot start movie playback in the two-image display.

ℹ By pressing the <INFO.> button, you can change the information display.



## Playing Back with the Touch Screen

The LCD monitor is a touch-sensitive panel that you can touch with your fingers for various playback operations. **First, press the <▶> button to play back images.**

### Browsing Images



### Swipe with one finger.

- With single-image display, touch the LCD monitor with **one finger**. You can browse to the next or previous image by swiping your finger to the left or right. Swipe to the left to see the next (newer) image, or swipe to the right to see the previous (older) image.
- With index display, also touch the LCD monitor with **one finger**. You can browse to the next or previous screen by swiping your finger up or down. Swipe up to see the next (newer) images or swipe down to see the previous (older) images. When you select an image, the orange frame will appear. Tap on the image again to display it as a single image.

### Jumping through Images (Jump Display)



### Swipe with two fingers.

Touch the LCD monitor with **two fingers**. When you swipe two fingers to the left or right, you can jump through images with the method set in [Image jump w/ 

## Reducing Image (Index Display)

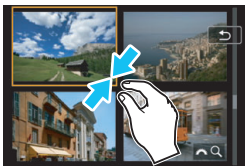

### Pinch two fingers.

Touch the screen with two fingers spread apart, and pinch your fingers together on the screen.

- Each time you pinch your fingers, the image will shrink. If you pinch the single-image display, it will change to the 4-image index display.
- When you select an image, the orange frame will appear. Tap on the image again to display it as a single image.

## Magnifying Image



### Spread two fingers apart.

Touch the screen with two fingers together, then spread your fingers apart on the screen.

- As you spread your fingers, the image will be magnified.
- The image can be magnified up to approx. 10x.
- You can scroll around the image by dragging your fingers.
- If you do this on a 4-image index display, it will change into the single-image display.
- Tapping on the [↶] icon will return to the single-image display.



 Touch operations on the camera's LCD monitor are also possible while playing back images on a TV set connected to your camera (p.432).

## Rotating the Image

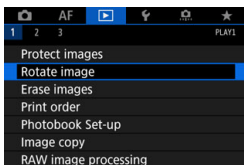
You can rotate the displayed image to the desired orientation.



### 1 Select [Rotate image].

- Under the [ 1] tab, select [Rotate image], then press < >.

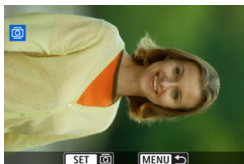

### 2 Select the image to be rotated.



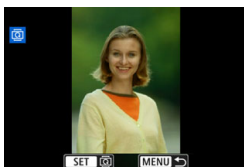



- Turn the < > dial to select the image to be rotated.
- You can also select an image in the index display (p.403).



### 3 Rotate the image.

- Each time you press < >, the image will rotate clockwise as follows: 90° → 270° → 0°.
- To rotate another image, repeat steps 2 and 3.



- If you set [ 1: Auto rotate] to [On  ] (p.444) before taking vertical shots, you need not rotate the image as described above.
- If the rotated image is not displayed in the rotated orientation during image playback, set [ 1: Auto rotate] to [On  ].
- A movie cannot be rotated.

## Protecting Images

You can protect important images from being accidentally erased by the camera's erase function.

### **MENU** Protecting a Single Image

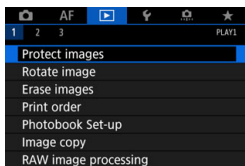

#### 1 Select [Protect images].

- Under the [▶] 1 tab, select [Protect images], then press <SET>.

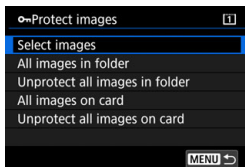

#### 2 Select [Select images].

- An image is displayed.

Image protection icon



#### 3 Select the image to be protected.

- Turn the <◉> dial to select the image to be protected.
- You can also select an image on the index display (p.403).

#### 4 Protect the image.

- Press <SET> to protect the selected image. The <📷> icon will appear at the top of the screen.
- To cancel the image protection, press <SET> again. The <📷> icon will disappear.
- To protect another image, repeat steps 3 and 4.

## MENU Protecting All Images in a Folder or on a Card

You can protect all the images in a folder or on a card at once.

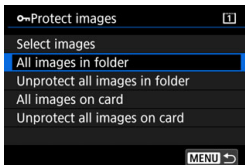

When you select **[All images in folder]** or **[All images on card]** in [**▶** 1: **Protect images**], all the images in the folder or on the card will be protected. To cancel the image protection, select **[Unprotect all images in folder]** or **[Unprotect all images on card]**.

**!** If you format the card (p.73), the protected images will also be erased.



- Movies can also be protected.
- Once an image is protected, it cannot be erased by the camera's erase function. To erase a protected image, you must first cancel the protection.
- If you erase all the images (p.441), only the protected images will remain. This is convenient when you want to erase unnecessary images all at once.
- When **[All images on card]** or **[Unprotect all images on card]** is selected, the images will be protected or unprotected on the card selected for **[Record/play]** or **[Playback]** under [**▶** 1: **Record func+card/folder sel.**].

## Protecting Images with the <RATE> Button

During image playback, you can use the <RATE> button to protect an image.

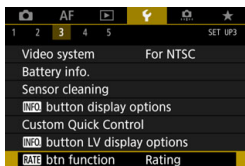

### 1 Select [**RATE** btn function].

- Under the [**3**] tab, select [**RATE** btn function], then press <SET>.

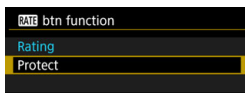

### 2 Select [Protect].



### 3 Select the image to be protected.

- Press the <▶> button to play back images.
- Turn the <DIAL> dial to select the image to be protected.
- You can also select an image on the index display (p.403).

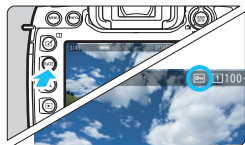

### 4 Protect the image.

- When you press the <RATE> button, the image will be protected and the <ON> icon will appear.
- To cancel the image protection, press the <RATE> button again. The <ON> icon will disappear.
- To protect another image, repeat steps 3 and 4.

# Setting Ratings

You can rate images (still photos and movies) with one of the five rating marks: [★]/[★★]/[★★★]/[★★★★]/[★★★★★]. This function is called rating.

## Rating Images with the <RATE> Button



### 1 Select the image to be rated.

- Press the <▶> button to play back images.
- Turn the <◉> dial to select the image to be rated.
- You can also select an image on the index display (p.403).

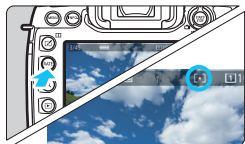

### 2 Rate the image.

- Each time you press the <RATE> button, the rating mark will change: [★]/[★★]/[★★★]/[★★★★]/[★★★★★]/None.
- To rate another image, repeat steps 1 and 2.

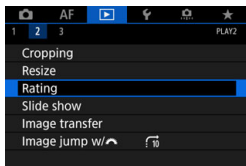

- If [☛3: RATE btn function] is set to [Protect], change it to [Rating].
- If you press the <Q> button when [Rating] is selected in [☛3: RATE btn function], you can set the rating marks that can be selected when you press the <RATE> button.

**MENU** Set Ratings with the Menu**1** Select [Rating].

- Under the [▶] 2 tab, select [Rating], then press <SET>.

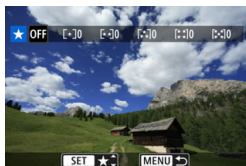
**2** Select the image to be rated.

- Turn the <⊙> dial to select the image to be rated.
- If you press the <Q> button and turn the <⊙> dial counterclockwise, you can select an image from a three-image display. To return to the single-image display, turn the dial clockwise.

**3** Rate the image.

- Press <SET>, and a blue highlight frame will appear as shown in the screenshot.
- Turn the <⊙> dial to select a rating, then press <SET>.
- ▶ When you set a rating mark to the image, the total number of the images displayed beside the rating mark will be counted up.
- To rate another image, repeat steps 2 and 3.

 A total of up to 999 images of a given rating can be displayed. If there are more than 999 images with a given rating, [###] will be displayed.

















## Taking Advantage of Ratings

- With [▶2: **Image jump w/ **], you can display only the images having a specific rating.
- With [▶2: **Slide show**], you can play back only the images having a specific rating.
- Depending on the computer's OS, you can see each file's rating as part of the file information display or in the provided, standard image viewer (JPEG images only).

## Quick Control for Playback

During playback, you can press the <Q> button to set the following: [: **Protect images**], [: Rotate image], [: **Rating**], [: RAW image processing (**RAW** images only)], [: Resize (JPEG image only)], [: Cropping (JPEG images only)], [: **Highlight alert**], [: **AF point display**], [: **Image jump w/ **], and [: **Send images to smartphone\***].

For movies, **only the functions in bold above** can be set.

\* Not selectable if [Built-in wireless settings]'s [Wi-Fi/NFC] is set to [Disable] under [4: Communication settings].

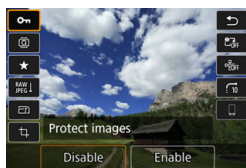



### 1 Press the <Q> button.

- During image playback, press the <Q> button.
- ▶ The Quick Control options will appear.









### 2 Select an item and set it.

- Tilt <> up or down to select a function.
- ▶ The setting of the selected function is displayed at the bottom.
- Turn the <> dial to set it.
- For RAW image processing, Resize, and Cropping, press <> and set the function. For details, see “RAW image processing” (p.446), “Resize” (p.452), or “Cropping” (p.454).
- To cancel, press the <MENU> button.

### 3 Exit the setting.

- Press the <Q> button to exit the Quick Control.

 To rotate an image, set [**1: Auto rotate**] to [**On**  ] (p.444). If [**1: Auto rotate**] is set to [**On** ] or [**Off**], the [**Rotate image**] setting will be recorded to the image, but the camera will not rotate the image for display.

- 
- Pressing the <> button during the index display will switch to the single-image display, and the Quick Control screen will appear. Pressing the <> button again will return to the index display.
  - For images taken with another camera, the options you can select may be restricted.

## Enjoying Movies

The three main ways to play back and enjoy movies are as follows:

### Playback on a TV Set (p.432)



By connecting the camera to a TV set with HDMI Cable HTC-100 (sold separately), you can play back the camera's still photos and movies on the TV set.

- When the camera is connected to a TV set with an HDMI cable, even 4K movies will be played back in Full HD quality (they cannot be played back in 4K quality).
- Since hard disk recorders do not have an HDMI IN port, the camera cannot be connected to a hard disk recorder with an HDMI cable.
- Even if the camera is connected to a hard disk recorder with a USB cable, movies and still photos cannot be played back or saved.

### Playback on the Camera's LCD Monitor (p.422)

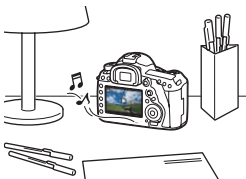

You can play back movies on the camera's LCD monitor.

You can also edit out the movie's first and last scenes, select a desired frame from a 4K movie and save it as a still photo, and play back the still photos and movies on the card in an automatic slide show.

- A movie edited with a computer cannot be rewritten to the card and played back with the camera.

## Playback and Editing with a Computer



The movie files recorded on the card can be transferred to a computer and played back or edited with pre-installed or general-purpose software compatible with the movie's recording format.



- To play back or edit a movie with commercially-available software, use software compatible with MOV-format and MP4-format movies. For details on commercially-available software, contact the software manufacturer.
- MOV-format movies can also be played back with EOS MOVIE Utility (EOS software, p.599).

## ▶▶ Playing Back Movies



### 1 Play back the image.

- Press the <▶> button to play back images.

### 2 Select a movie.

- Turn the <⌚> dial to select the movie to be played back.
- In the single-image display, the <SET ▶> icon displayed on the upper left indicates a movie.
- In the index display, perforations at the left edge of a thumbnail indicate a movie. **As movies cannot be played back from the index display, press <SET> to switch to the single-image display.**



### 3 In the single-image display, press <SET>.

- ▶ The movie playback panel will appear at the bottom of the screen.



### 4 Play back the movie.

- Turn the <⌚> dial to select [▶] (Play), then press <SET>.
- ▶ The movie will start playing back.
- You can pause the movie playback by pressing <SET>. Press it again to resume the playback.















Speaker

- You can adjust the sound volume during movie playback by turning the <⌚> dial.
- For more details on the playback procedure, see the next page.

- Before listening to a movie through headphones, turn down the volume to avoid hurting your ears.
- The camera may not be able to play back movies shot with another camera.

## Movie Playback Panel

Operation	Playback Description
 <b>Play</b>	Pressing <SET> toggles between play and stop.
 <b>Slow motion</b>	Adjusts the slow motion speed by turning the <DIAL> dial. The slow motion speed is indicated on the upper right of the screen.
 <b>First frame</b>	Displays the movie's first frame.
 <b>Previous frame</b>	Displays the previous frame each time you press <SET>. Holding down <SET> will rewind the movie.
 <b>Next frame</b>	Plays the movie frame-by-frame each time you press <SET>. Holding down <SET> will fast forward the movie.
 <b>Last frame</b>	Displays the movie's last frame.
 <b>Edit</b>	Displays the editing screen (p.425).
 <b>Frame Grab</b>	Selectable when a 4K movie is played. You can grab the frame displayed on the screen and save it as a still photo (JPEG image, p.427).
	Playback position
mm' ss"	Playback time (minutes:seconds with <b>[Movie play count: Rec time]</b> set)
hh:mm:ss.ff (DF) hh:mm:ss:ff (NDF)	Time code (hours:minutes:seconds:frames with <b>[Movie play count: Time code]</b> set)
 <b>Volume</b>	Adjusts the volume of the built-in speaker (p.422) or headphones by turning the <DIAL> dial.
 <b>MENU</b> 	Returns to the single-image display by pressing the <MENU> button.

## Playback with the Touch Screen

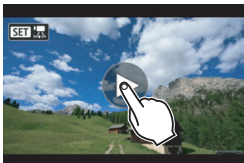

Tap [▶] at the center of the screen.

- ▶ The movie will start playing back.
- To display the movie playback panel, tap <SET ▶▶▶> on the upper left of the screen.
- To pause the movie while it is playing back, tap on the screen. The movie playback panel will also appear.

## Playing High Frame Rate Movies

HD movies shot at a high frame rate (119.9 fps or 100.0 fps) will be played back at 1/4-speed slow motion (29.97 fps or 25.00 fps). No sound will be played back because no sound is recorded when shooting High Frame Rate movies. Note that each second of playback time and the time code count up equals to 1/4 sec. in real time.

- If you connect the camera to a TV set to play a movie (p.432), adjust the sound volume with the TV set. (Turning the <🔊> dial will not change the sound volume.)
- If you detach or attach the lens, the card's writing speed is slow, or the movie file contains corrupted frames during movie playback, the movie playback will stop.

- With a fully-charged Battery Pack LP-E6N, the continuous playback time at room temperature (23°C/73°F) will be approx. 2 hr. 30 min. (with the following settings: [FHD] 29.97P / 25.00P / 24.00P / 23.98P [IPB]).
- By connecting commercially-available headphones equipped with a 3.5 mm diameter stereo mini plug to the camera's headphone terminal (p.29), you can listen to the movie sound (p.363).



## ✂ Editing a Movie's First and Last Scenes

You can edit out the first and last scenes of a movie in approx. 1-sec. increments.



### 1 On the movie playback screen, select [✂].

- ▶ The movie editing panel will be displayed at the bottom of the screen.



### 2 Specify the part to be edited out.

- Select either [✂] (Cut beginning) or [✂] (Cut end), then press <SET>.
- Tilt <⦿> to the left or right to see the previous or next frames. Holding down the key will fast forward or fast rewind the frames. Turn the <⦿> dial for frame-by-frame playback.
- After deciding which part to edit out, press <SET>. The portion highlighted in white on the top of the screen is what will remain.



### 3 Check the edited movie.

- Select [▶] and press <SET> to play back the edited movie.
- To change the editing part, go back to step 2.
- To cancel the editing, press the <MENU> button, then select [OK] on the confirmation dialog.





## 4 Save the edited movie.

- Select [**X**], then press <Ⓔ>.
- ▶ The save screen will appear.
- To save it as a new movie, select [**New file**]. To save it and overwrite the original movie file, select [**Overwrite**], then press <Ⓔ>.
- On the confirmation dialog, select [**OK**] to save the edited movie and return to the movie playback screen.

- Since the editing is performed in approx. 1-sec. increments (position indicated by [**X**] on the top of the screen), the actual position where the movie is edited may differ from the position you specified.
- If the card does not have enough free space, [**New file**] will not be available.
- When the battery level is low, movie editing is not possible. Use a fully-charged battery.
- Movies shot with another camera cannot be edited with this camera.
- You cannot edit a movie when the camera is connected to a computer.



## Grabbing a Frame from 4K Movies

From a 4K movie, you can select any desired frame to save it as an approx. 8.8 megapixel (4096x2160) still photo (JPEG image). This function is called “Frame Grab (4K frame capture)”.

### 1 Play back the image.

- Press the <▶> button to play back images.

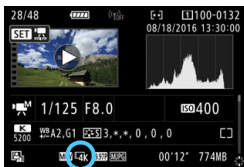

### 2 Select a 4K movie.

- Turn the <◉> dial and select a 4K quality movie.
- On the shooting information screen (p.401), the 4K movie is indicated with the [4K] icon.
- With the index display, press <SET> to switch to the single-image display.

### 3 In the single-image display, press <SET>.

- ▶ The movie playback panel will appear at the bottom of the screen.



### 4 Select a frame to grab.

- Use the movie playback panel to select the frame to grab as a still photo.
- For details on using the movie playback panel, see page 423.



### 5 Select [◉].

- Turn the <◉> dial to select [◉], then press <SET>.



## 6 Save the frame.

- Select [**OK**] to save the frame displayed on the screen as a still photo (JPEG image).
- Check the destination folder and image file number.

## 7 Select the image to be displayed.

- Select [**View original movie**] or [**View extracted still image**].
- ▶ The selected image will be displayed.

- Frame grabbing is not possible with Full HD movies or 4K movies shot with a different camera.
- Frame grabbing is not possible if the camera is connected to a computer.

## MENU Slide Show (Auto Playback)

You can play back the images on the card as an automatic slide show.

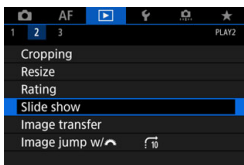

### 1 Select [Slide show].

- Under the [▶2] tab, select [Slide show], then press <SET>.

Number of images to be played back

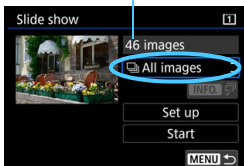

### 2 Select the images to be played back.

- Select the desired option on the screen, then press <SET>.

#### All images/Movies/Stills/Protect

- Turn the <◉> dial to select one of the following: [📁 All images] [🎬 Movies] [📷 Stills] [🔒 Protect]. Then press <SET>.

#### Date/Folder/Rating

- Turn the <◉> dial to select one of the following: [📅 Date] [📁 Folder] [★ Rating].
- When <INFO ✓> is highlighted, press the <INFO.> button.
- Select the desired setting, then press <SET>.

#### Date

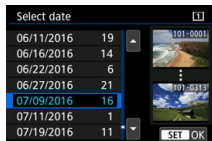

#### Folder



#### Rating

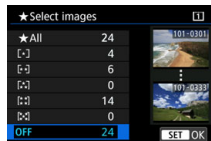

Item	Playback Description
<b>All images</b>	All the still photos and movies on the card will be played back.
<b>Date</b>	Still photos and movies taken on the selected shooting date will be played back.
<b>Folder</b>	Still photos and movies in the selected folder will be played back.
<b>Movies</b>	Only the movies on the card will be played back.
<b>Stills</b>	Only the still photos on the card will be played back.
<b>Protect</b>	Only the protected still photos and movies on the card will be played back.
<b>Rating</b>	Only the still photos and movies with the selected rating will be played back.

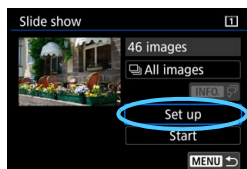

### 3 Set the playback as desired.

- Select [**Set up**], then press < (SET) >.
- Set the [**Display time**] and [**Repeat**] settings for still photos.
- After completing the settings, press the < **MENU** > button.

#### Display time

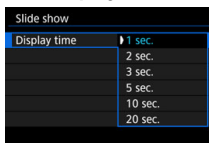

#### Repeat

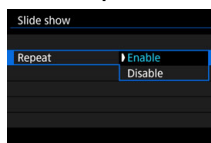

The images on the card selected for [**Record/play**] or [**Playback**] under [**F1: Record func+card/folder sel.**] will be played back.

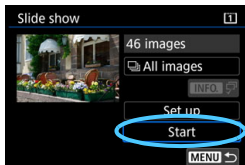

#### 4 Start the slide show.

- Select [**Start**], then press <SET>.
- ▶ After [**Loading image...**] is displayed, the slide show will start.

#### 5 Exit the slide show.

- To exit the slide show and return to the setting screen, press the <MENU> button.



- To pause the slide show, press <SET>. During pause, [III] will be displayed on the upper left of the image. Press <SET> again to resume the slide show.
- During the automatic playback of still images, you can press the <INFO.> button to switch the display format (p.394).
- During movie playback, you can adjust the sound volume by turning the <VOLUME> dial.
- During auto playback or pause, you can turn the <DISP.> dial to view another image.
- During auto playback, auto power off will not take effect.
- The display time may differ depending on the image.
- To view the slide show on a TV set, see page 432.

## Viewing Images on a TV Set

By connecting the camera to a TV set with an HDMI cable (sold separately), you can play back the camera's still photos and movies on the TV set. For the HDMI cable, HDMI Cable HTC-100 (sold separately) is recommended. If the picture does not appear on the TV screen, check if the [F3: Video system] is correctly set to [For NTSC] or [For PAL] (depending on the video system of your TV set).

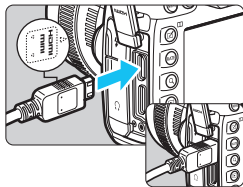

### 1 Connect the HDMI cable to the camera.

- With the plug's <▲ HDMI MINI> logo facing the front of the camera, insert it into the <HDMI OUT> terminal.

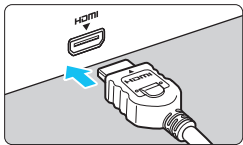

### 2 Connect the HDMI cable to the TV set.

- Connect the HDMI cable to the TV set's HDMI IN port.

### 3 Turn on the TV set and switch the TV set's video input to select the connected port.

### 4 Set the camera's power switch to <ON>.

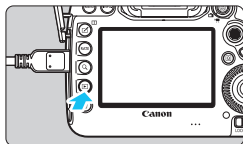

### 5 Press the <▶> button.

- ▶ The image will appear on the TV screen. (Nothing will be displayed on the camera's LCD monitor.)
- The images will automatically be displayed at the optimum resolution matching the connected TV set.
- By pressing the <INFO.> button, you can change the display format.
- To play back movies, see page 422.



- When the camera is connected to a TV set with an HDMI cable, even 4K movies will be played back in Full HD quality (they cannot be played back in 4K quality).
- Adjust movie sound volume with the TV set. The sound volume cannot be adjusted with the camera.
- Before connecting or disconnecting the cable between the camera and TV set, turn off the camera and TV set.
- Depending on the TV set, part of the image displayed may be cut off.
- Do not connect any other device's output to the camera's <HDMI OUT > terminal. Doing so may cause a malfunction.
- Certain TV sets may not display the images due to incompatibility.

## Using HDMI CEC TV Sets

If the TV set connected to the camera with an HDMI cable is compatible with HDMI CEC\*, you can use the TV set's remote control for playback operations.

\* An HDMI-standard function enabling HDMI devices to control each other so that you can control them with one remote control unit.

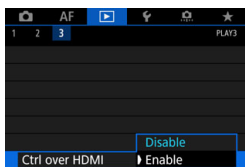

- 1 Select [Ctrl over HDMI].**
  - Under the [▶] 3 tab, select [Ctrl over HDMI], then press <SET>.
- 2 Select [Enable].**
- 3 Connect the camera to a TV set.**
  - Use an HDMI cable to connect the camera to the TV set.
  - ▶ The TV set's input will switch automatically to the HDMI port connected to the camera. If it does not switch automatically, use the TV set's remote control to select the HDMI IN port the cable is connected to.

## 4 Press the camera's <▶> button.

- ▶ An image will appear on the TV screen and you can use the TV set's remote control for playback.

## 5 Select an image.

- Point the remote control toward the TV set and press the ←/→ button to select an image.

## Still photo playback menu **6 Press the remote control's Enter button.**



- ▶ The menu appears and you can perform the playback operations shown on the left.

### Movie playback menu



- Press the remote control's ←/→ button to select the desired option, then press the Enter button. For a slide show, press the ↑/↓ button to select an option, then press the Enter button.
- If you select [**Return**] and press the Enter button, the menu will disappear and you can use the ←/→ button to select an image.

- ↶ : Return
- ☐☐☐ : 9-image index
- 🎬 : Play movie
- 🖱️ : Slide show
- INFO. : Display shooting info
- 🔄 : Rotate

ⓘ During the two-image display (p.408), playback with the TV set's remote control is not possible. To use the TV's remote control for playback, first press the <▶> button to return to the single-image display.

- ⓘ ● Certain TV sets require you to first enable the HDMI CEC connection. For details, refer to the TV set's Instruction Manual.
- Certain TV sets, even those compatible with HDMI CEC, may not be operated properly. In such a case, set [▶3: **Ctrl over HDMI**] to [**Disable**], and use the camera to control the playback operation.

## Copying Images

You can copy the images recorded on one card (save duplicates) to the other card.

### Movie Files Exceeding 4 GB

- If you are copying images between cards and the copy target card is formatted in FAT32 (p.74), movie files exceeding 4 GB recorded on the exFAT-formatted copy source card cannot be copied.
- Movie files exceeding 4 GB can be copied between cards when both Card1 (1) and Card2 (2) are formatted in exFAT.

## **MENU** Copying a Single Image

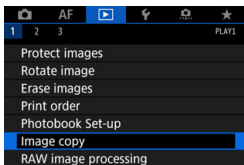

### 1 Select [Image copy].

- Under the [1] tab, select [Image copy], then press <SET>.

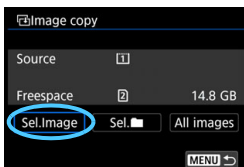

### 2 Select [Sel. Image].

- Check the copy source card's number, the target card's number and its remaining capacity.
- Select [Sel. Image], then press <SET>.

 The copy source is the card selected for [Record/play] or [Playback] under [1: Record func+card/folder sel.].



### 3 Select the folder.

- Select the folder containing the image you want to copy, then press **<SET>**.
- Check the images displayed on the right to select the desired folder.
- ▶ The images in the selected folder will be displayed.

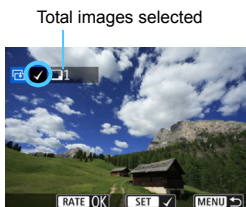

### 4 Select the images to be copied.

- Turn the **<DISP>** dial to select an image to be copied, then press **<SET>**.
- ▶ The **[✓]** icon will appear on the upper left of the screen.
- If you press the **<Q>** button and turn the **<DISP>** dial counterclockwise, you can select an image from a three-image display. To return to the single-image display, turn the dial clockwise.
- To select another image to be copied, repeat step 4.

### 5 Press the **<RATE>** button.

- After selecting all the images to be copied, press the **<RATE>** button.

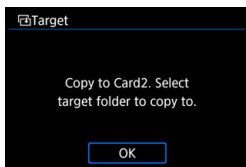

### 6 Select **[OK]**.

- Check the card where the images will be copied to, then select **[OK]**.

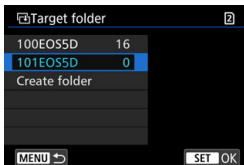

## 7 Select the target folder.

- Select the target folder to which you want to copy the images, then press **<SET>**.
- To create a new folder, select **[Create folder]**.

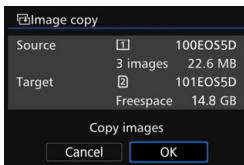

## 8 Select [OK].

- Check the information of the source card and target card, then select **[OK]**.
- ▶ The copying will start and the progress will be displayed.
- When the copying is completed, the result will be displayed. Select **[OK]** to return to the screen in step 2.

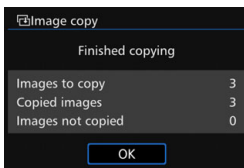

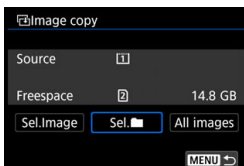

## **MENU** Copying All Images in a Folder or on a Card

You can copy all the images in a folder or on a card at once.



Under **[▶ 1: Image copy]**, when you select **[Sel. [Folder Icon]]** or **[All images]**, you can copy all the images in the folder or on a card.

- 
- If an image is being copied to a target folder/card which has an image with the same file number, the following will be displayed: **[Skip image and continue]** **[Replace existing image]** **[Cancel copy]**. Select the copying method, then press <  >.
    - **[Skip image and continue]**: Any images having the same file number will be skipped and not copied.
    - **[Replace existing image]**: Any images having the same file number (including protected images) will be overwritten.
- If an image with a print order (p.471) is overwritten, you will have to set the print order again.
- If **[Sel. ■■]** or **[All images]** is selected and the folder or card has a movie file exceeding 4 GB that cannot be copied to the target, a message will appear. Only the still photos and the movie files not exceeding 4 GB will be copied.
  - The image's print order information, image transfer information, or photo book order information will not be retained when the image is copied.
  - Shooting is not possible during the copying process. Select **[Cancel]** before shooting.

- 
- The file name of the copied image will be the same as the original image's file name.
  - If **[Sel. Image]** is set, you cannot copy images in multiple folders at once. Select images in each folder to copy them folder by folder.

## Erasing Images

You can either select and erase unnecessary images one by one or erase them in one batch. Protected images (p.412) will not be erased.

**!** Once an image is erased, it cannot be recovered. Make sure you no longer need the image before erasing it. To prevent important images from being erased accidentally, protect them. Erasing a RAW+JPEG image will erase both the RAW and JPEG images.

### Erasing a Single Image

#### 1 Select the image to be erased.

- Press the <▶> button to play back images.
- Turn the <◉> dial to select the image to be erased.



#### 2 Press the <🗑> button.

- ▶ The Erase menu will appear.

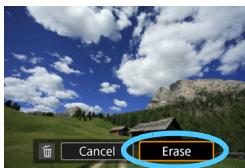

#### 3 Erase the image.

- Select [Erase], then press <SET>. The image displayed will be erased.

 Setting [**4: Default Erase option**] to **[[Erase] selected]** makes it faster to erase images (p.492).

## MENU Checkmarking [✓] Images to Be Erased in a Batch

By adding checkmarks <✓> to the images to be erased, you can erase multiple images at once.

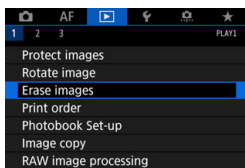

### 1 Select [Erase images].

- Under the [▶] 1 tab, select [Erase images], then press <SET>.

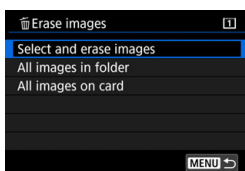

### 2 Select [Select and erase images].

- ▶ An image is displayed.



### 3 Select the images to be erased.

- Turn the <⦿> dial to select the image to be erased, then press <SET>.
- ▶ A checkmark [✓] will be displayed on the upper left of the screen.
- If you press the <Q> button and turn the <⚙> dial counterclockwise, you can select an image from a three-image display. To return to the single-image display, turn the <⚙> dial clockwise.
- To select another image to be erased, repeat step 3.

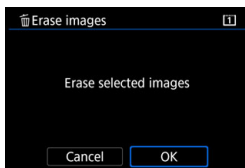

### 4 Erase the image.

- Press the <🗑> button, then press [OK].
- ▶ The selected images will be erased at once.



## MENU Erasing All Images in a Folder or on a Card

You can erase all the images in a folder or on a card at once.

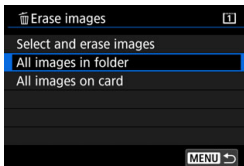

When [**▶ 1: Erase images**] is set to [**All images in folder**] or [**All images on card**], all the images in the folder or on the card will be erased.



- To erase all images including protected images, format the card (p.73).
- When [**All images on card**] is selected, the images in the card selected under [**1: Record func+card/folder sel.**] with [**Record/play**] or [**Playback**] will be erased.

# Changing Image Playback Settings

## MENU Adjusting the LCD Monitor Brightness

The LCD monitor's brightness is adjusted automatically for optimum viewing depending on the ambient light level. You can also set the brightness level of automatic adjustment (brighter or darker), or adjust the brightness manually.

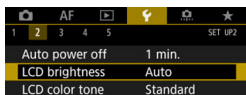

### 1 Select [LCD brightness].

- Under the [**F2**] tab, select [**LCD brightness**], then press <[**SET**]>.

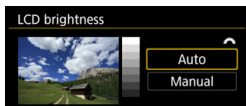

### 2 Select [Auto] or [Manual].

- Turn the <[**W**]> dial to make the selection.

### 3 Adjust the brightness.

- While referring to the gray chart, turn the <[**Q**]> dial, then press <[**SET**]>.
- You can adjust the brightness level to one of three levels with [**Auto**], and to one of seven levels with [**Manual**].

#### Automatic adjustment

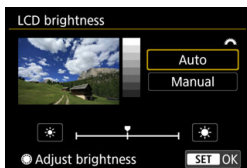

#### Manual adjustment

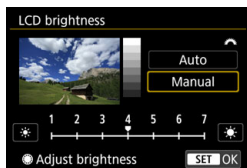

With [**Auto**] set, be careful not to obstruct the round, external light sensor (p.29) on the lower left of the Quick Control Dial with your finger, etc.

- To check the image's exposure, referring to the histogram is recommended (p.402).
- During playback, pressing the <[**Q**]> button will display the screen in step 2.
- The last image played back will appear for the screen in step 2.

**MENU** Setting the LCD Monitor Color Tone

You can change the LCD monitor's color tone from standard tone to warm or cool tone.

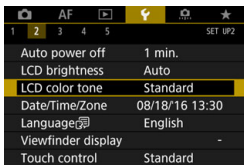
**1** Select [LCD color tone].

- Under the [**2**] tab, select [**LCD color tone**], then press <SET>.

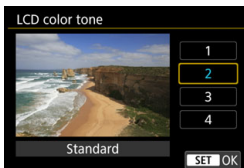
**2** Select the desired color tone.

- While looking at the image on the LCD monitor, select an option (1, 2, 3, or 4), then press <SET>.
- You can select [**1: Warm tone**], [**2: Standard**], [**3: Cool tone 1**], or [**4: Cool tone 2**].

 The last image played back is displayed on the screen in step 2.

## MENU Auto Rotation of Vertical Images

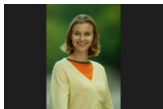

Images shot in vertical orientation are rotated automatically to the proper orientation for viewing, so they will not be displayed in horizontal orientation when played back on the camera's LCD monitor or viewed on a computer screen. You can change the setting of this feature.

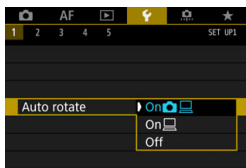

### 1 Select [Auto rotate].

- Under the [**1**] tab, select [**Auto rotate**], then press <SET>.

### 2 Set the display orientation.

- Select the desired setting, then press <SET>.

- On**  

The vertical image is automatically rotated during playback on both the camera's LCD monitor and on the computer.

- On** 

The vertical image is automatically rotated only on the computer.

- Off**

The vertical image is not automatically rotated.

 Auto rotation will not work with vertical images captured while auto rotation was [**Off**]. They will not rotate even if you later switch it to [**On**] for playback.

-  The image displayed immediately after shooting will not be automatically rotated.
- If a picture is taken while the camera is pointing up or down, automatic rotation to the proper orientation for viewing may not be performed correctly.
- If the vertical image is not automatically rotated on the computer screen, it means the software you are using does not support image rotation for display. Using the EOS software is recommended.

# 11

## Post-Processing Images

This chapter explains RAW image processing, JPEG image resizing, and JPEG image cropping.

- A ☆ icon at the upper right of a page title indicates a function that can be used only in the following modes: <P> <Tv> <Av> <M> <B>.



- The camera may not be able to process images taken with another camera.
- Post-processing images as described in this chapter cannot be performed when the camera is connected to a computer via an interface cable.

## RAW/JPEG ↓ Processing RAW Images with the Camera ☆

You can process **RAW** images with the camera and save them as JPEG images. As the RAW image itself does not change, you can apply different processing conditions to create any number of JPEG images from it.

**Note that M RAW and S RAW images cannot be processed with the camera.** Use Digital Photo Professional (EOS software, p.598) to process those images.

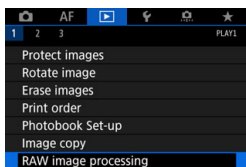

### 1 Select [RAW image processing].

- Under the [▶ 1] tab, select [**RAW image processing**], then press <SET>.
- ▶ **RAW** images will be displayed.



### 2 Select the image to be processed.

- Turn the <⦿> dial to select the image you want to process.
- If you press the <Q> button and turn the <⚙> dial counterclockwise, you can select an image from the index display.



### 3 Set the desired processing conditions.

- Press <SET> to make the RAW-processing options appear in a while (p.449).
- Use <⦿> to select an option, then turn the <⦿> or <⚙> dial to switch the setting.
  - ▶ The displayed image will reflect such settings as “Brightness adjustment”, “White balance”, etc.
- To return to the image settings at the time of shooting, press the <INFO.> button.

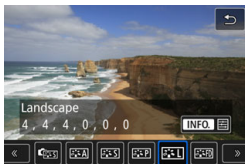

## Displaying the setting screen

- Press <SET> to display the selected function's setting screen. Turn the <◂> or <◃> dial to change the setting. Press <SET> to finalize the setting and return to the previous screen.



## 4 Save the image.

- Select [L] (Save), then press <SET>.
- When you select [OK], the JPEG image created by processing will be saved to the card.
- Check the destination folder and image file number, then select [OK].
- To process another image, repeat steps 2 to 4.

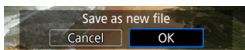

## Magnified View

You can magnify the image by pressing the <Q> button in step 3. The magnification will differ depending on the **[Image quality]** setting under **[▶ 1: RAW image processing]**. With <⊗>, you can scroll around the magnified image.

To cancel the magnified view, press the <Q> button again.

## Images with Aspect Ratio Setting

With **[📷 5: Aspect ratio]** (p.310) set to an option other than **[3:2]**, frame lines indicating the image area will be displayed on the shot images. JPEG images generated from **RAW** images will be saved with the set aspect ratio.





## Dual Pixel RAW images

The RAW images (p.175) shot with **[📷 1: Dual Pixel RAW]** set to **[Enable]** can be processed with the camera. However, it cannot process the RAW image using the Dual Pixel data.

 When you process multiple-exposure **RAW** images, certain settings cannot be changed.



## RAW Image Processing Options

-  **Brightness adjustment**  
You can adjust the image brightness up to  $\pm 1$  stop in 1/3-stop increments. The displayed image will reflect the setting's effect.
-  **White balance** (p.192)  
You can select the white balance. If you select [**AWB**] and press the <**INFO.**> button, you can select [**Auto: Ambience priority**] or [**Auto: White priority**]. If you select [**K**] and press the <**INFO.**> button, you can set the color temperature. The displayed image will reflect the setting's effect.
-  **Picture Style** (p.183)  
You can select the Picture Style. By pressing the <**INFO.**> button, you can adjust the sharpness, contrast, and other parameters. The displayed image will reflect the setting's effect.
-  **Auto Lighting Optimizer** (p.201)  
You can set the Auto Lighting Optimizer. The displayed image will reflect the setting's effect.
-  **High ISO speed noise reduction** (p.202)  
You can set the noise reduction processing for high ISO speeds. The displayed image will reflect the setting's effect. If the effect is difficult to discern, magnify the image (p.448).
- **L Image quality** (p.169)  
You can set the image quality when creating a JPEG image.

- sRGB **Color space** (p.217)

You can select either sRGB or Adobe RGB. Since the camera's LCD monitor is not compatible with Adobe RGB, the difference in the image will hardly be perceptible when either color space is set.

-  **Lens aberration correction**

- OFF **Peripheral illumination correction** (p.207)

A phenomenon that makes the image corners look darker due to the lens characteristics can be corrected. If **[Enable]** is set, the corrected image will be displayed. If the effect is difficult to discern, magnify the image (p.448) and check the four corners.

The peripheral illumination correction applied with the camera will be less pronounced than that applied with the Digital Photo Professional (p.598) at maximum correction amount. If the effects of correction are not apparent, use Digital Photo Professional to apply the peripheral illumination correction.



- OFF **Distortion correction** (p.209)

Image distortion due to lens characteristics can be corrected. If **[Enable]** is set, the corrected image will be displayed. The image periphery will be trimmed in the corrected image.

Since the image resolution may look slightly lower, adjust the sharpness with the Picture Style's **[Sharpness]** parameter setting as necessary.

- OFF **Digital Lens Optimizer** (p.210)

By using optical design values, the lens aberrations, diffraction phenomenon, and degraded resolution due to the low-pass filter can be corrected. Check the effects of the **[Enable]** setting with the magnified view (p.448). The unmagnified view (normal view) will not show the effects of the Digital Lens Optimizer. When **[Enable]** is selected, the chromatic aberration correction and diffraction correction options will not be displayed. However, both options will be applied to the processed image.

-  **Chromatic aberration correction** (p.211)  
 Chromatic aberrations (color fringing along the subject's outline) due to the lens characteristics can be corrected. If **[Enable]** is set, the corrected image will be displayed. If the effect is difficult to discern, magnify the image (p.448).
-  **Diffraction correction** (p.212)  
 The diffraction by the lens aperture degrading the image sharpness can be corrected. If **[Enable]** is set, the corrected image will be displayed. If the effect is difficult to discern, magnify the image (p.448).



- Processing RAW images in the camera will not produce exactly the same results as processing RAW images with Digital Photo Professional (EOS software).
- If you perform **[Brightness adjustment]**, noise, banding, etc. may be intensified with the effects of adjustment.
- When **[Digital Lens Optimizer]** is set, noise may be intensified with the effects of correction. Also, depending on the shooting conditions, stronger application of outline emphasis may result. If necessary, adjust the Picture Style's Sharpness.
- When processing images with **[Distortion correction]** set to **[Enable]**, AF point display information (p.402) or Dust Delete Data (p.460) will not be appended to the image.



- The lens correction data for lens aberration corrections is registered (stored) in the camera.
- The effect of the lens aberration correction varies depending on the lens used and shooting conditions. Also, the effect may be difficult to discern depending on the lens used, shooting conditions, etc.
- See page 211 regarding the correction data for Digital Lens Optimizer.

## Resizing JPEG Images

You can resize a JPEG image to make the pixel count lower and save it as a new image. Resizing an image is possible only with JPEG L, M, S1, and S2 images. JPEG S3 images, RAW images, and frame-grab images from 4K movies saved as still photos cannot be resized.

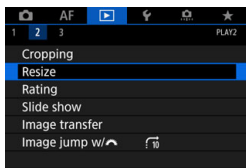

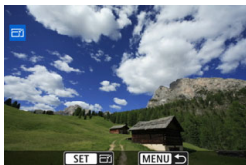

### 1 Select [Resize].

- Under the [] 2 tab, select [Resize], then press <SET>.
- ▶ An image is displayed.



### 2 Select the images to be resized.

- Turn the < > dial to select the image you want to resize.
- If you press the <Q> button and turn the < > dial counterclockwise, you can select an image from the index display.



### 3 Select the desired image size.

- Press <SET> to display the image sizes.
- Select the desired image size, then press <SET>.

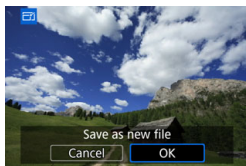

### 4 Save the image.

- Select [OK] to save the resized image.
- Check the destination folder and image file number, then select [OK].
- To resize another image, repeat steps 2 to 4.

## Resize Options by Original Image Quality

Original Image Quality	Available Resize Settings			
	M	S1	S2	S3
L	<input type="radio"/>	<input type="radio"/>	<input type="radio"/>	<input type="radio"/>
M	<input type="checkbox"/>	<input type="radio"/>	<input type="radio"/>	<input type="radio"/>
S1	<input type="checkbox"/>	<input type="checkbox"/>	<input type="radio"/>	<input type="radio"/>
S2	<input type="checkbox"/>	<input type="checkbox"/>	<input type="checkbox"/>	<input type="radio"/>

## Image Sizes

Sizes for resized images are shown below.

(Approx.)

Image Quality	Full-frame (3:2)	4:3 (aspect ratio)
M	4464x2976 (13.3 megapixels)	3968x2976 (11.8 megapixels)
S1	3360x2240 (7.5 megapixels)	*2976x2240 (6.7 megapixels)
S2	1920x1280 (2.5 megapixels)	*1696x1280 (2.2 megapixels)
S3	720x480 (350,000 pixels)	640x480 (310,000 pixels)

Image Quality	16:9 (aspect ratio)	1:1 (aspect ratio)
M	*4464x2512 (11.2 megapixels)	2976x2976 (8.9 megapixels)
S1	*3360x1888 (6.3 megapixels)	2240x2240 (5.0 megapixels)
S2	1920x1080 (2.1 megapixels)	1280x1280 (1.6 megapixels)
S3	*720x408 (290,000 pixels)	480x480 (230,000 pixels)



- The actual aspect ratio of images in the sizes marked with an asterisk may differ slightly from the aspect ratio indicated.
- The image may be cropped slightly depending on the resizing conditions.

## ✂ Cropping JPEG Images

You can crop a captured JPEG image and save it as another image. Cropping an image is possible only with JPEG L, M, S1, and S2 images. Images shot in JPEG S3 or RAW, and frame-grab images from 4K movies saved as still photos cannot be cropped.

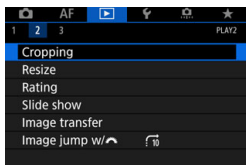

### 1 Select [Cropping].

- Under the [▶] 2 tab, select [Cropping], then press <SET>.
- ▶ An image is displayed.

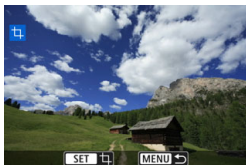

### 2 Select an image.

- Turn the <◉> dial to select the image you want to crop.
- If you press the <Q> button and turn the <☀> dial counterclockwise, you can select an image from the index display.



### 3 Set the cropping frame size, aspect ratio, position, and orientation.

- Press <SET> to display the cropping frame.
- The image area within the cropping frame will be cropped.

#### • Changing the Cropping Frame Size

Turn the <☀> dial to change the cropping frame size. The smaller the cropping frame, the more magnified the cropped image will look.

#### • Changing the Aspect Ratio

Turn the <◉> dial to change the cropping frame's aspect ratio. You can select the aspect ratio as follows: [3:2], [16:9], [4:3], or [1:1].

● **Moving the Cropping Frame**

Use <⊗> to move the frame over the image vertically or horizontally. Move the cropping frame until it covers the desired image area.

● **Switching the Cropping Frame Orientation**

Pressing the <INFO.> button will toggle the cropping frame between the vertical and horizontal orientations. This enables you to crop the image shot in horizontal orientation to look as if it was shot in vertical orientation.



**4 Check the image area to be cropped.**

- Press the <Q> button.
- ▶ The image area to be cropped will be displayed.
- Press the <Q> button again to return to the original image.

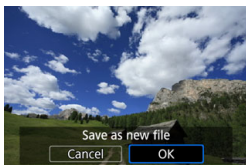

**5 Save the cropped image.**

- Press <SET> and select [OK] to save the cropped image.
- Check the destination folder and image file number, then select [OK].
- To crop another image, repeat steps 2 to 5.



- Once a cropped image is saved, it cannot be cropped again or resized.
- AF point display information (p.402) and Dust Delete Data (p.460) will not be appended to the cropped images.





# 12

## Sensor Cleaning

The camera has a Self Cleaning Sensor Unit to automatically shake off dust adhered to the image sensor's front layer (low-pass filter).

The Dust Delete Data can also be appended to the image so that the dust spots remaining can be deleted automatically by Digital Photo Professional (EOS software, p.598).

### **Smudges adhering to the front of the sensor**

Besides dust entering the camera from outside, in rare cases, lubricant from the camera's internal parts may adhere to the front of the sensor. If visible spots still remain after the automatic sensor cleaning, having the sensor cleaned by a Canon Service Center is recommended.

## Automatic Sensor Cleaning

Whenever you set the power switch to <ON> or <OFF>, the Self Cleaning Sensor Unit is activated to automatically shake off any dust on the front of the sensor. Normally, you need not pay attention to this operation. However, you can manually perform sensor cleaning or can disable this unit as follows.

### Activating the Sensor Cleaning Manually

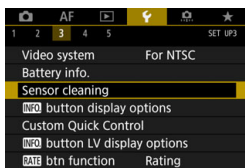

#### 1 Select [Sensor cleaning].

- Under the [ 3] tab, select [**Sensor cleaning**], then press <SET>.

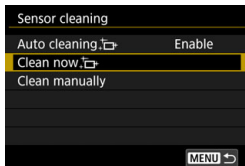



#### 2 Select [Clean now ].

- Select [**Clean now ** ], then press <SET>.
- Select [**OK**].

- ▶ The screen will indicate that the sensor is being cleaned. (A small sound may be heard.) Although there will be a mechanical sound of the shutter during sensor cleaning, the picture will not be recorded to the card.
- ▶ After sensor cleaning is finished, the camera will automatically restart (turn off and on).



- For best results, perform the sensor cleaning with the camera placed upright and stable on a table or other flat surface.
- Even if you repeat the sensor cleaning, the result will not improve much. Immediately after the sensor cleaning is finished, the [Clean now ] option remains disabled temporarily.
- Dots of light may appear on images if the sensor is affected by cosmic rays, etc. By selecting [Clean now ], their appearance may be suppressed (p.571).

## Disabling Automatic Sensor Cleaning

- In step 2, select [Auto cleaning ] and set it to [Disable].
- ▶ The sensor will no longer be cleaned when you set the power switch to <ON> or <OFF>.

## MENU Appending Dust Delete Data ☆

Normally, the Self Cleaning Sensor Unit will eliminate most of the dust that may be visible on captured images. However, for the case where visible dust still remains, you can append the Dust Delete Data to the image for erasing the dust spots later. The Dust Delete Data is used by Digital Photo Professional (EOS software, p.598) to erase the dust spots automatically.

### Preparation

- Prepare a solid white object such as a sheet of paper.
- Set the lens focal length to 50 mm or longer.
- Set the lens's focus mode switch to <MF> and set the focus to infinity ( $\infty$ ). If the lens has no distance scale, rotate the camera to face toward you and turn the focusing ring clockwise all the way.

### Obtaining the Dust Delete Data

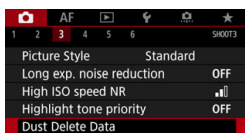

#### 1 Select [Dust Delete Data].

- Under the [**3**] tab, select [**Dust Delete Data**], then press <SET>.

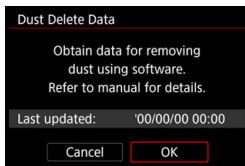

#### 2 Select [OK].

- ▶ After the automatic self-cleaning of the sensor is performed, a message will appear. Although there will be a mechanical sound of the shutter during the cleaning, no picture is taken.

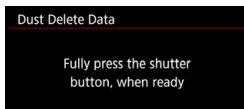
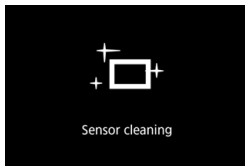



### 3 Shoot a solid-white object.

- At a distance of 20 cm - 30 cm (0.7 ft. - 1.0 ft.), fill the viewfinder with a patternless, solid-white object and take a picture.
- ▶ The picture will be taken in aperture-priority AE mode at an aperture of f/22.
- Since the image will not be saved, the data can still be obtained even if there is no card in the camera.
- ▶ When the picture is taken, the camera will start collecting the Dust Delete Data. When the Dust Delete Data is obtained, a message will appear.
- If the data is not obtained successfully, an error message will appear. Follow the "Preparation" procedure on the preceding page, then select [OK]. Take the picture again.

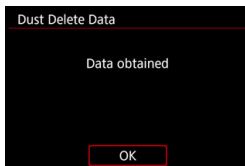

## Dust Delete Data

After the Dust Delete Data is obtained, it is appended to all the JPEG and RAW images captured thereafter. Before an important shoot, it is recommended that you update the Dust Delete Data by obtaining it again.

For details about using Digital Photo Professional (EOS software, p.598) to erase dust spots, refer to the Digital Photo Professional Instruction Manual (p.600).

The Dust Delete Data appended to the image is so small that it hardly affects the image file size.

 Be sure to use a solid-white object such as a new sheet of white paper. If the object has any pattern or design, it may be recognized as dust data and affect the accuracy of the dust deletion with the Digital Photo Professional (EOS software).

## MENU Manual Sensor Cleaning<sup>☆</sup>

Dust that could not be removed by the automatic sensor cleaning can be removed manually with a commercially-available blower, etc. Before cleaning the sensor, detach the lens from the camera.

**The image sensor is extremely delicate. If the sensor needs to be cleaned directly, having it done by a Canon Service Center is recommended.**

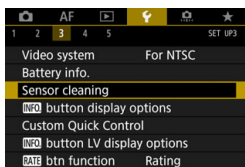

### 1 Select [Sensor cleaning].

- Under the [**3**] tab, select [Sensor cleaning], then press <SET>.

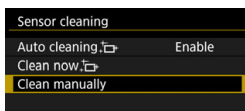

### 2 Select [Clean manually].



### 3 Select [OK].

- In a moment, the reflex mirror will lock up and the shutter will open.
- "CLn" will blink on the LCD panel.

### 4 Clean the sensor.

### 5 End the cleaning.

- Set the power switch to <OFF>.



If you will clean the sensor manually, make sure to use a fully-charged battery.



Using the household power outlet accessories (sold separately, p.530) is recommended.

- **While cleaning the sensor, never do any of the following. If the power is cut off, the shutter will close and the reflex mirror will go back down. These may result in damaging the image sensor, shutter curtains, and reflex mirror.**
  - **Setting the power switch to <OFF>.**
  - **Removing or inserting the battery.**
- The surface of the image sensor is extremely delicate. Clean the sensor with care.
- Use a plain blower without any brush attached. A brush can scratch the sensor.
- Do not insert the blower tip inside the camera beyond the lens mount. If the power is turned off, the shutter will close and the shutter curtains or reflex mirror may get damaged.
- Never use pressurized air or gas to clean the sensor. Pressurized air may damage the sensor, and sprayed gas may freeze on the sensor and scratch it.
- If the battery level becomes low while cleaning the sensor, the beeper will sound as a warning. Stop cleaning the sensor.
- If a smudge that cannot be removed with a blower remains, having the sensor cleaned by a Canon Service Center is recommended.



# 13

## Transferring Images to a Computer and Print Ordering

- **Transferring Images to a Computer** (p.466)  
You can connect the camera to a computer and operate the camera alone to transfer images recorded on the card to the computer.
- **Digital Print Order Format (DPOF)** (p.471)  
DPOF (Digital Print Order Format) enables you to print images recorded on the card according to your printing instructions such as the image selection, quantity to print, etc. You can print multiple images in one batch or create a print order for a photofinisher.
- **Specifying Images for a Photobook** (p.476)  
You can specify some of the images saved on the card for printing in a photobook.

## Transferring Images to a Computer

You can connect the camera to a computer and operate the camera to transfer images on the card to the computer. This is called direct image transfer.

**You can perform the direct image transfer with the camera while looking at the LCD monitor.**

The images transferred to the computer will be saved in the [Pictures] or [My Pictures] folder and organized in folders by shooting date.

 **Before connecting the camera to a computer, install EOS Utility (EOS software, p.598) to your computer (p.599).**

### Preparing Image Transfer

**1 Set the camera's power switch to <OFF>.**

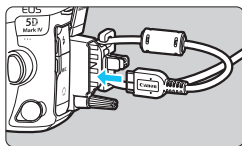

**2 Connect the camera to a computer.**

- Use the interface cable provided with the camera.
- When connecting the cable to the camera, use the cable protector (p.38). Connect the cable to the digital terminal with the plug's <SS<img alt="SS icon" data-bbox="455 665 475 685"/>>> icon facing the back of the camera.
- Connect the cord's plug to the computer's USB terminal.

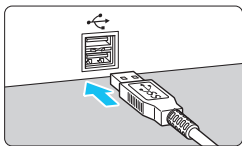

 Use the provided interface cable or one from Canon (p.525). When connecting the interface cable, use the provided cable protector (p.38).

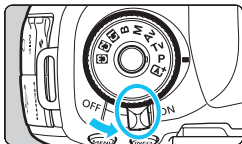

### 3 Set the power switch to <ON>.

- When the computer displays a screen to select the program, select [**EOS Utility**].
- ▶ The EOS Utility screen will appear on the computer.

⚠ **After the EOS Utility screen appears, do not operate EOS Utility.** If any screen other than EOS Utility's main window is displayed, [**Direct transfer**] in step 5 on page 469 will not be displayed. (You cannot transfer images to the computer.)

- 📖 ● If the EOS Utility screen does not appear, refer to the EOS Utility Instruction Manual (p.600).
- Before disconnecting the cable, turn off the camera. Hold the plug (not the cord) to pull out the cable.

## **MENU** Transferring RAW+JPEG Images

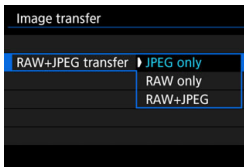

For RAW+JPEG images, you can specify which image to transfer.

On the next page in step 2, select [**RAW+JPEG transfer**], then select the image to be transferred: [**JPEG only**], [**RAW only**], or [**RAW+JPEG**].

⚠ This [**RAW+JPEG transfer**] setting is linked to the [**RAW+JPEG transfer**] setting under [**4: Communication settings**] → [**FTP transfer settings**] → [**Transfer type/size**], and the two will always remain synchronized.

## MENU Selecting the Images to be Transferred

### Selecting Images

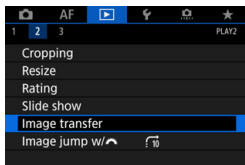

#### 1 Select [Image transfer].

- Under the [▶2] tab, select [Image transfer], then press <SET>.

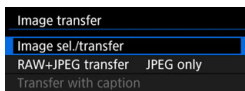

#### 2 Select [Image sel./transfer].

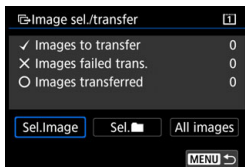

#### 3 Select [Sel.Image].

#### 4 Select the images to be transferred.

- Turn the <DISP> dial to select the image to be transferred, then press <SET>.
- Turn the <DISP> dial to display the [✓] on the upper left of the screen, then press <SET>.
- If you press the <Q> button and turn the <DISP> dial counterclockwise, you can select an image from a three-image display. To return to the single-image display, turn the <DISP> dial clockwise.
- To select another image to be transferred, repeat step 4.



- When [Sel.Image] is selected, you can check the image's transfer status on the upper left of the screen: No mark: Not selected. ✓: Selected for transfer. ×: Transfer failed. ○: Transfer succeeded.
- The procedures for [RAW+JPEG transfer] (p.467) and steps 1 to 4 above can also be performed even if the camera is not connected to a computer.

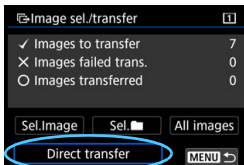

## 5 Transfer the image.

- On the computer screen, check that EOS Utility's main window is displayed.
- Select [**Direct transfer**], then press <SET>.
- On the confirmation dialog, select [**OK**] to transfer the images to the computer.
- Images selected with [**Sel. [Folder Icon]**] and [**All images**] can also be transferred in this way.

### ● Selecting [Folder Icon]

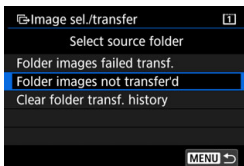

Select [**Sel. [Folder Icon]**] and select [**Folder images not transfer'd**]. When you select a folder, all the images in that folder not yet transferred to the computer will be selected.

Selecting [**Folder images failed transf.**] will select the selected folder's images that failed to transfer.

Selecting [**Clear folder transf. history**] will clear the transfer history of the images in the selected folder. After clearing the transfer history, you can select [**Folder images not transfer'd**] and transfer all the images in the folder again.

## ● All images

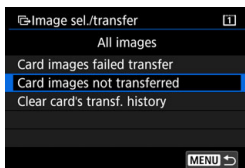

If [**All images**] is selected and you select [**Card images not transferred**], all the images on the card not yet transferred to a computer will be selected.

For a description of [**Card images failed transfer**] and [**Clear card's transf. history**], see “**Selecting**  ” on the preceding page.

- If any screen other than EOS Utility's main window is displayed on the computer, [**Direct transfer**] is not displayed.
- During the image transfer, certain menu options cannot be used.

- You can also transfer movies.
- Shooting is possible even during the image transfer.
- For [**Transfer with caption**] under [**▶2: Image transfer**], refer to the “Wi-Fi (Wireless Communication) Function Instruction Manual” (p.4).

# Digital Print Order Format (DPOF)

DPOF (Digital Print Order Format) enables you to print images recorded on the card according to your printing instructions such as the image selection, quantity to print, etc. You can print multiple images in one batch or create a print order for a photofinisher.

You can set the print settings such as print type, date imprinting, file number imprinting, etc. The print settings will be applied to all print-ordered images. (They cannot be set individually for each image.)

## Setting the Printing Options

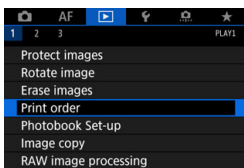

### 1 Select [Print order].

- Under the [**▶**1] tab, select [**Print order**], then press <SET>.

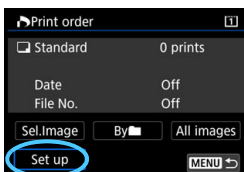

### 2 Select [Set up].

### 3 Set the options as desired.

- Set the [**Print type**], [**Date**], and [**File No.**].
- Select the option to be set, then press <SET>. Select the desired setting, then press <SET>.

#### Print type

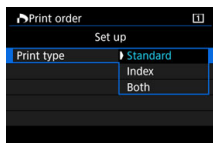



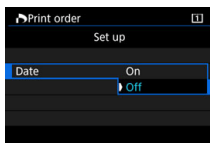

#### Date

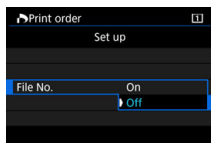

#### File No.



Print type		<b>Standard</b>	Prints one image on one sheet.
		<b>Index</b>	Multiple thumbnail images are printed on one sheet.
	 	<b>Both</b>	Prints both the standard and index prints.
Date	<b>On</b>	[On] imprints the recorded date of the captured image.	
	<b>Off</b>		
File number	<b>On</b>	[On] imprints the file number.	
	<b>Off</b>		

#### 4 Exit the setting.

- Press the <MENU> button.
- ▶ The print order screen will reappear.
- Next, select [**Sel.Image**], [**By** ], or [**All images**] to order the images to be printed.





- RAW images and movies cannot be print ordered.
- If you print an image with a large image size using the **[Index]** or **[Both]** setting (p.471), the index print may not be printed with certain printers. In such a case, resize the image (p.452), then print the index print.
- Even if **[Date]** and **[File No.]** are set to **[On]**, the date or file number may not be imprinted, depending on the print type setting and printer.
- With **[Index]** prints, the **[Date]** and **[File No.]** cannot both be set to **[On]** at the same time.
- When printing with DPOF, use the card whose print order specifications are set. It cannot be printed with the specified print order if you extract just the images from the card for printing.
- Certain DPOF-compliant printers and photofinishers may not be able to print the images as you specified. Refer to the printer's Instruction Manual before printing, or check with your photofinisher about compatibility when ordering prints.
- Do not specify a new print order for a card containing images whose print order was set by a different camera. All the print orders may be overwritten inadvertently. Also, the print order may not be possible, depending on the image type.



You can send images via Wi-Fi to a PictBridge-compatible (Wireless LAN) printer and print the images (direct printing). For details, refer to “Wi-Fi (Wireless Communication) Function Instruction Manual” (p.4).

## Specifying Images for Printing

### Selecting Images

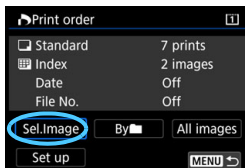

Select and order images one by one. If you press the <Q> button and turn the <⚙> dial counterclockwise, you can select an image from a three-image display. To return to the single-image display, turn the <⚙> dial clockwise. Press the <MENU> button to save the print order to the card.

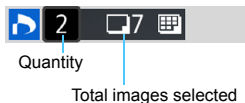

#### Standard / Both

Press <SET> to print a copy of the displayed image. By turning the <⚙> dial, you can set the number of copies to be printed up to 99.



#### Index

Press <SET> to add a checkmark to the box [✓]. The image will be included in the index print.

### By

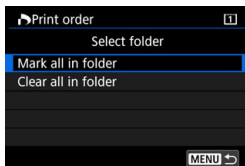

Select [**Mark all in folder**] and select the folder. A print order for one copy of all the images in the folder will be specified. If you select [**Clear all in folder**] and select the folder, the print order for all the images in the folder will be canceled.

## ● All images

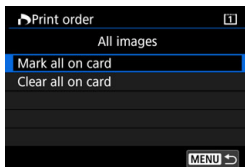

If you select [**Mark all on card**], one copy of all the images on the card will be set for printing.

If you select [**Clear all on card**], the print order will be cleared for all the images on the card.



- Note that RAW images and movies will not be included in the print order even if you set [**By [ ]**] or [**All images**].
- When using a PictBridge-compatible printer (Wireless LAN), do not specify more than 400 images for one print order. If you specify more than this, the images may not all be printed.



## Specifying Images for a Photobook

You can specify up to 998 images to be printed in a photobook. When you use EOS Utility (EOS software) to transfer images to a computer, the specified images will be copied to a dedicated folder. This function is useful for ordering photobooks online.

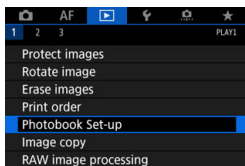
### Specifying One Image at a Time



#### 1 Select [Photobook Set-up].

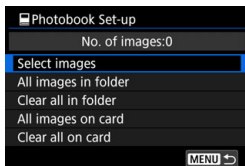

- Under the [] 1 tab, select [Photobook Set-up], then press < >.

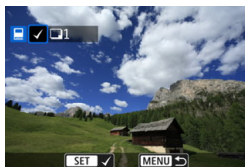

#### 2 Select [Select images].



#### 3 Select the image to be specified.

- Turn the < > dial to select the image to be specified, then press < >.
- If you press the <Q> button and turn the < > dial counterclockwise, you can select an image from a three-image display. To return to the single-image display, turn the dial clockwise.
- To select other images to be transferred, repeat step 3.

## Specifying All Images in a Folder or on a Card

You can specify all the images in a folder or on a card at once.

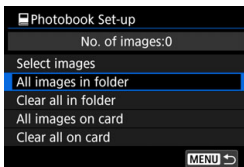

When [**▶ 1: Photobook Set-up**] is set to [**All images in folder**] or [**All images on card**], all the images in the folder or on the card will be specified.

To clear your selections, select [**Clear all in folder**] or [**Clear all on card**].



- RAW images and movies cannot be specified.
- Do not specify images already specified for a photobook in another camera for another photobook with this camera. The photobook settings may be overwritten.



# 14

## Customizing the Camera

You can make fine adjustments to various camera functions and change the functionality of buttons and dials to suit your picture-taking preferences with Custom Functions and Custom Controls.

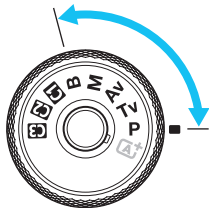

You can also save the camera's current settings to the <C1>, <C2>, and <C3> modes.

Note that the features explained in this chapter can be set and work in the following shooting modes: <P>, <Tv>, <Av>, <M>, and <B>.



# MENU Custom Functions ☆

## ☛.1: Exposure

		 LV Shooting	 Movie Shooting
Exposure level increments	p.482	<input type="radio"/>	<input type="radio"/>
ISO speed setting increments		<input type="radio"/>	In M
Bracketing auto cancel	p.483	<input type="radio"/>	
Bracketing sequence		<input type="radio"/>	
Number of bracketed shots	p.484	<input type="radio"/>	
Safety shift	p.485	<input type="radio"/>	
Same exposure for new aperture	p.486	<input type="radio"/>	

## ☛.2: Exposure

Set shutter speed range	p.488	<input type="radio"/>	<input type="radio"/>
Set aperture range		<input type="radio"/>	<input type="radio"/>

 Shaded Custom Functions do not function during Live View (LV) shooting or movie shooting. (Settings are disabled.)



### ☑.3: Display/Operation

		📷 LV Shooting	🎬 Movie Shooting
Warnings  in viewfinder	p.489		
LV shooting area display	p.490	<input type="radio"/>	
Dial direction during Tv/Av		<input type="radio"/>	<input type="radio"/>
Custom Controls		Depends on setting	

### ☑.4: Others

Add cropping information	p.491	<input type="radio"/>	
Default Erase option	p.492	(During playback)	
Retract lens on power off		<input type="radio"/>	<input type="radio"/>
Add IPTC information	p.493	<input type="radio"/>	

### ☑.5: Clear

Selecting [**☑.5: Clear all Custom Func. (C.Fn)**] will clear all the Custom Function settings.

 Even if [**☑.5: Clear all Custom Func.(C.Fn)**] is performed, the settings for [**☑.3: Custom Controls**] will remain unchanged. Also, although the [**☑.4: Add IPTC information**] will be retained, the setting will change to [**Disable**].

## MENU Custom Function Settings ☆

1	2	3	4	5	C.Fn1: Exposure
Exposure level increments					1/3
ISO speed setting increments					1/3
Bracketing auto cancel					ON
Bracketing sequence					0-+
Number of bracketed shots					3
Safety shift					OFF
Same expo. for new aperture					OFF

Under the [] tab, you can customize various camera features to suit your picture-taking preferences. Any settings different from the default will be displayed in blue.

### C.Fn1: Exposure

#### Exposure level increments

C.Fn1

##### 1/3: 1/3-stop

##### 1/2: 1/2-stop

Sets 1/2-stop increments for the shutter speed, aperture, exposure compensation, AEB, flash exposure compensation, etc.

When [**1/2-stop**] is set, the exposure level will be displayed as shown below.



#### ISO speed setting increments

C.Fn1

##### 1/3: 1/3-stop

##### 1/1: 1-stop

You can change the manual ISO speed setting increments to a whole-stop.

- 
- Even if [**1-stop**] is set, ISO speed will be automatically set in 1/3-stop increments when ISO Auto is set.
  - Even when [**1-stop**] is set, you can set ISO 32000.

## Bracketing auto cancel

C.Fn1

**ON: Enable**

When you set the power switch to **<OFF>**, the AEB and white balance bracketing settings will be canceled. AEB settings will also be canceled when the flash is ready to fire or if you switch to movie shooting.

**OFF: Disable**

The AEB and white balance bracketing settings will not be canceled even if you set the power switch to **<OFF>**. (If the flash is ready to fire or if you switch to movie shooting, AEB will be canceled temporarily, but the AEB range will be retained.)

## Bracketing sequence

C.Fn1

The AEB shooting sequence and white balance bracketing sequence can be changed.

**0-+:** 0, -, +

**-0+:** -, 0, +

**+0-:** +, 0, -

AEB	White Balance Bracketing	
	B/A Direction	M/G Direction
0 : Standard exposure	0 : Standard white balance	0 : Standard white balance
- : Decreased exposure	- : Blue bias	- : Magenta bias
+ : Increased exposure	+ : Amber bias	+ : Green bias

## Number of bracketed shots

C.Fn1

The number of shots taken with AEB and white balance bracketing can be changed from the default 3 shots, to 2, 5, or 7 shots.

When [**1: Bracketing sequence**] is set to [0, -, +], the bracketed shots will be taken as shown in the table below.

**3: 3 shots****5: 5 shots****2: 2 shots****7: 7 shots**

(1-stop/step increments)

	1st Shot	2nd Shot	3rd Shot	4th Shot	5th Shot	6th Shot	7th Shot
3: 3 shots	Standard (0)	-1	+1				
2: 2 shots	Standard (0)	±1					
5: 5 shots	Standard (0)	-2	-1	+1	+2		
7: 7 shots	Standard (0)	-3	-2	-1	+1	+2	+3

 If [2 shots] is set, you can select the + or - side when setting the AEB range. With WB bracketing, the 2nd shot will be adjusted towards either the B/A or M/G direction.

## Safety shift

C.Fn1

### OFF: Disable

#### Tv/Av: Shutter speed/Aperture

Takes effect in the <Tv> shutter-priority AE and <Av> aperture-priority AE modes. If the subject brightness changes and the standard exposure cannot be obtained within the autoexposure range, the camera will automatically change the manually-selected setting to obtain the standard exposure.

#### ISO: ISO speed

Works in the <P> Program AE, <Tv> shutter-priority AE, and <Av> aperture-priority AE modes. If the subject brightness changes and the standard exposure cannot be obtained within the autoexposure range, the camera will automatically change the manually set ISO speed to obtain the standard exposure.



- When [ISO speed] is set, safety shift will also work with AEB shooting in the <M> mode.
- Under [CAMERA 2: ISO speed settings], even if [Range for stills] or [Min. shutter spd.] is changed from the default setting, safety shift will override it if the standard exposure cannot be obtained.
- The minimum and maximum ISO speeds of the safety shift using the ISO speed will be determined by the [Auto range] setting (p.181). However, if the manually set ISO speed exceeds the [Auto range], the safety shift will take effect up or down to the manually set ISO speed.
- Safety shift will take effect if necessary even when flash is used.

## Same exposure for new aperture

C.Fn1

If the <M> mode (manual exposure shooting) is set and the ISO speed is set manually (except when set to ISO Auto), the open aperture value may change to a higher number (a smaller aperture) if you perform any of the following: 1. Change the lens, 2. Attach an extender, or 3. Use a zoom lens whose open aperture value (f/number) changes. If you then shoot while the maximum aperture is set, the image will be underexposed by the amount the maximum aperture f/number changes to a higher number. However, by changing the ISO speed or shutter speed (Tv) automatically, you can obtain the same exposure that would be obtained without performing 1, 2, or 3.

### OFF: Disable

Automatic changes in settings to maintain the specified exposure will not be applied. The ISO speed, shutter speed, and aperture already set will be used for shooting. If you perform 1, 2, or 3 and the maximum aperture becomes slower, adjust the ISO speed and shutter speed before you shoot.

### ISO: ISO speed

If you perform 1, 2, or 3, a higher ISO speed will be set automatically to compensate for the number of stops the maximum aperture has become slower. The same exposure that would be obtained without performing 1, 2, or 3 is thereby obtained. The ISO speed will change automatically within the range set with **[Range for stills]**.

### ISO/Tv: ISO speed/Shutter speed

If you perform 1, 2, or 3, a higher ISO speed will be set automatically to compensate for the number of stops the maximum aperture has become slower. If the ISO speed reaches the upper limit of the range set with **[Range for stills]**, a slower shutter speed will be set automatically. The same exposure that would be obtained without performing 1, 2, or 3 is thereby obtained. The shutter speed will change automatically within the range set with **[2: Set shutter speed range]**.

## Tv: Shutter speed

If you perform 1, 2, or 3, a slower shutter speed will automatically be set to compensate for the number of stops the maximum aperture has become slower. The same exposure that would be obtained without performing 1, 2, or 3 is thereby obtained. The shutter speed will change automatically within the range set with [**2: Set shutter speed range**].

This function also works in the reverse with the above options: When the maximum aperture f/number changes to a smaller number (larger aperture opening).



- This function does not work with macro lenses whose effective aperture value changes when the magnification changes.
- This function does not work during movie shooting.
- If [**ISO speed**] is set and the exposure cannot be maintained within the range set with [**Range for stills**], the same exposure that would be obtained without performing 1, 2, or 3 cannot be obtained.
- If [**Shutter speed**] is set and the exposure cannot be maintained within the range set with [**2: Set shutter speed range**], the same exposure that would be obtained without performing 1, 2, or 3 cannot be obtained.
- If you perform 1, 2, or 3 and the camera turns off (power switch is set to <OFF>, etc.) while the exposure is being maintained, the standard exposure will be updated to the exposure at the moment the camera turns off.



- This function also works with changes in the highest f/number (minimum aperture).
- With [**ISO speed**] or [**Shutter speed**] set, if you perform 1, 2, or 3 and then return to the state before performing 1, 2, or 3 without manually changing the ISO speed, shutter speed, or aperture, the original exposure setting will be restored.
- If [**ISO speed**] is set and the ISO speed increases to an expanded ISO speed, the shutter speed may change to maintain the exposure.

## C.Fn2: Exposure

### Set shutter speed range

C.Fn2

You can set the shutter speed range. In the <**Tv**> and <**M**> modes, you can set the shutter speed manually within the range you have set. In the <**P**> and <**Av**> modes, the shutter speed will be set automatically within the set shutter speed range (except for movie shooting). Then select [**OK**] to register the setting.

#### Highest speed

You can set it from 1/8000 sec. to 15 sec.

#### Lowest speed

You can set it from 30 sec. to 1/4000 sec.

### Set aperture range

C.Fn2

You can set the aperture range. In the <**Av**>, <**M**>, and <**B**> modes, you can set the aperture manually within the range you have set. (In the <**B**> mode, aperture cannot be set manually during movie shooting.) In the <**P**> and <**Tv**> modes, the aperture will be set automatically within the set aperture range (except for movie shooting). Then select [**OK**] to register the setting.

#### Min. aperture (Max. f/)

You can set it from f/91 to f/1.4.

#### Max. aperture (Min. f/)

You can set it from f/1.0 to f/64.

 The settable aperture range varies depending on the lens's maximum and minimum apertures.



## C.Fn3: Disp./Operation

### Warnings in viewfinder

C.Fn3

When any of the following functions are set, the  icon can be displayed in the viewfinder and on the LCD panel (p.31).

Select the function for which you want the warning icon to appear, then press  to add a checkmark [✓]. Then select [OK] to register the setting.

#### When monochrome is set

If the Picture Style is set to [Monochrome] (p.185), the warning icon will appear.

#### When WB is corrected

If white balance correction is set (p.198), the warning icon will appear.

#### When one-touch image quality is set

If you change the image-recording quality with the one-touch image quality setting function (p.507), the warning icon will appear.

#### When is set

If [CAMERA: High ISO speed NR] is set to [Multi Shot Noise Reduction] (p.202), the warning icon will appear.

#### When HDR is set

If [CAMERA: HDR mode] is set (p.263), the warning icon will appear.



If you set any of the checkmarked [✓] functions,  will also appear for the respective setting displayed on the Quick Control screen (p.64) and Custom Quick Control screen (p.510).

## Live View shooting area display

C.Fn3

When the aspect ratio (p.310) for Live View shooting is set to **[4:3]**, **[16:9]**, or **[1:1]**, you can set the display method for the image area.

 : **Masked**

 : **Outlined**





## Dial direction during Tv/Av

C.Fn3

 : **Normal**

 : **Reverse direction**

Dial turning direction when setting the shutter speed and aperture can be reversed.

In the **<M>** shooting mode, the turning direction of the  and  dials will be reversed. In other shooting modes, the turning direction of only the  dial will be reversed. The  dial's turning direction in the **<M>** mode and the turning direction to set the exposure compensation in the **<P>**, **<Tv>**, and **<Av>** mode will be the same.

## Custom Controls

C.Fn3

You can assign often-used functions to camera buttons or dials according to your preferences. For details, see page 495.

## C.Fn4: Others

## Add cropping information

C.Fn4

If you set the cropping information, vertical lines for the aspect ratio you set during the Live View shooting will be displayed on the screen. You can then compose the shot as if you were shooting with a medium- or large-format camera (6x6 cm, 4x5 inch, etc.).

When you take a picture, the aspect ratio information for cropping the image with the Digital Photo Professional (EOS software, p.598) will be appended to the image. (The image is recorded to the card without being cropped.)

If you transfer the image to a computer, you can use Digital Photo Professional to easily crop the image to the aspect ratio that was set at the time of shooting.

**OFF : Off****6:7 :Aspect ratio 6:7****6:6 : Aspect ratio 6:6****5:6 :Aspect ratio 10:12****3:4 : Aspect ratio 3:4****5:7 :Aspect ratio 5:7****4:5 : Aspect ratio 4:5**

- If [**5: Aspect ratio**] is set to any setting other than [**3:2**], you cannot set cropping information for the image.
- Cropping information will also be appended in viewfinder shooting. However, the cropping range will not be displayed.
- Even if a RAW image with cropping information added is processed with the camera (p.446), the JPEG image cannot be saved as a cropped image. When the RAW image is processed, the JPEG image with cropping information will be saved.

## Default Erase option

C.Fn4

During image playback and image review immediately after shooting, when you press the <  > button, the erase menu appears (p.439). You can set which option, **[Cancel]** or **[Erase]**, is to be preselected on this screen.

If **[Erase]** is set, you can just press <  > to quickly erase the image.

 : **[Cancel]** selected

 : **[Erase]** selected



If **[Erase]** is set, be careful not to erase an image accidentally.

## Retract lens on power off

C.Fn4

This is to set the lens retraction mechanism for when a gear-driven STM lens (such as EF40mm f/2.8 STM) is attached to the camera. You can set it to retract the extended lens automatically when the camera's power switch is set to < **OFF** >.

**ON** : Enable

**OFF**: Disable



- With auto power off, the lens will not retract regardless of the setting.
- Before detaching the lens, make sure that it is retracted.



When **[Enable]** is set, this function takes effect regardless of the lens's focus mode switch setting (AF or MF).

## Add IPTC information

C.Fn4

With the IPTC (International Press Telecommunications Council) information from EOS Utility (EOS software, p.598) registered to the camera, the IPTC information can be recorded (appended) to the still photos (JPEG/RAW images) you shoot. Useful for file management and other tasks utilizing the IPTC information.

**Regarding the procedure to register the IPTC information to the camera and details on registered information, refer to the EOS Utility Instruction Manual (p.600).**

### OFF: Disable

The IPTC information will not be recorded to the image.

### ON: Enable

During still photo shooting, the IPTC information registered in the camera will be recorded to the image.



The IPTC information is not appended during movie shooting (MOV or MP4 movies).



- During playback, you can check whether the IPTC information is appended or not (p.400).
- With Digital Photo Professional (EOS software, p.598), you can check the IPTC information recorded in the image.
- Even if [**5: Clear all Custom Func. (C.Fn)**] is selected (p.481), the IPTC information registered in the camera will not be erased. However, the setting will be [**Disable**].



# Custom Controls ☆

You can assign often-used functions to camera buttons or dials for ease of operation according to your preferences.

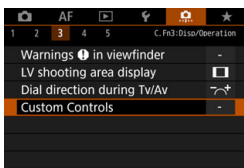

## 1 Select [Custom Controls].

- Under the [**3**] tab, select [**Custom Controls**], then press <SET>.
- ▶ The Custom Controls setting screen will appear.

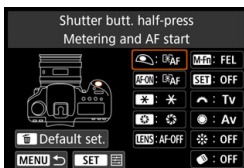

## 2 Select a camera button or dial.

- Select a camera button or dial, then press <SET>.
- ▶ The name of the camera control and the assignable functions will be displayed.
- ▶ The diagram on the left will show the location of the selected button or dial.



## 3 Assign a function.

- Select a function, then press <SET>.
- If the [**INFO**] icon appears on the bottom left of the screen, you can press the <INFO.> button and set other related options.

## 4 Exit the setting.





- When you press <SET> to exit the setting, the screen in step 2 will reappear.
- Press the <MENU> button to exit.

With the screen in step 2 displayed, you can press the <MENU> button to revert the Custom Control settings to their defaults. Note that the [**3: Custom Controls**] settings will not be canceled even if you select [**5: Clear all Custom Func. (C.Fn)**].

## Assignable Functions to Camera Controls





















Function		Page		AF-ON	
AF	AF Metering and AF start	500	<input type="radio"/>	<input type="radio"/> *1	<input type="radio"/> *1
	AF-OFF AF stop	501	<input type="checkbox"/>	<input type="radio"/>	<input type="radio"/>
	AF↔ Switch to registered AF function	502	<input type="checkbox"/>	<input type="checkbox"/>	<input type="checkbox"/>
	ONE SHOT ↔ AI SERVO/SERVO		<input type="radio"/> *3	<input type="radio"/> *3	
	HP Switch to registered AF point	503	<input type="checkbox"/>	<input type="checkbox"/>	<input type="checkbox"/>
	SEL HP Selected AF point ↔ Center/Registered AF point		<input type="checkbox"/>	<input type="checkbox"/>	<input type="checkbox"/>
	Direct AF point selection		<input type="checkbox"/>	<input type="checkbox"/>	<input type="checkbox"/>
	Direct AF area selection	504	<input type="checkbox"/>	<input type="checkbox"/>	<input type="checkbox"/>
Pause Movie Servo AF	<input type="checkbox"/>		<input type="checkbox"/>	<input type="checkbox"/>	
Exposure	Metering start	504	<input type="radio"/>	<input type="checkbox"/>	<input type="checkbox"/>
	AE lock		<input type="checkbox"/>	<input type="radio"/>	<input type="radio"/>
	AE lock (while button pressed)		<input type="radio"/>	<input type="checkbox"/>	<input type="checkbox"/>
	AE lock (hold)	505	<input type="checkbox"/>	<input type="radio"/>	<input type="radio"/>
	*AF-OFF AE lock, AF stop		<input type="checkbox"/>	<input type="radio"/>	<input type="radio"/>
	FEL FE lock		<input type="checkbox"/>	<input type="radio"/>	<input type="radio"/>
	ISO  Set ISO speed (hold button, turn )		<input type="checkbox"/>	<input type="checkbox"/>	<input type="checkbox"/>
	ISO  Set ISO speed (hold button, turn )		<input type="checkbox"/>	<input type="checkbox"/>	<input type="checkbox"/>
	ISO  Set ISO speed ( during metering)	506	<input type="checkbox"/>	<input type="checkbox"/>	<input type="checkbox"/>
	Exposure compensation (hold button, turn )		<input type="checkbox"/>	<input type="checkbox"/>	<input type="checkbox"/>
	Exposure compensation (hold button, turn )		<input type="checkbox"/>	<input type="checkbox"/>	<input type="checkbox"/>
Tv Shutter speed setting in M mode	<input type="checkbox"/>		<input type="checkbox"/>	<input type="checkbox"/>	
Av Aperture setting in M mode	<input type="checkbox"/>		<input type="checkbox"/>	<input type="checkbox"/>	







	LENS	M-Fn	SET				
	<input type="radio"/>						
<input type="radio"/>	<input type="radio"/>						
<input type="radio"/> *2	<input type="radio"/> *2						
<input type="radio"/> *3	<input type="radio"/> *3						
<input type="radio"/> *4	<input type="radio"/> *4						
							<input type="radio"/> *5
					<input type="radio"/> *6	<input type="radio"/> *7	
							<input type="radio"/>
<input type="radio"/>			<input type="radio"/>				
<input type="radio"/>	<input type="radio"/>	<input type="radio"/>					<input type="radio"/>
<input type="radio"/>	<input type="radio"/>	<input type="radio"/>					<input type="radio"/>
<input type="radio"/>		<input type="radio"/>					
			<input type="radio"/>				
							<input type="radio"/>
					<input type="radio"/>		
			<input type="radio"/>				
							<input type="radio"/>
				<input type="radio"/>	<input type="radio"/>		
				<input type="radio"/>	<input type="radio"/>		



<LENS> stands for "AF stop button" provided on super telephoto lenses equipped with Image Stabilizer.

Function		Page		AF-ON		
Images	 RAW JPEG	507				
	 RAW JPEG H					
	 Image quality					
	 Picture Style	508				
Operation	 Depth-of-field preview	508				
	 IS start					
	MENU		Menu display			
	 Register/recall shooting function			<input type="radio"/> *9	<input type="radio"/> *9	
	UNLOCK 	Unlock while button pressed	509			
	 Start movie recording (when  set)					
	 Image replay					
	 Magnify/Reduce (press SET, turn  )					
	 Cycle:  •  / DRIVE • AF / WB • 					
	 Flash function settings					
OFF	No function (disabled)		<input type="radio"/>	<input type="radio"/>		

 *8	LENS	M-Fn	SET				
<input type="radio"/> *8		<input type="radio"/> *8					
<input type="radio"/> *8		<input type="radio"/> *8					
			<input type="radio"/>				
			<input type="radio"/>				
<input type="radio"/>			<input type="radio"/>				
<input type="radio"/>	<input type="radio"/>						
			<input type="radio"/>				
<input type="radio"/>							
<input type="radio"/>		<input type="radio"/>	<input type="radio"/>				
			<input type="radio"/>				
			<input type="radio"/>				
		<input type="radio"/>					
			<input type="radio"/>				
<input type="radio"/>		<input type="radio"/>	<input type="radio"/>	<input type="radio"/>	<input type="radio"/>	<input type="radio"/>	<input type="radio"/>



<LENS> stands for "AF stop button" provided on super telephoto lenses equipped with Image Stabilizer.

## AF

## AF: Metering and AF start

When you press the button assigned to this function, metering and AF are performed.

\*1: When assigned to the <AF-ON> or <★> button, pressing the <INFO.> button while the setting screen is displayed will enable you to set the detailed AF settings. When shooting, pressing the <AF-ON> or <★> button will perform AF as it was set.

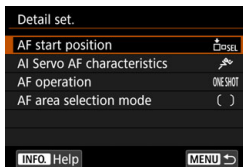

## ● AF start position

When [Registered AF point] is set, you can press the <AF-ON> or <★> button to switch to the registered AF point.

## Registering the AF Point

1. Set the AF area selection mode to one of the following: Single-point Spot AF (manual selection), Single-point AF (manual selection), AF point expansion (manual selection  $\text{⦿}$ ), AF point expansion (manual selection, surrounding points), or Automatic selection AF. Zone AF and Large Zone AF cannot be selected.
2. Select an AF point manually.
3. Hold down the <☐> button, then press the <⦿> button. A beep will sound, and the AF point will be registered, then the registered AF point will blink.



- When the AF point is registered, the following will be displayed:
  - Automatic selection AF: [ ] HP (HP: Home Position)
  - Single-point Spot AF (manual selection), Single-point AF (manual selection), AF point expansion (manual selection  $\text{⦿}$ ), AF point expansion (manual selection, surrounding points): SEL [ ] (Center), SEL HP (Off center)
- To cancel the registered AF point, hold down the <☐> button, then press the <ISO> button. The registered AF point will also be canceled if you select [5: Clear all camera settings].

- **AI Servo AF characteristics** (p.127)  
Press the <AF-ON> or <✳> button to perform AF with the set case from [Case 1] to [Case 6].
- **AF operation** (p.100)  
Press the <AF-ON> or <✳> button to perform AF with the set AF operation.
- **AF area selection mode** (p.104)  
Press the <AF-ON> or <✳> button to perform AF with the set AF area selection mode.

If you want to keep using the currently selected AF point when you press the <AF-ON> or <✳> button, set [AF start position] to [Manually selected AF point]. If you want to keep the currently set AI Servo AF characteristics, AF operation, and AF area selection mode, select [Maintain current setting].



- If [AF4: Orientation linked AF point] is set to [Separate AF pts: Area+pt] or [Separate AF pts: Pt only], you can separately register the AF points to be used for vertical (grip up or down) and horizontal shooting.
- If [Registered AF point] and [AF area selection mode] are both set for [AF start position], [Registered AF point] will take effect.

#### AF-OFF: AF stop

The AF will stop while you hold down the button assigned to this function. Useful when you want to stop the AF during AI Servo AF.

## AF-: Switch to registered AF function

Only while you hold down the depth-of-field preview button or the lens's AF stop button, you can apply AF with the following settings: AF area selection mode (p.104), Tracking sensitivity (p.132), Acceleration/ deceleration tracking (p.133), AF point auto switching (p.134), AI Servo 1st image priority (p.136), and AI Servo 2nd image priority (p.137). Useful when you want to change the AF characteristics during AI Servo AF.

\*2: On the setting screen, press the <INFO.> button to display the detailed settings screen. Turn the <◁> or <▷> dial to select the function to be registered, then press <SET> to add a checkmark [✓]. When you select a function and press <SET>, you can adjust the setting. By pressing the <⏏> button, you can revert the settings to their defaults.

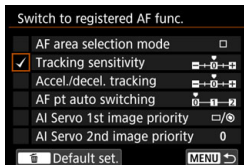

## ONESHOT/SERVO ↔ AI SERVO/SERVO

You can switch the AF operation. In One-Shot AF mode, when you press the button to which this function is assigned, the camera switches to AI Servo AF/Servo AF mode. If you press the button in the AI Servo AF/Servo AF mode, the camera switches to One-Shot AF mode. Useful when you need to keep switching between One-Shot AF and AI Servo AF/Servo AF for a subject that keeps moving and stopping.

\*3: On the setting screen, when you press the <INFO.> button, you can select [Switch only when btn is held] or [Switch each time btn is pressed].

ⓘ This function does not work during Live View shooting if Multi Shot Noise Reduction is set.

### : Switch to registered AF point

While the metering timer is active, when you press the depth-of-field preview button or the lens's AF stop button, the focusing point can be switched to the registered AF point.



- \*4: On the setting screen, when you press the <INFO.> button, you can select [**Switch only when btn is held**] or [**Switch each time btn is pressed**]. To register the AF point, see page 500.

### : Selected AF point ↔ Center/Registered AF point

While the metering timer is active, pressing the < > (AF area selection) button will switch between the current AF point and the center AF point or registered AF point.

- \*5: On the setting screen, when you press the <INFO.> button, you can select [**Switch to center AF point**] or [**Switch to registered AF point**]. To register the AF point, see page 500.



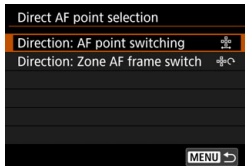

### : Direct AF point selection

While the metering timer is active, you can select an AF point directly with the < > or < > dial without pressing the < > button.



- \*6: With the Quick Control Dial setting screen displayed, you can press the <INFO.> button, then set the direction for switching the AF point for when the < > dial is turned. The [**Direction: AF point switching**] settings for [**Horizontal**] and [**Vertical**] will work for Single-point Spot AF, Single-point AF, Man. select.<sup>Ⓜ</sup>: AF point expansion, and Expand AF area: Surround. The [**Direction: Zone AF frame switch**] settings for [**Cycle through the zones**], [**Horizontal**], and [**Vertical**] will work with Zone AF.



- \*7: On the Multi-controller setting screen, you can press the <INFO.> button and select the AF point ([**Switch to center AF point**] or [**Switch to registered AF point**]) the camera switches to when you press the center of < >. To register the AF point, see page 500.

 If you assign [**Direct AF point selection**] to < > and you want to change the aperture in the <M> mode, hold down the < > button and turn the < > dial.

 : **Direct AF area selection**

If the metering timer is active, you can press the < > (AF area selection) button to directly select an AF area selection mode without pressing the < > button.

 : **Pause Movie Servo AF**

When Movie Servo AF is active, you can pause the AF by pressing the Depth-of-field preview button or < >. Press the button again to resume Movie Servo AF.

## Exposure

 : **Metering start**

When you press the shutter button halfway, exposure metering is performed (AF is not performed).

 : **AE lock**

When you press the button assigned to this function, you can lock the exposure (AE lock) while the metering timer is active. Useful when you want to focus and meter the shot separately.

 : **AE lock (while button pressed)**

The exposure will be locked (AE lock) while you hold down the shutter button.

 If you assign [**AE lock (while button pressed)**] to the shutter button, any buttons assigned to [**AE lock**] or [**AE lock (hold)**] will also work as [**AE lock (while button pressed)**].



**\*H: AE lock (hold)**



When you press the button assigned to this function, you can lock the exposure (AE lock). The AE lock will be maintained until you press the button again. Useful when you want to set the focus and meter separately or take multiple shots at the same exposure setting.



**\*AF-OFF: AE lock, AF stop**



When you press the button assigned to this function, you can lock the exposure (AE lock) and the AF will stop. Useful with AI Servo AF if you want to perform AE lock at the same time when AF stops.





**FEL: FE lock**

For flash photography, pressing the button assigned to this function will fire a preflash and record the required flash output (FE lock).

**ISO : Set ISO speed (hold button, turn )**



You can set the ISO speed by holding down < > and turning the < > dial (for still photo shooting only). If this control is used with ISO Auto set, you can set the ISO speed manually. When the metering timer () ends, ISO Auto will be restored. If you use this function in the <**M**> mode, you can adjust the exposure with the ISO speed while maintaining the current shutter speed and aperture value.



**ISO : Set ISO speed (hold button, turn )**

You can set the ISO speed by holding down < > (AF area selection) button and turning the < > dial (for still photo shooting only). The settable range is the same as with [**ISO : Set ISO speed (hold btn, turn **)]].







For movie shooting, setting [**ISO : Set ISO speed (hold btn, turn **)] or [**ISO : Set ISO speed (hold btn, turn **)] will not take effect.



**ISO : Set ISO speed (  during metering )**







While the metering timer is active, you can set the ISO speed by turning the < > dial. If this control is used with ISO Auto set, you can set the ISO speed manually. (Even after the metering timer ( 4 ) ends, ISO Auto will not be restored.) If you use this function in the <**M**> mode, you can adjust the exposure with the ISO speed while maintaining the current shutter speed and aperture value.

** : Exposure compensation (hold button, turn  )**



You can set the exposure compensation by holding down < > and turning the < > dial. Useful when you want to set exposure compensation in <**M**> manual exposure with ISO Auto set.

** : Exposure compensation (hold button, turn  )**



You can set the exposure compensation by holding down < > (AF area selection) button and turning the < > dial. Useful when you want to set exposure compensation in <**M**> manual exposure with ISO Auto set.

 The following will work even while the <LOCK▶> switch is set to the right (Multi function lock, p.62): [ : Set ISO speed (hold btn, turn  )] (p.505) and [ : Exposure compensation (hold btn, turn  )].

**Tv : Shutter speed setting in M mode**

In <**M**> manual exposure, you can set the shutter speed with the < > or < > dial.

**Av: Aperture setting in M mode**

In <**M**> manual exposure, you can set the aperture with the < > or < > dial.

## Images

### RAW / JPEG : One-touch image quality setting

Pressing the depth-of-field preview button or <M-Fn> button will switch to enable shooting with the image-recording quality set here. If [**Show/hide in viewfinder**] has [**Image quality**] checkmarked [✓] (p.84), the image-recording quality (JPEG or RAW image type) will blink in the viewfinder. After the shooting ends, the One-touch image quality setting will be canceled and the image-recording quality will be switched back to the previous quality.

\*8: On the setting screen, when you press the <INFO.> button, you can set the image-recording quality for this function.

### RAW / JPEG H: One-touch image quality (hold)

Pressing the depth-of-field preview button or <M-Fn> button will switch to enable shooting with the image-recording quality set here. If [**Show/hide in viewfinder**] has [**Image quality**] checkmarked [✓] (p.84), the image-recording quality (JPEG or RAW image type) will blink in the viewfinder. Even after shooting, the One-touch image quality setting will not be canceled. To revert to the previous image-recording quality setting, press the button assigned to this function again.

\*8: On the setting screen, when you press the <INFO.> button, you can set the image-recording quality for this function.

 If RAW or RAW+JPEG is set for the image-recording quality to be switched to with [**One-touch image quality setting**] or [**One-touch image quality (hold)**], [**Multi Shot Noise Reduction**] (p.202) will be canceled when switching is performed. For [**3: High ISO speed noise reduct'n**], [**Standard**] will be applied for shooting.

 You can set the camera to display <I> in the viewfinder and on the LCD panel for when the image-recording quality is switched with the One-touch image quality setting (p.489).

### : Image quality

Press <SET> to display the image-recording quality setting screen (p.169) on the LCD monitor.

## Picture Style

Press <> to display the Picture Style selection setting screen on the LCD monitor (p.183).

## Operation

### Depth-of-field preview

When you press the depth-of-field preview button or <>, the aperture will stop down and you can check the depth of field (p.250).

### IS start





If you press the depth-of-field preview button or the lens's AF stop button with the lens's IS switch set to <**ON**>, the lens's Image Stabilizer will be activated.

### MENU: Menu display

Press <> to display the menu on the LCD monitor.

### Register/recall shooting function

You can manually set the main shooting functions, such as the shutter speed, aperture, ISO speed, metering mode, and AF area selection mode, and can register them to the camera. Only while you hold down the <AF-ON> or <> button, you can recall and use the registered shooting function settings to take a picture.

\*9: On the setting screen, press the <**INFO.**> button to display the detailed settings. Turn the <> or <> dial to select the function to be registered, then press <> to add a checkmark [✓] to it. When you select a function and press <>, you can adjust the setting. By pressing the <> button, you can revert the settings to their defaults. By selecting [**Register current settings**], the camera's current settings will be registered. To register the AF point, see page 500.



**UNLOCK  : Unlock while button pressed**



Even when the <LOCK▶> switch is set to the right, as long as the depth-of-field preview button is held down, you can use the camera control buttons and dials restricted by [**5: Multi function lock**] (p.90).

** : Start movie recording (when  set)**



For movie shooting, pressing the button assigned to this function will start the movie shooting. To stop the movie shooting, press the button again.



** : Image replay**

Press <SET> to play back the images.

** : Magnify/Reduce (press SET, turn )**

Press <SET> to magnify or reduce the images recorded on the card (p.406). You can also magnify the image during Live View shooting and movie shooting (p.325, 329).

** : Cycle: •ISO/DRIVE•AF/WB•**

Pressing the <M-Fn> button changes the settable function in the following sequence: •ISO → DRIVE•AF → WB•.

** : Flash function settings**

Press <SET> to display the flash function setting screen (p.291).

**OFF: No function (disabled)**

Use this setting when you do not want to assign any function to the button.

# Custom Quick Control

On the standard Quick Control screen (p.64), preset shooting functions are displayed in the default layout. On the Custom Quick Control screen, you can customize the screen with your preferred shooting functions and layout. This feature is called “Custom Quick Control”. This page explains how to change the layout of the Custom Quick Control screen. Page 64 explains how to operate the Quick Control, and page 86 explains how to display the Custom Quick Control screen.

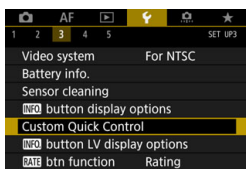

## 1 Select [Custom Quick Control].

- Under the [**⚡**3] tab, select [**Custom Quick Control**], then press <SET>.

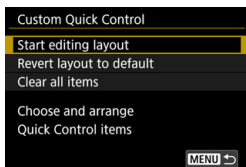

## 2 Select [Start editing layout].

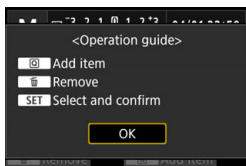

## 3 Read the operation procedure and select [OK].

- **+** : Add item
- **🗑** : Remove
- **SET** : Select and confirm



- Items displayed on the default screen are shown on the left.

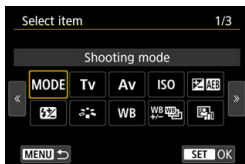

## 4 Add an item.

- Press the <Q> button.
- Turn the <DIAL> dial or use <MULTISELECT> to select the item to be added, then press <SET>.
- To remove an item, select the item, then press the <DELETE> button. Otherwise, select [**Clear all items**] in step 2.
- For items that let you select the icon size, turn the <DIAL> dial or use <MULTISELECT> to select the size, then press <SET>.
- For items which can be positioned and for display sizes, see page 513.



## 5 Position the item.

- Use <DIAL>, <DIAL> or <MULTISELECT> to move the item (framed with directional wedges) to the desired position.
- If you want to change the size, press the <INFO.> button to change it.
- Press <SET> to place the item. If there is already an item on that position, it will be overwritten (deleted).
- To change the position of an item, select the item, then press <SET> to move it.



If you first want to delete all the items displayed by default, select [**Clear all items**] in step 2, then go to step 4.

## Sample layout

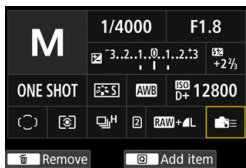

## Sample screen



- Repeat steps 4 and 5 to position other items as desired.
- To delete an item already in position, select it, then press the  $\langle \text{trash} \rangle$  button.

## 6 Exit the setting.

- Press the  $\langle \text{MENU} \rangle$  button to exit the setting. The screen in step 2 will reappear.

## 7 Check the setting screen.

- Under [**3: INFO** button display options], check that [**Custom Quick Control screen**] has a checkmark [ $\checkmark$ ] (p.86).
- Press the  $\langle \text{INFO} \rangle$  button to display the Custom Quick Control screen (p.86) and check the layout.
- Press the  $\langle \text{Q} \rangle$  button to use the Quick Control (p.64).

## Resetting the Custom Quick Control Screen or Clearing All Items

In step 2, selecting [**Revert layout to default**] will initialize the current setting and revert the Custom Quick Control screen to the default layout (p.510).

Selecting [**Clear all items**] will delete all the items set. The screen will then become blank with no items displayed except for the bottom line.



## Available Items and Display Sizes for the Screen Layout

(Vertical x horizontal cells)

Item and Size	1x1	1x2	1x3	1x5	2x2	2x3
Shooting mode	<input type="radio"/>				<input type="radio"/>	
Shutter speed	<input type="radio"/>	<input type="radio"/>				
Aperture	<input type="radio"/>	<input type="radio"/>				
ISO speed	<input type="radio"/>	<input type="radio"/>				
Exposure compensation/AEB setting	<input type="radio"/>	<input type="radio"/>	<input type="radio"/>			
Flash exposure compensation	<input type="radio"/>	<input type="radio"/>	<input type="radio"/>			
Picture Style	<input type="radio"/>		<input type="radio"/>			
White balance	<input type="radio"/>	<input type="radio"/>				
White balance shift/bracketing	<input type="radio"/>	<input type="radio"/>				
Auto Lighting Optimizer	<input type="radio"/>					
Custom Controls	<input type="radio"/>					
AF operation	<input type="radio"/>	<input type="radio"/>				
AF point selection	<input type="radio"/>					<input type="radio"/>
Metering mode	<input type="radio"/>					
Drive mode	<input type="radio"/>					
Recording function/card selection	<input type="radio"/>	<input type="radio"/>			<input type="radio"/>	
Date/Time/Zone	<input type="radio"/>	<input type="radio"/>		<input type="radio"/>		<input type="radio"/>
External Speedlite control	<input type="radio"/>					
Highlight tone priority	<input type="radio"/>					
Viewfinder grid	<input type="radio"/>					
Sensor cleaning	<input type="radio"/>					
GPS setting	<input type="radio"/>					
Anti-flicker shooting	<input type="radio"/>					
Long exposure noise reduction	<input type="radio"/>					
High ISO speed noise reduction	<input type="radio"/>					
Select folder		<input type="radio"/>				

- Depending on the items, the amount of displayable information and settable functions for Quick Control may vary due to their display sizes.
- The same item cannot be placed in multiple positions on the screen.
- In the <[A]<sup>+</sup>> mode, some menu items are not displayed. Also, some menu items cannot be set with the Quick Control.

## <[A]<sup>+</sup>> Mode Settings and Display Conditions

You can also set Custom Quick Control and display the Custom Quick Control screen in the <[A]<sup>+</sup>> mode.

However, functions such as [Expo.comp./AEB] that are not displayed on the menu screen for <[A]<sup>+</sup>> mode will not appear on the Custom Quick Control screen, even if those items are set to be displayed. Also, functions such as [ISO speed] that cannot be set with the Quick Control screen in the <[A]<sup>+</sup>> mode will be grayed out.

- **Not displayed**

Exposure compensation/AEB, Flash exposure compensation, White balance shift/bracketing, Custom Controls, External Speedlite control, Highlight tone priority, Anti-flicker shooting, Long exposure noise reduction, High ISO speed noise reduction

- **Grayed out** (not settable with the Quick Control screen)

Shutter speed, Aperture, ISO speed, Picture Style, White balance, Auto Lighting Optimizer, AF operation, AF point selection, Metering mode

## MENU Registering My Menu ☆

Under My Menu tab, you can register menu items and Custom Functions whose settings you change frequently. You can also name the registered menu tabs, and press the <MENU> button to display the My Menu tab first.

### Creating and Adding My Menu Tab

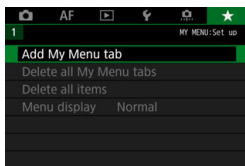

- 1 Select [Add My Menu tab].
  - Under the [★] tab, select [Add My Menu tab], then press <SET>.

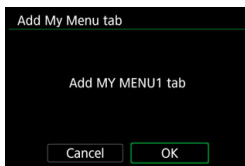

- 2 Select [OK].
  - ▶ The [MY MENU1] tab is created.
  - You can create up to five menu tabs by repeating steps 1 and 2.

### Registering Menu Items under the My Menu Tab(s)



- 1 Select [Configure: MY MENU\*].
  - Turn the <⚙️> dial to select [Configure: MY MENU\*] (tab for registering menu items), then press <SET>.

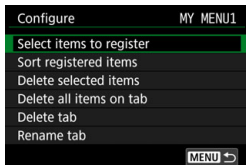

## 2 Select [Select items to register].

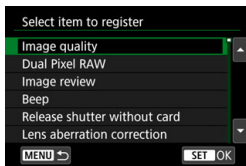

## 3 Register the desired items.

- Select the desired item, then press <SET>.
- Select [OK] on the confirmation dialog.
- You can register up to six items.
- To return to the screen in step 2, press the <MENU> button.

## My Menu Tab Settings

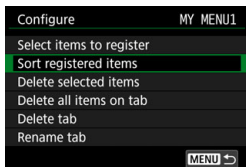

You can sort and delete items under the menu tab, and rename or delete the menu tab.

### • Sort registered items

You can change the order of the registered items in My Menu. Select [**Sort registered items**] and select the item whose order you want to change. Then press <SET>. With [◆] displayed, turn the <◉> dial to change the order, then press <SET>.

### • Delete selected items / Delete all items on tab

You can delete any of the registered items. [**Delete selected items**] deletes one item at a time, and [**Delete all items on tab**] deletes all the registered items under the tab.

● **Delete tab**

You can delete the My Menu tab currently displayed. Select [**Delete tab**] to delete the [MY MENU\*] tab.

● **Rename tab**

You can rename the My Menu tab from [MY MENU\*].

**1 Select [Rename tab].**

**2 Enter text.**

- Press the <🗑️> button to delete any unnecessary characters.
- Operate the <🕒>, <🌅>, or <🌑> to move the  and select the desired character. Then press <SET> to enter it.
- By selecting [Aa↔1@], you can change the input mode.
- You can enter up to 16 characters.
- To cancel the text entry, press the <INFO.> button, then select [OK].

**3 Exit the setting.**

- After entering the text, press the <MENU> button, then select [OK].
- ▶ The set name is saved.



Input mode



If you cannot enter text in step 2, press the <Q> button and use the character palette when the blue frame appears.

## Deleting all My Menu tabs / Deleting all items

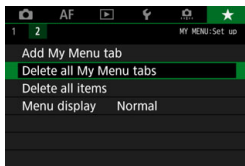

You can delete all My Menu tabs or all My Menu items that you created and registered under the tabs.

- **Delete all My Menu tabs**

You can delete all My Menu tabs you created. When you select **[Delete all My Menu tabs]**, all the tabs from **[MY MENU1]** to **[MY MENU5]** will be deleted and the **[★]** tab will revert to its default.

- **Delete all items**

You can delete only but all the items registered under the **[MY MENU1]** to **[MY MENU5]** tabs. The tab(s) will remain. When **[Delete all items]** is selected, all the items registered under all the created tabs will be deleted.

ⓘ If you perform **[Delete tab]** or **[Delete all My Menu tabs]**, tab names renamed with **[Rename tab]** will also be deleted.

## Menu Display Settings

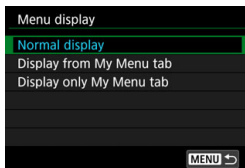

You can select [**Menu display**] to set the menu screen that is to appear first when you press the <MENU> button.

- **Normal display**  
Displays the last displayed menu screen.
- **Display from My Menu tab**  
Displays with the [★] tab selected.
- **Display only My Menu tab**  
Only the [★] tab is displayed. (The 📷, AF, ▶, 🗑️, and .📷 tabs will not be displayed.)

## **C1**: Registering Custom Shooting Modes ☆

You can register current camera settings, such as the shooting functions, menu functions, and Custom Function settings, as Custom shooting modes under the Mode Dial's <**C1**>, <**C2**>, and <**C3**> positions.

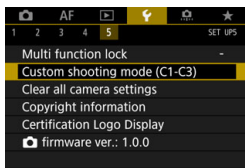

### **1** Select [Custom shooting mode (C1-C3)].

- Under the [**F5**] tab, select [**Custom shooting mode (C1-C3)**], then press <**SET**>.

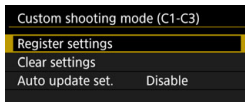

### **2** Select [Register settings].

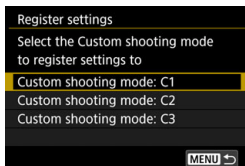

### **3** Register the desired items.

- Select the Custom shooting mode to be registered, then press <**SET**>.
- Select [**OK**] on the confirmation dialog.
- ▶ The current camera settings (p.521) will be registered under the Mode Dial's C\* position.

## **Automatic Update of Registered Settings**

If you change a setting while you shoot in the <**C1**>, <**C2**>, or <**C3**> mode, the respective Custom shooting mode can be automatically updated to reflect the changes (Auto update). To enable this automatic update, set [**Auto update set.**] to [**Enable**] in step 2.

## **Canceling Registered Custom Shooting Modes**

If you select [**Clear settings**] in step 2, the settings of respective modes can be reverted to the default settings with no Custom shooting modes registered.



 HDR movie shooting and My Menu settings will not be registered under Custom shooting modes.







-  ● Even in the <**C1**>, <**C2**>, and <**C3**> modes, you can still change shooting function settings and menu settings.
- By pressing the <**INFO.**> button, you can check which shooting mode is registered under <**C1**>, <**C2**>, and <**C3**> (p.87).

## Settings To Be Registered

### ● Shooting functions

Shooting mode, Shutter speed, Aperture, ISO speed, AF operation, AF area selection mode, AF point, Drive mode, Metering mode, Exposure compensation amount, AEB increment, Flash exposure compensation amount

### ● Menu display

- [ **1**] Image quality, Image review time, Beep, Release shutter without card, Lens aberration correction, Flash firing, E-TTL II flash metering, Flash sync speed in Av mode
- [ **2**] Exposure compensation/AEB, ISO speed settings, Auto Lighting Optimizer, White balance, Custom White Balance, White balance shift/bracketing, Color space
- [ **3**] Picture Style, Long exposure noise reduction, High ISO speed noise reduction, Highlight tone priority, Multiple exposure (settings), HDR Mode (settings)
- [ **4**] Interval timer, Bulb timer, Anti-flicker shooting, Mirror lockup
- [ **5 (Live View shooting)**] Live View shooting, AF method, Touch shutter, Grid display, Aspect ratio, Exposure simulation
- [ **6 (Live View shooting)**] Silent LV shooting, Metering timer

 **4 (Movie shooting)**

Movie Servo AF, AF method, Grid display, Movie recording quality (excluding 24.00p), Sound recording, AF speed with Movie Servo AF, Movie Servo AF tracking sensitivity

 **5 (Movie shooting)**

Metering timer, Movie recording count, Movie play count,  button function, Time-lapse movie (setting), Remote control shooting

**[AF1]** Case 1, Case 2, Case 3, Case 4, Case 5, Case 6

**[AF2]** AI Servo 1st image priority, AI Servo 2nd image priority

**[AF3]** Lens electronic MF, AF-assist beam firing, One-Shot AF release priority

**[AF4]** Lens drive when AF impossible, Selectable AF point, Select AF area selection mode, AF area selection method, Orientation linked AF point, Initial AF point with  AI Servo AF, Auto AF point selection: EOS iTR AF

**[AF5]** AF point selection movement, AF point display during focus, VF display illumination, AF status in viewfinder, AF microadjustment (excluding adjustment value)

**[▶2]** Image jump with 

**[▶3]** Highlight alert, AF point display, Playback grid, Histogram display, Movie play count, Magnification (approx.)

**[🔍1]** File numbering, Auto rotate, Eye-Fi settings

**[🔍2]** Auto power off, LCD brightness, LCD color tone, Viewfinder display, Touch control

**[🔍3]** Auto cleaning, **[INFO]** button display options, **[RATE]** button function

**[🔍5]** Multi function lock

**[🔍.1]** Exposure level increments, ISO speed setting increments, Bracketing auto cancel, Bracketing sequence, Number of bracketed shots, Safety shift, Same exposure for new aperture

**[🔍.2]** Set shutter speed range, Set aperture range

**[🔍.3]** Live View shooting area display, Dial direction during Tv/Av, Custom Controls

**[🔍.4]** Add cropping information, Default Erase option, Retract lens on power off, Add IPTC information

# 15

## Reference

This chapter provides reference information for system accessories, camera features, etc.



### Certification Logo

Select [**5: Certification Logo Display**] and press <ⓈET> to display some of the logos of the camera's certifications. Other certification logos can be found in this Instruction Manual, on the camera body, and on the camera's package.

# System Map

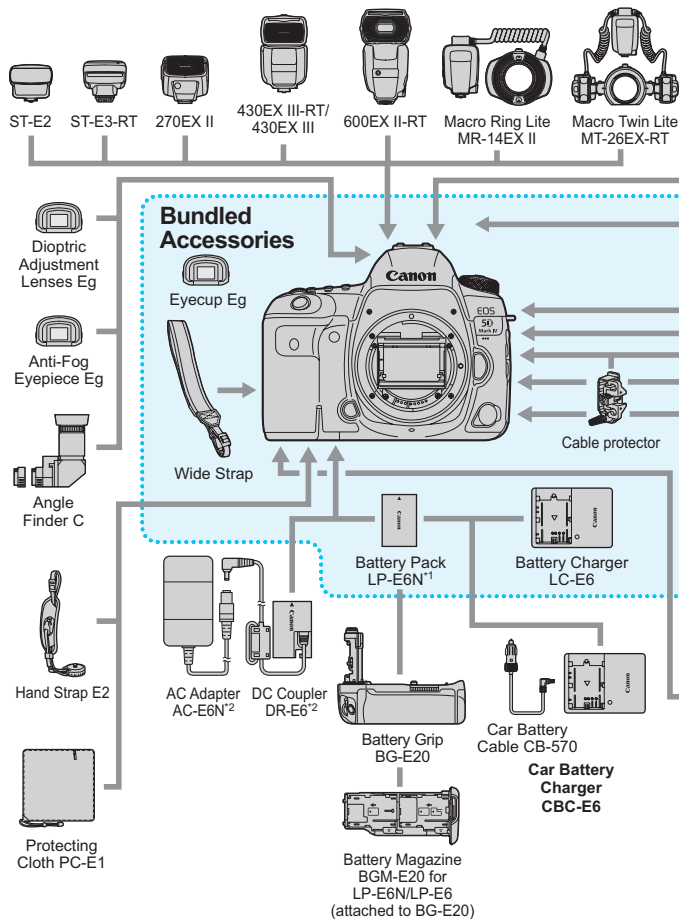

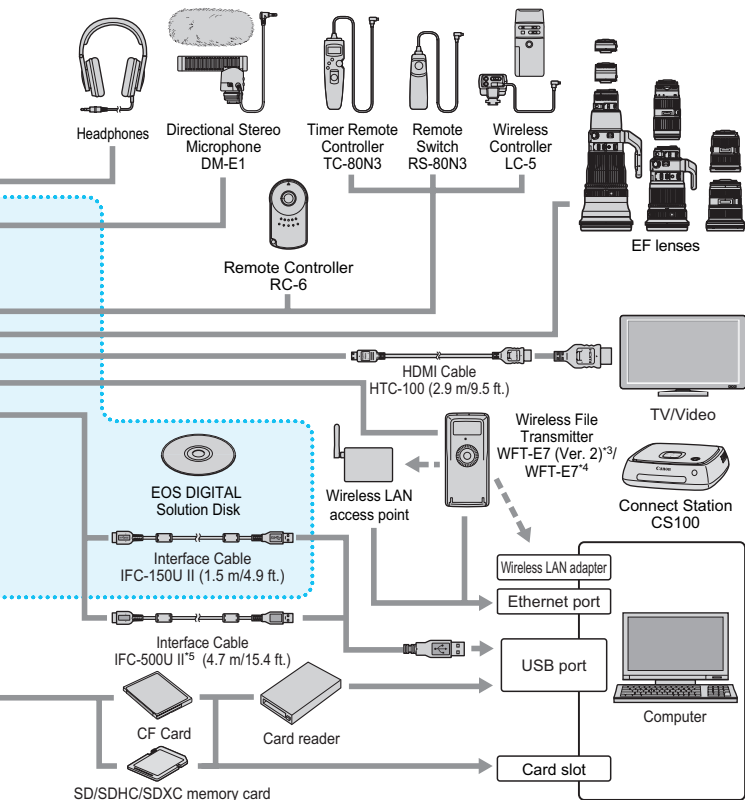

\*1: Battery Pack LP-E6 can also be used.

\*2: AC Adapter Kit ACK-E6 can also be used.

\*3: Check that the firmware of the WFT-E7 (Ver.2) is Version 1.3.0 or later.

\*4: To use the older model WFT-E7 (not Ver. 2), the WFT-E7's firmware must be updated and Interface Cable IFC-40AB II or IFC-150AB II must be used.

\*5: With IFC-500U II, the communication speed will be equivalent to Hi-Speed USB (USB 2.0).

\* All cable lengths given are approximate figures.

## MENU Checking the Battery Information

You can check the conditions of the battery you are using on the LCD monitor. Each Battery Pack LP-E6N/LP-E6 has a unique serial number, and you can register multiple battery packs to the camera. When you use this feature, you can check the registered batteries' approximate remaining capacity and usage history.

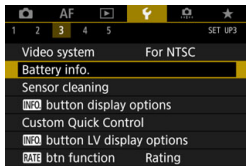

### Select [Battery info.].

- Under the [**3**] tab, select [**Battery info.**], then press <SET>.
- ▶ The battery info. screen will appear.

### Battery position

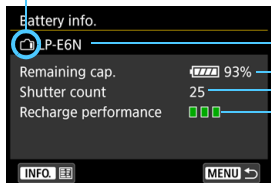

Battery model or household power source being used.

The battery level indicator (p.50) is displayed together with the remaining battery level shown in 1% increments.

The number of shots taken with the current battery. The number is reset when the battery is recharged.

Battery's recharge performance level is displayed in three levels.

■■■■ (Green): Battery's recharge performance is fine.

■■■■ (Green): Battery's recharge performance is slightly degraded.

■■■■ (Red): Purchasing a new battery is recommended.

**!** Using a genuine Canon Battery Pack LP-E6N/LP-E6 is recommended. If you use batteries that are not genuine Canon products, the camera's full performance may not be attained or malfunction may result.

- The shutter count is the number of still photos taken. (Movie shooting is not counted.)
- The battery information will also be displayed when using Battery Grip BG-E20 (sold separately).
- If a battery communication error message is displayed, follow the message.

## Registering Batteries to the Camera

You can register up to six LP-E6N/LP-E6 batteries to the camera. To register multiple batteries to the camera, follow the procedure below for each battery.

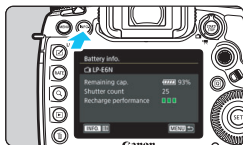

### 1 Press the <INFO.> button.

- With the battery info. screen displayed, press the <INFO.> button.
- ▶ The battery history screen will appear.
- ▶ If the battery is not registered, it will be grayed out.

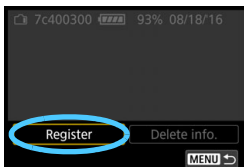

### 2 Select [Register].

- ▶ The confirmation dialog will appear.

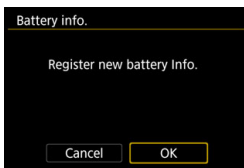

### 3 Select [OK].

- ▶ The battery will be registered and the battery history screen will reappear.
- ▶ The grayed out battery number will now be displayed in white.
- Press the <MENU> button. The battery info. screen will reappear.



- The battery cannot be registered if the household power outlet accessories (sold separately, p.530) are used.
- If six batteries are already registered, [Register] cannot be selected. To delete unnecessary battery information, see page 529.

## Labeling Serial Numbers on Batteries

It is convenient to label each registered Battery Pack LP-E6N/LP-E6 with their serial numbers, using commercially-available labels.

Serial number

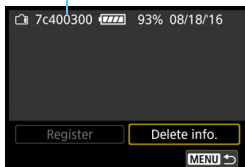

### 1 Write the serial number on a label.

- Write the serial number displayed on the battery history screen on a label approx. 25 mm x 15 mm / 1.0 in. x 0.6 in. in size.

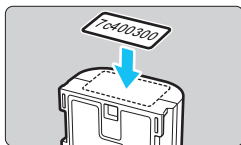

### 2 Remove the battery and affix the label.

- Set the power switch to **<OFF>**.
- Open the battery compartment cover and remove the battery.
- Affix the label as shown in the illustration (on the side with no electrical contacts).
- Repeat this procedure for all of your batteries so you can easily see the serial number.

- Do not affix the label on any part other than as shown in the illustration in step 2. Otherwise, the misplaced label may make it difficult to insert the battery or impossible to turn on the camera.
- If you use Battery Grip BG-E20 (sold separately), the label may peel off as you repeatedly insert and remove the battery into the battery magazine. If it peels off, affix a new label.



## Checking the Remaining Capacity of a Registered Battery

You can check the remaining capacity of any battery (even when not installed) and also when it was last used.

Serial number    Date last used

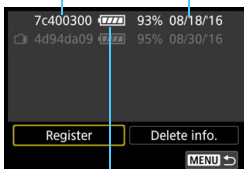

Battery level

### Look for the serial number.

- Refer to the battery's serial number label and look for the battery's serial number on the battery history screen.
- ▶ You can check the respective battery's remaining capacity and the date when it was last used.

## Deleting the Registered Battery Information

### 1 Select [Delete info.].

- Follow step 2 on page 527 to select [**Delete info.**], then press < (SET) >.

### 2 Select the battery information to be deleted.

- Select the battery information to be deleted, then press < (SET) >.
- ▶ [✓] will appear.
- To delete information for another battery, repeat this procedure.

### 3 Press the < [trash] > button.

- ▶ The confirmation dialog will appear.

### 4 Select [OK].

- ▶ The battery information will be deleted and the screen in step 1 will reappear.

## Using a Household Power Outlet

You can power the camera with a household power outlet by using the DC Coupler DR-E6 and AC Adapter AC-E6N (each sold separately).

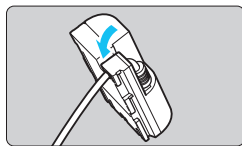

### 1 Place the cord in the groove.

- Carefully insert the DC coupler's cord into the groove without damaging the cord.

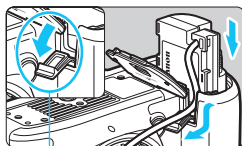

DC coupler cord hole

### 2 Insert the DC coupler.

- Open the battery compartment cover and open the DC coupler cord hole cover.
- Insert the DC coupler securely until it locks and put the cord through the hole.
- Close the cover.

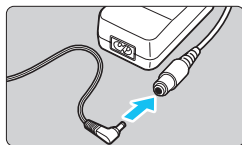

### 3 Connect the DC coupler to the AC adapter.

- Connect the DC coupler's plug to the AC adapter's connector securely.

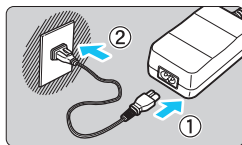

### 4 Connect the power cord.

- Connect the power cord to the AC adapter and insert the power plug into a power outlet.

### 5 Set the camera's power switch to <ON> (p.49).



- Do not use an AC adapter other than the AC-E6N (sold separately).
- While the camera's power switch is on, do not connect or disconnect the power cord or connector, or disconnect the DC coupler.
- After using the camera, unplug the power plug from the power outlet.



AC Adapter Kit ACK-E6 can also be used.

## Using Eye-Fi Cards

With a commercially-available Eye-Fi card already set up, you can automatically transfer captured images to a computer or upload them to an online service via a wireless LAN.



The image transfer is a function of the Eye-Fi card. For instructions on how to set up and use the Eye-Fi card or to troubleshoot any image transfer problems, refer to the Eye-Fi card's instruction manual or contact the card manufacturer.

 **The camera is not guaranteed to support Eye-Fi card functions (including wireless transfer). In case of a problem with an Eye-Fi card, please check with the card manufacturer. Also note that approval is required to use Eye-Fi cards in many countries or regions. Without approval, use of the card is not permitted. If it is unclear whether the card has been approved for use in your area, please check with the card manufacturer.**

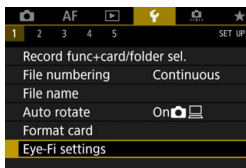
### 1 Insert an Eye-Fi card (p.45).



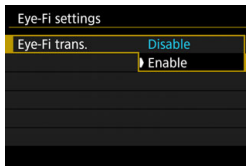

### 2 Select [Eye-Fi settings].

- Under the [ 1] tab, select [**Eye-Fi settings**], then press < >.
- This menu is displayed only when an Eye-Fi card is inserted into the camera.



### 3 Enable Eye-Fi transmission.

- Select [**Eye-Fi trans.**], then press < >.
- Select [**Enable**], then press < >.
- If you set [**Disable**], there will be no automatic transmission even with the Eye-Fi card inserted (transmission status icon ).

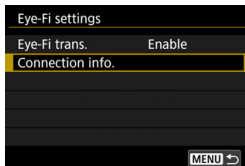

#### 4 Display the connection information.

- Select [**Connection info.**], then press <SET>.



#### 5 Check the [**Access point SSID:**].

- Check that an access point is displayed for [**Access point SSID:**].
- You can also check the Eye-Fi card's MAC address and firmware version.
- Press the <MENU> button to exit the menu.

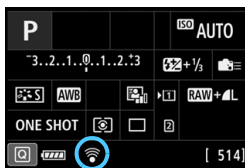



#### 6 Take the picture.

- ▶ The picture is transferred and the [Wi-Fi] icon switches from gray (not connected) to one of the icons in the sequence below.
- For transferred images, [Wi-Fi] is displayed in the shooting information display (p.398).

Transmission status

- 📶 (Gray) **Not connected** : No connection with access point.
- 📶 (Blinking) **Connecting...** : Connecting to access point.
- 📶 (Illuminated) **Connected** : Connection to access point established.
- 📶 (1) **Transferring...** : Image transfer to access point in progress.

## Cautions for Using Eye-Fi Cards

- If **[Wi-Fi/NFC]** under **[F4: Wireless communication settings] [Built-in wireless settings]** is set to **[Enable]**, image transfer with an Eye-Fi card will not be possible.
- If “” is displayed, an error occurred while retrieving the card information. Turn the camera's power switch off and on again.
- Even if **[Eye-Fi trans.]** is set to **[Disable]**, it may still transmit a signal. In hospitals, airports, and other places where wireless transmissions are prohibited, remove the Eye-Fi card from the camera beforehand.
- If the image transfer does not function, check the Eye-Fi card and computer settings. For details, refer to the card's instruction manual.
- Depending on the wireless LAN's connection conditions, the image transfer may take longer or it may be interrupted.
- Because of the communication function, the Eye-Fi card may become hot.
- The camera's battery power will be consumed faster.
- During the image transfer, auto power off will not take effect.
- If you insert a wireless LAN card other than an Eye-Fi card, **[F1: Eye-Fi settings]** will not appear. Also, the transmission status icon <> will not appear.



# Function Availability Table by Shooting Mode

## Still Photo Shooting

● : Set automatically ○ : User selectable □ : Not selectable/Disabled

Function			P	Tv	Av	M	B
All image quality settings selectable		○	○	○	○	○	○
Dual Pixel RAW		○	○	○	○	○	○
Aspect ratio*1			○	○	○	○	○
ISO speed	Automatically set/Auto	●	○	○	○	○	○
	Manually set		○	○	○	○	○
Picture Style	Automatically set/Auto	●	○	○	○	○	○
	Manual selection		○	○	○	○	○
White balance	Auto	●	○	○	○	○	○
	Preset		○	○	○	○	○
	Custom		○	○	○	○	○
	Color temperature setting		○	○	○	○	○
	Correction/Bracketing		○	○	○	○	○
Auto Lighting Optimizer		●	○	○	○	○	○
Long exposure noise reduction			○	○	○	○	○
High ISO speed noise reduction		●	○	○	○	○	○
Highlight tone priority			○	○	○	○	○
Lens aberration correction	Peripheral illumination correction	●	○	○	○	○	○
	Distortion correction		○	○	○	○	○
	Digital Lens Optimizer		○	○	○	○	○
	Chromatic aberration correction	●	○	○	○	○	○
	Diffraction correction	●	○	○	○	○	○
Anti-flicker shooting*2		●	○	○	○	○	○
Color space	sRGB	●	○	○	○	○	○
	Adobe RGB		○	○	○	○	○
AF	One-Shot AF	●*3	○	○	○	○	○
	AI Servo AF*2		○	○	○	○	○
	Servo AF*1		○	○	○	○	○
	AI Focus AF*2	●*4	○	○	○	○	○
	AF area selection mode*2		○	○	○	○	○
	AF point selection	●*4	○	○	○	○	○
	Manual focusing (MF)	○	○	○	○	○	○
	AF Microadjustment*2		○	○	○	○	○
	+Tracking*1	○	○	○	○	○	○
	FlexiZone - Multi*1	○	○	○	○	○	○
	FlexiZone - Single*1	○	○	○	○	○	○



Function			P	Tv	Av	M	B
Drive	Single shooting	○	○	○	○	○	○
	High-speed continuous shooting	○	○	○	○	○	○
	Low-speed continuous shooting	○	○	○	○	○	○
	Silent single shooting*2	○	○	○	○	○	○
	Silent continuous shooting*2	○	○	○	○	○	○
	10-sec. self-timer/Remote control	○	○	○	○	○	○
	2 sec. self-timer/Remote control	○	○	○	○	○	○
Metering	Evaluative metering	●	○	○	○	○	○
	Partial metering		○	○	○	○	○
	Spot metering		○	○	○	○	○
	Center-weighted average		○	○	○	○	○
Exposure	Program shift		○				
	Exposure compensation		○	○	○	○*5	
	AEB		○	○	○	○	
	AE lock		○	○	○	*6	
	Depth-of-field preview		○	○	○	○	○
	HDR shooting		○	○	○	○	
	Multiple exposures		○	○	○	○	○
	Interval timer*2	○	○	○	○	○	
	Bulb timer						○
	Mirror lockup*2		○	○	○	○	○
External Speedlite	Flash exposure compensation		○	○	○	○	○
	FE lock*2		○	○	○	○	○
	Flash function settings		○	○	○	○	○
	Custom Function settings		○	○	○	○	○
GPS function	○	○	○	○	○	○	
Live View shooting	○	○	○	○	○	○	
Quick Control	○	○	○	○	○	○	
Touch control	○	○	○	○	○	○	

\*1: Settable only with Live View shooting (enabled).

\*2: Settable only with viewfinder shooting (enabled).

\*3: Automatically set for Live View shooting.







\*4: Automatically set for viewfinder shooting.







\*5: Settable only with ISO Auto set.

\*6: With ISO Auto, you can set a fixed ISO speed.

## Movie Shooting

●: Set automatically ○: User selectable □: Not selectable/Disabled

Function			<b>P/B</b>	<b>Tv</b>	<b>Av</b>	<b>M</b>
						
<b>Select all movie recording qualities</b>		○	○	○	○	○
<b>HDR movie shooting</b>		○	○	○	○	○
<b>Time-lapse movie</b>		○	○	○	○	○
<b>ISO speed</b>	Automatically set/Auto	●	●	●	●	○
	Manually set	□	□	□	□	○
<b>Picture Style</b>	Automatically set/Auto	●	○	○	○	○
	Manual selection	□	○	○	○	○
<b>White balance</b>	Auto	●	○	○	○	○
	Preset	□	○	○	○	○
	Custom	□	○	○	○	○
	Color temperature setting	□	○	○	○	○
	Correction	□	○	○	○	○
<b>Auto Lighting Optimizer</b>		●	○	○	○	○
<b>High ISO speed noise reduction<sup>*1*2</sup></b>		●	○	○	○	○
<b>Highlight tone priority</b>		□	○	○	○	○
<b>Lens aberration correction</b>	Peripheral illumination correction	●	○	○	○	○
	Chromatic aberration correction	●	○	○	○	○
<b>AF</b>	⌂+Tracking	○	○	○	○	○
	FlexiZone - Multi	○	○	○	○	○
	FlexiZone - Single	○	○	○	○	○
	Manual focusing (MF)	○	○	○	○	○
	Movie Servo AF <sup>*3</sup>	○	○	○	○	○

Function			<b>P/B</b>	<b>Tv</b>	<b>Av</b>	<b>M</b>
						
<b>Metering</b>		●	●	●	●	●
<b>Exposure</b>	Program shift					
	Exposure compensation		○	○	○	○ <sup>*4</sup>
	AE lock		○	○	○	<sup>*5</sup>
<b>Sound recording</b> <sup>*3</sup>	Auto	●	○	○	○	○
	Custom		○	○	○	○
<b>Time code</b>		○	○	○	○	○
<b>HDMI output</b>		○	○	○	○	○
<b>GPS function</b>		○	○	○	○	○
<b>Quick Control</b>		○	○	○	○	○
<b>Touch control</b>		○	○	○	○	○

\*1: Cannot be set for 4K movie shooting.

\*2: Multi Shot Noise Reduction cannot be set.

\*3: Cannot be set for High Frame Rate movie shooting.

\*4: Settable only with ISO Auto set.

\*5: With ISO Auto, you can set a fixed ISO speed.

# Menu Settings

## Viewfinder Shooting and Live View Shooting

: Shooting 1 (Red)

Page









Image quality	RAW / M RAW / S RAW	169
	L,  L,  M,  M,  S1,  S1, S2, S3	
Dual Pixel RAW*	Disable / Enable	175
Image review time	Off / 2 sec. / 4 sec. / 8 sec. / Hold	77
Beep	Enable / Touch to  / Disable	76
Release shutter without card	Enable / Disable	46
Lens aberration correction	Peripheral illumination: Enable / Disable	207
	Distortion correction*: Disable / Enable	
	Digital Lens Optimizer*: Disable / Enable	
	Chromatic aberration: Enable / Disable	
	Diffraction correction*: Enable / Disable	
External Speedlite control	Flash firing / E-TTL II metering / Flash sync. speed in Av mode / Flash function settings / Flash C.Fn settings / Clear settings	289

\* Not displayed for movie shooting.

- 
- Shaded menu options are not displayed in the <[A+]> mode.
  - What is displayed under [ 1: Image quality] depends on the [Record func.] (p.166) setting under [ 1: Record func+card/folder sel.]. If [Rec. separately] is set, set the image quality for each card.
  - With movie shooting, certain menu items are not displayed. Also, the [ 6] tab will not appear.

 Shooting 2 (Red)

Page

<b>Exposure compensation/AEB setting</b> <sup>*1</sup>	1/3- and 1/2-stop increments, $\pm 5$ stops (AEB $\pm 3$ stops)	255 257
<b>ISO speed settings</b>	ISO speed / Range for stills / Auto range / Minimum shutter speed	177 180 181 182
<b>Auto Lighting Optimizer</b>	Disable / Low / Standard / High	201
	Disabled in M or B modes	
<b>White balance</b>	<b>AWB</b> (Ambience priority) / <b>AWB w</b> (White priority) /  /  /  /  /  /  /  /  (Approx. 2500 - 10000)	192
<b>Custom White Balance</b>	Manual setting of white balance	195
<b>White balance shift/bracketing</b> <sup>*2</sup>	White balance correction: B/A/M/G bias, 9 levels each	198
	White balance bracketing: B/A and M/G bias, single-level increments, $\pm 3$ levels	199
<b>Color space</b> <sup>*3</sup>	sRGB / Adobe RGB	217









\*1: During movie shooting, [**2: Expo.comp./AEB**] will be [**2: Exposure comp.**].

\*2: During movie shooting, [**2: WB Shift/Bkt.**] will be [**2: WB correction**].

\*3: Not displayed for movie shooting.

 **Shooting 3 (Red)**

Page

<b>Picture Style</b>	 Auto /  Standard /  Portrait /  Landscape /  Fine Detail /  Neutral /  Faithful /  Monochrome /  User Def. 1-3	183
<b>Noise reduction for long exposures<sup>*1</sup></b>	Disable / Auto / Enable	204
<b>High ISO speed noise reduction<sup>*2</sup></b>	Disable / Low / Standard / High / Multi Shot Noise Reduction <sup>*1</sup>	202
<b>Highlight tone priority</b>	Disable / Enable	206
<b>Dust Delete Data</b>	Obtain data to be used with Digital Photo Professional (EOS software) to delete dust spots	460
<b>Multiple exposure<sup>*1</sup></b>	Multiple exposure / Multiple exposure control / Number of exposures / Save source images / Continuous multiple exposure / Select image for multiple exposures	268
<b>HDR Mode<sup>*1</sup></b>	Adjust dynamic range / Effect / Continuous HDR / Auto Image Align / Save source images	263

\*1: Not displayed for movie shooting.

\*2: Cannot be set for 4K movie shooting.

**📷: Shooting 4\*<sup>1</sup> (Red)**

Page

Interval timer	Disable / Enable (Interval / Number of shots)	281
Bulb timer* <sup>2</sup>	Disable / Enable (Exposure time)	261
Anti-flicker shooting	Disable / Enable	215
Mirror lockup	Disable / Enable	276

\*1: In the <[A]<sup>+</sup>> mode, these menu options are displayed under [📷2].

\*2: Settable in the <B> mode.

**📷: Shooting 5\* (Red)**

Live View shooting	Enable / Disable	299
AF method	☑️+Tracking / FlexiZone - Multi / FlexiZone - Single	316
Touch shutter	Disable / Enable	327
Grid display	Off / 3x3 田 / 6x4 田田 / 3x3+diag 田田	309
Aspect ratio	3:2 / 4:3 / 16:9 / 1:1	310
Exposure simulation	Enable / During 📷 / Disable	311

\* In the <[A]<sup>+</sup>> mode, these menu options are displayed under [📷3].

**📷: Shooting 6 (Red)**

Silent LV shooting	Mode 1 / Mode 2 / Disable	312
Metering timer	4 sec. / 8 sec. / 16 sec. / 30 sec. / 1 min. / 10 min. / 30 min.	313

**AF: AF1 (Purple)**

Page

<b>Case 1</b>	Versatile multi purpose setting	128
<b>Case 2</b>	Continue to track subjects, ignoring possible obstacles	128
<b>Case 3</b>	Instantly focus on subjects suddenly entering AF points	129
<b>Case 4</b>	For subjects that accelerate or decelerate quickly	129
<b>Case 5</b>	For erratic subjects moving quickly in any direction	130
<b>Case 6</b>	For subjects that change speed and move erratically	131

**AF: AF2 (Purple)**

<b>AI Servo 1st image priority</b>	Release priority / Equal priority / Focus priority	136
<b>AI Servo 2nd image priority</b>	Shooting speed priority: -2/-1 / Equal priority: 0 / Focus priority: +1/+2	137









**AF: AF3 (Purple)**

<b>Lens electronic MF</b>	Enable after One-Shot AF / Disable after One-Shot AF / Disable in AF mode	138
<b>AF-assist beam firing</b>	Enable / Disable / IR AF assist beam only	139
<b>One-Shot AF release priority</b>	Release priority / Focus priority	140



## AF: AF4 (Purple)

Page

<b>Lens drive when AF impossible</b>	Continue focus search / Stop focus search	141
<b>Selectable AF point</b>	All points / Only cross-type AF points / 15 points / 9 points	142
<b>Select AF area selection mode</b>	Manual selection: Spot AF / Manual selection: 1 point AF / Expand AF area:  / Expand AF area: Surround / Manual selection: Zone AF / Manual selection: Large Zone AF / Auto selection AF	143
<b>AF area selection method</b>	 → M-Fn button /  → Main Dial	144
<b>Orientation linked AF point</b>	Same for both vertical/horizontal / Separate AF points: Area+point / Separate AF points: Point only	144
<b>Initial AF Point,  AI Servo AF</b>	Initial  AF point selected / Manual     AF point / Auto	146
<b>Auto AF point selection: EOS iTR AF</b>	EOS iTR AF (Face priority) / EOS iTR AF / Disable	147

## AF: AF5 (Purple)

<b>AF point selection movement</b>	Stops at AF area edges / Continuous	148
<b>AF point display during focus</b>	Selected (constant) / All (constant) / Selected (pre-AF, focused) / Selected (focused) / Disable display	149
<b>VF display illumination</b>	Auto / Enable / Disable	150
	AF point during AI Servo AF: Non illuminated / Illuminated	
<b>AF operation display in viewfinder</b>	Show in field of view / Show outside view	151
<b>AF Microadjustment</b>	Disable / All by same amount / Adjust by lens	151

## ▶: Playback 1 (Blue)

Page



<b>Protect images</b>	Protect images	412
<b>Rotate image</b>	Rotate images	411
<b>Erase images</b>	Erase images	440
<b>Print order</b>	Specify images to be printed (DPOF)	471
<b>Photobook set-up</b>	Specify images for a photobook	476
<b>Image copy</b>	Copy images between cards	435
<b>RAW image processing</b>	Process <b>RAW</b> images	446

## ▶: Playback 2 (Blue)

<b>Cropping</b>	Partially crop JPEG images	454
<b>Resize</b>	Downsize JPEG image's pixel count	452
<b>Rating</b>	[OFF] / [•] / [••] / [•••] / [••••] / [•••••]	416
<b>Slide show</b>	Set playback description / Display time / Repeat	429
<b>Image transfer</b>	Image selection/transfer / RAW+JPEG transfer / Transfer with caption	468
<b>Image jump w/ </b>	1 image / 10 images / 100 images / Date / Folder / Movies / Stills / Protect / Rating	404



## ▶: Playback 3 (Blue)

Page

<b>Highlight alert</b>	Disable / Enable	401
<b>AF point display</b>	Disable / Enable	402
<b>Playback grid</b>	Off / 3x3  / 6x4  / 3x3+diag 	396
<b>Histogram display</b>	Brightness / RGB	402
<b>Movie playback count*</b>	Recording time / Time code	366
<b>Magnification (Approx.)</b>	1x (no magnification) / 2x (magnify from center) / 4x (magnify from center) / 8x (magnify from center) / 10x (magnify from center) / Actual size (from selected point) / Same as last magnification (from center)	407
<b>Control over HDMI</b>	Disable / Enable	433

\* The setting is linked to the [Movie play count] for [Time code] under the [CAMERA] (Movie) tab.

## 🔑: Set-up 1 (Yellow)

<b>Record function+card/ folder selection</b>	Recording function: Standard / Auto switch card / Record separately / Record to multiple	166
	Record/playback / Playback: [1] / [2]	168
	Folder: Selecting and creating a folder	218
<b>File numbering</b>	Continuous / Auto reset / Manual reset	223
<b>File name</b>	Preset code / User setting 1 / User setting 2	220
<b>Auto rotate vertical images</b>	On   / On  / Off	444
<b>Format card</b>	Erase data on the card by formatting	73
<b>Eye-Fi settings</b>	Displayed when a commercially-available Eye-Fi card is inserted	532



 **Set-up 2 (Yellow)**

Page

<b>Auto power off</b>	1 min. / 2 min. / 4 min. / 8 min. / 15 min. / 30 min. / Disable	76
<b>LCD brightness</b>	Auto: Adjustable to one of three brightness levels	442
	Manual: Adjustable to one of seven brightness levels	
<b>LCD color tone</b>	1: Warm tone / 2: Standard / 3: Cool tone 1 / 4: Cool tone 2	443
<b>Date/Time/Zone</b>	Date (year, month, day) / Time (hr., min., sec.) / Daylight saving time / Time zone	51
<b>Language</b> 	Select the interface language	54
<b>Viewfinder Information</b>	Electronic level: Hide / Show	83
	Grid display: Hide / Show	81
	Show/hide in viewfinder: Battery / Shooting mode / White balance / Drive mode / AF operation / Metering mode / Image quality (Image type) / Digital Lens Optimizer / Dual Pixel RAW / Flicker detection	84
<b>Touch control</b>	Standard / Sensitive / Disable	72

### ☛: Set-up 3 (Yellow)

Page

<b>Video system</b>	For NTSC / For PAL	352 432
<b>Battery information</b>	Power source / Remaining capacity / Shutter count / Recharge performance	526
<b>Sensor cleaning</b>	Auto cleaning  : Enable / Disable	458
	Clean now 	
	Clean manually	463
<b>INFO button display options</b>	Displays camera settings / Electronic level / Quick Control screen / Custom Quick Control screen	86
<b>Custom Quick Control</b>	Start editing layout / Revert layout to default / Clear all items	510
<b>INFO button LV display options</b>	Live View info switch setting: 1 / 2 / 3 / 4	305
	Histogram display • Brightness/RGB: Brightness / RGB • Display size: Large / Small	306
	Reset	
<b>RATE button function</b>	Rating / Protect	415
		414

### ☛: Set-up 4 (Yellow)

<b>HDMI output frame rate</b> <sup>*1*2</sup>	Auto / 59.94i/50.00i / 59.94p/50.00p / 23.98p	390
<b>GPS setting</b>	GPS / Auto time setting / Position update interval / GPS information display / GPS Logger	227
<b>Wireless communication settings</b> <sup>*3</sup>	Built-in wireless settings: Wi-Fi/NFC / Wi-Fi function / Send images to smartphone / Nickname / Clear settings	-
	FTP transfer settings: Automatic transfer / Transfer type/size / Transfer with SET / Set root certification	

\*1: Not settable if [Movie rec quality]'s [24.00p] is set to [Enable] under [📷 4 (Movie)] tab.

\*2: Displayed contents vary depending on the [🔧 3: Video system] setting.

\*3: For details, refer to "Wi-Fi (Wireless Communication) Function Instruction Manual" (p.4).

📌 When using the GPS function, built-in Wi-Fi (wireless communication) function or Wireless File Transmitter WFT-E7 (Ver. 2 / sold separately), be sure to check the region of use and use the function in accordance with the laws and regulations of the country or region.

## 🔧: Set-up 5 (Yellow)

Page

<b>Multi function lock</b>	Main Dial / Quick Control Dial / Multi-controller / AF area selection button / Touch control	90
<b>Custom shooting modes (C1-C3)</b>	Register setting / Clear settings / Auto update settings	520
<b>Clear all camera settings</b>	Resets the camera to the default settings	77
<b>Copyright information</b>	Display copyright information / Enter author's name / Enter copyright details / Delete copyright information	225
<b>Certification Logo Display</b>	Displays some of the logos of the camera's certifications	523
<b>📷 firmware ver.</b>	Select to update the firmware of the camera, lens, Speedlite, or wireless file transmitter	–

📌 To prevent an inadvertent update in the firmware, selecting [🔧 5: 📷 firmware ver.] will disable touch control.

 : Custom Functions (Orange)

Page

<b>C.Fn1: Exposure</b>	Customize camera functions as desired	482
<b>C.Fn2: Exposure</b>		488
<b>C.Fn3: Display/ Operation</b>		489
<b>C.Fn4: Others</b>		491
<b>C.Fn5: Clear</b>		Clear all Custom Function settings

 : My Menu (Green)

<b>Add My Menu tab</b>	Add My Menu tabs 1-5	515
<b>Delete all My Menu tabs</b>	Delete all My Menu tabs	518
<b>Delete all items</b>	Delete all items under My Menu tabs 1-5	518
<b>Menu display</b>	Normal display / Display from My Menu tab / Display only My Menu tab	519

## Movie Shooting

### 📷: Shooting 2 (Movie) (Red)

Page

<b>ISO speed settings</b>	ISO speed / Range for movies / Range for 4K	379
---------------------------	---------------------------------------------	-----

### 📷: Shooting 4\*1 (Movie) (Red)

<b>Movie Servo AF</b>	Enable / Disable	380
<b>AF method</b>	+Tracking / FlexiZone - Multi / FlexiZone - Single	382
<b>Grid display</b>	Off / 3x3 田 / 6x4 田田 / 3x3+diag 田田	382
<b>Movie recording quality</b>	MOV / MP4	351
	Movie recording size*2 • 4K (4096x2160) / Full HD (1920x1080) • NTSC: 59.94p / 29.97p / 23.98p • PAL: 50.00p / 25.00p • MJPG (Motion JPEG) / ALL-I (For editing) / IPB (Standard) / IPB (Light)	352
	24.00p: Disable / Enable	357
	High Frame Rate: Disable / Enable*3	358
<b>Sound recording</b>	Sound recording: Auto / Manual / Disable	362
	Recording level	
	Wind filter: Disable / Enable	363
	Attenuator: Disable / Enable	



<b>Movie Servo AF Speed</b> <sup>*4</sup>	When active: Always on / During shooting	383
	AF speed: Slow (-7/-6/-5/-4/-3/-2/-1) / Standard / Fast (+1/+2)	
<b>Movie Servo AF track sensitivity</b> <sup>*4</sup>	Locked on (-3/-2/-1) / 0 / Responsive (+1/+2/+3)	384

\*1: In the <[A+] > mode, these menu options are displayed under [CAM 2].

\*2: The movie recording size will vary depending on the [MOV/MP4], [24.00p], and [High Frame Rate] settings and the [F3: Video system] setting.

\*3: High Frame Rate movies will be shot in HD quality.

\*4: Not settable if [CAM 4: AF method] is set to [L+Tracking] or [FlexiZone - Multi].

### 📷: Shooting 5<sup>\*1</sup> (Movie) (Red)

<b>Metering timer</b>	4 sec. / 8 sec. / 16 sec. / 30 sec. / 1 min. / 10 min. / 30 min.	385
<b>Time code</b>	Count up / Start time setting / Movie recording count / Movie play count <sup>*2</sup> / HDMI / Drop frame <sup>*3</sup>	365
<b>👁️ button function</b>	Ⓜ️AF/- / Ⓜ️/- / Ⓜ️AF/📺 / Ⓜ️/📺	386
<b>Time-lapse movie</b>	Disable / Enable (Interval / No. of shots / Time required / Playback time / Card- time left)	371
<b>HDMI display</b>	📺 / 📺 without information / 📺+📺	387
<b>Remote control shooting</b>	Disable / Enable	389

\*1: In the <[A+] > mode, these menu options are displayed under [CAM 3].

\*2: Setting is linked to [CAM 3: Movie play count].

\*3: Displayed when **119.9P** (119.9fps), **59.94P** (59.94fps), or **29.97P** (29.97fps) is set.

# Troubleshooting Guide

If a problem occurs with the camera, first consult this Troubleshooting Guide. If this Troubleshooting Guide does not resolve the problem, contact your dealer or nearest Canon Service Center.

## Power-Related Problems

### The battery does not recharge.

- If the battery's remaining capacity is 94% or higher, the battery will not be recharged (p.526).
- Do not use any battery other than genuine Canon Battery Pack LP-E6N/LP-E6.

### The charger's lamp blinks at high speed.

- If (1) the battery charger or battery has a problem or (2) communication with the battery failed (with a non-Canon battery pack), the protection circuit will stop charging, and the charge lamp will blink in orange at a high speed. In the case of (1), unplug the charger's power plug from the power outlet. Detach and reattach the battery to the charger. Wait a few minutes, then reconnect the power plug to the power outlet. If the problem persists, contact your dealer or nearest Canon Service Center.

### The charger's lamp does not blink.

- If the internal temperature of the battery attached to the charger is high, the charger will not charge the battery for safety reasons (lamp off). During charging, if the battery's temperature becomes high for any reason, charging will stop automatically (lamp blinks). When the battery temperature goes down, charging will resume automatically.

### The camera is not activated even when the power switch is set to <ON>.

- Make sure the battery compartment cover is closed (p.44).
- Make sure the battery is installed properly in the camera (p.44).
- Recharge the battery (p.42).
- Make sure the card slot cover is closed (p.45).

### The access lamp still lights or blinks even when the power switch is <OFF>.

- If the power is turned off while an image is being recorded to the card, the access lamp will remain on or continue to blink for a few seconds. When the image recording is completed, the power will turn off automatically.

### [Does this battery/do these batteries display the Canon logo?] is displayed.

- Do not use any battery other than genuine Canon Battery Pack LP-E6N/LP-E6.
- Remove and install the battery again (p.44).
- If the electrical contacts are dirty, use a soft cloth to clean them.

### The battery becomes exhausted quickly.

- Use a fully-charged battery (p.42).
- The battery performance may have degraded. See [**43: Battery info.**] to check the battery's recharge performance level (p.526). If the battery performance is poor, replace the battery with a new one.
- The number of possible shots will decrease with any of the following operations:
  - Pressing the shutter button halfway for a prolonged period.
  - Activating the AF frequently without taking a picture.
  - Using the lens's Image Stabilizer.
  - Using GPS.
  - Using the LCD monitor frequently.
  - Continuing Live View shooting or movie shooting for a prolonged period.
  - Using the Wi-Fi/NFC (wireless communication) function frequently.
  - The Eye-Fi card's transmission is enabled.

### The camera turns off by itself.

- Auto power off is in effect. If you do not want auto power off to take effect, set [**⚡2: Auto power off**] to [**Disable**] (p.76).
- Even if [**⚡2: Auto power off**] is set to [**Disable**], the LCD monitor will still turn off after the camera is left idle for approx. 30 min. (The camera's power does not turn off.)

## Shooting-Related Problems

### The lens cannot be attached.

- The camera cannot be used with EF-S or EF-M lenses (p.55).

### The viewfinder is dark.

- Install a recharged battery in the camera (p.42).

### No images can be shot or recorded.

- Make sure the card is properly inserted (p.45).
- If you are using an SD card, slide the card's write-protect switch to the Write/Erase setting (p.45).
- If the card is full, replace the card or delete unnecessary images to make space (p.45, 439).
- If you try to focus in the One-Shot AF mode and the focus indicator <●> in the viewfinder blinks, or when the AF point is orange during Live View/movie shooting, a picture cannot be taken. Press the shutter button halfway again to refocus automatically, or focus manually (p.58, 159).

**The card cannot be used.**

- If a card error message is displayed, see page 48 or 573.

**An error message is displayed when the card is inserted in another camera.**

- CF cards with a capacity greater than 128 GB and SDXC cards are formatted in exFAT. This means that if you format a card with this camera and then insert it into another camera, an error may be displayed and it may not be possible to use the card.

**I have to press the shutter button twice completely to take a picture.**

- Set [ 4: Mirror lockup] to [Disable].

**The image is out of focus or blurred.**

- Set the lens's focus mode switch to <AF> (p.55).
- Press the shutter button gently to prevent camera shake (p.57, 58).
- If the lens has an Image Stabilizer, set the IS switch to <ON>.
- In low light, the shutter speed may become slow. Use a faster shutter speed (p.246), set a higher ISO speed (p.177), use flash (p.286), or use a tripod.
- See "Minimizing Blurred Photos" on page 96.

### **There are fewer AF points or the Area AF frame shape is different.**

- Depending on the attached lens, the number of usable AF points and patterns and Area AF frame's shape vary. The lenses are categorized into 11 groups from A to K (p.115). Check which group your lens belongs to. Using a lens in groups G to K will have fewer usable AF points (p.118-121).

### **The AF point is blinking or two AF points are displayed.**

- Regarding the AF points lighting up or blinking when you press the  button, see page 108.
- The registered AF point at that position is blinking (p.108, 500).
- The manually-selected AF point (or zone) and the registered AF point are displayed (p.107, 500).

### **I cannot lock the focus and recompose the shot.**

- Set the AF operation to One-Shot AF (p.100, 101, 314). Focus lock (p.97, 101) is not possible with AI Servo AF/Servo AF (p.102, 315) and when servo AF is used with AI Focus AF (p.102).

### **The AF points do not light up in red.**

- The AF points light up in red only when focus is achieved in low light or with a dark subject.
- In the **<P>**, **<Tv>**, **<Av>**, **<M>**, or **<B>** mode, you can set whether to have the AF points light in red for when focus is achieved (p.150).

### The continuous shooting speed is slow.

- The continuous shooting speed for high-speed continuous shooting may decrease depending on the power source type, battery level, temperature, flicker reduction, Dual Pixel RAW shooting, Digital Lens Optimizer, shutter speed, aperture, subject conditions, brightness, AF operation, lens, flash use, shooting function settings, etc. For details, see pages 160-162.

### The maximum burst during continuous shooting is lower.

- If you shoot something that has fine detail such as a field of grass, the file size will be larger, and the actual maximum burst may be lower than the number listed on page 171.
- If **[Rec. separately]** is set and different image-recording quality are set for the CF card (Card1) and SD card (Card2), the maximum burst for continuous shooting will decrease.
- Under **[📷1: Lens aberration correction]**, if **[Digital Lens Optimizer]** is set to **[Enable]**, the maximum burst for continuous shooting will greatly decrease.
- If **[📷1: Dual Pixel RAW]** is set to **[Enable]** and the image-recording quality is **RAW**, the maximum burst for continuous shooting will decrease.

### Even after I change the card, the maximum burst displayed for continuous shooting does not change.

- The maximum burst displayed in the viewfinder does not change when you change the card, even if it is a high-speed card. The maximum burst shown in the table on page 171 is based on Canon's testing card. (The faster the card's writing speed, the higher the actual maximum burst will be.) Therefore, the maximum burst displayed in the viewfinder may differ from the actual maximum burst.

### Dual Pixel RAW shooting is not possible.

- Set [**📷1: Dual Pixel RAW**] to [**Enable**], and set [**📷1: Image quality**] to **RAW** or **RAW+JPEG**.

### ISO 100 cannot be set. ISO speed expansion cannot be selected.

- If [**📷3: Highlight tone priority**] is set to [**Enable**], the settable ISO speed range will be ISO 200 - ISO 32000. Even if you set [**Range for stills**] to expand the setting range, you cannot select L (equivalent to ISO 50), H1 (equivalent to ISO 51200), or H2 (equivalent to ISO 102400). When [**📷3: Highlight tone priority**] is set to [**Disable**] (p.206), you can set ISO 100/125/160, L, or H1/H2.

### Even if I set a decreased exposure compensation, the image comes out bright.

- Set [**📷2: Auto Lighting Optimizer**] to [**Disable**] (p.201). When [**Low**], [**Standard**], or [**High**] is set, even if you set a decreased exposure compensation or flash exposure compensation, the image may come out bright.

### I cannot set the exposure compensation when both manual exposure and ISO Auto are set.

- See page 252 to set the exposure compensation.
- For flash shooting, exposure compensation will not take effect.

### Not all the lens aberration correction options are displayed.

- If [**Digital Lens Optimizer**] under [**📷1: Lens aberration correction**] is set to [**Enable**], [**Chromatic aberr corr**] and [**Diffraction correction**] will not be displayed. However, the [**Enable**] setting for both [**Chromatic aberr corr**] and [**Diffraction correction**] will take effect for shooting.
- During movie shooting, [**Distortion correction**], [**Digital Lens Optimizer**] or [**Diffraction correction**] will not be displayed.



### The shot image is not displayed during multiple-exposure shooting.

- If [**On:ContShtng**] is set, image review immediately after image capture or image playback is not possible during shooting (p.268).

### The multiple-exposure image is shot in **RAW** quality.

- When the image-recording quality is set to **M RAW** or **S RAW**, the multiple-exposure image will be recorded in **RAW** quality (p.275).

### When I use the **<Av>** mode with flash, the shutter speed becomes slow.

- If you shoot at night when the background is dark, the shutter speed automatically becomes slow (slow-sync shooting) so that both the subject and background are properly exposed. To prevent a slow shutter speed, under [**1: External Speedlite control**], set [**Flash sync. speed in Av mode**] to [**1/200-1/60sec. auto**] or [**1/200 sec. (fixed)**] (p.290).

### The flash does not fire.

- Make sure the flash (or PC sync cord) is securely attached to the camera.
- If you use a non-Canon flash unit with Live View shooting, set [**6: Silent LV shoot.**] to [**Disable**] (p.312).

### The flash always fires at full output.

- If you use a flash unit other than an EX-series Speedlite, the flash will always be fired at full output (p.287).
- When the flash Custom Function setting for [**Flash metering mode**] is set to [**TTL flash metering**] (autoflash), the flash will always be fired at full output (p.294).

### Flash exposure compensation cannot be set.

- If flash exposure compensation is already set with the Speedlite, flash exposure compensation cannot be set with the camera. When the external Speedlite's flash exposure compensation is canceled (set to 0), flash exposure compensation can be set with the camera.



### High-speed sync cannot be set in the <Av> mode.

- Under [ 1: External Speedlite control], set [Flash sync. speed in Av mode] to [Auto] (p.290).

### The shutter makes two release sounds during Live View shooting.

- If you use flash, the shutter will make two release sounds each time you shoot (p.300).

### During Live View shooting, a white < > or red < > icon is displayed.

- It indicates that the camera's internal temperature is high. If the white < > icon is displayed, the still photo's image quality may deteriorate. If the red < > icon is displayed, it indicates that the Live View shooting will soon stop automatically (p.331).

### Shot images are not displayed when continuous shooting is performed during Live View shooting.

- If the image-recording quality is set to **M RAW** or **S RAW**, the shot images are not displayed during continuous shooting (p.299).

### During movie shooting, the red icon is displayed.

- It indicates that the camera's internal temperature is high. If the red  icon is displayed, it indicates that the movie shooting will soon stop automatically (p.391).



### Movie shooting stops by itself.

- If the card's writing speed is slow, movie shooting may stop automatically. For cards that can record movies, see page 356. To find out the card's writing speed, refer to the card manufacturer's Web site.
- If you shoot a movie for 29 min. 59 sec. or shoot a High Frame Rate movie for 7 min. 29 sec., the movie shooting will stop automatically.

### The ISO speed cannot be set for movie shooting.

- If the shooting mode is  $\langle \text{A}^+ \rangle$ ,  $\langle \text{P} \rangle$ ,  $\langle \text{Tv} \rangle$ ,  $\langle \text{Av} \rangle$ , or  $\langle \text{B} \rangle$ , the ISO speed will be set automatically. In the  $\langle \text{M} \rangle$  mode, you can freely set the ISO speed (p.341).

### ISO 100 cannot be set or ISO speed expansion cannot be selected during movie shooting.

- If [3: Highlight tone priority] is set to [Enable], the settable ISO speed range will start from ISO 200. Even if you set [Range for movies] or [Range for ] for ISO speed expansion, you cannot select H, H1, or H2. When [3: Highlight tone priority] is set to [Disable] (p.206), you can set ISO 100/125/160, or an expanded ISO speed.
- During HDR movie shooting, expanded ISO speeds cannot be selected.

### The manually set ISO speed changes when switching to movie shooting.

- For viewfinder shooting and Live View shooting, the ISO speed will be set according to the setting of **[Range for stills]** under **[CAMERA 2: ISO speed settings]** (p.180). For movie shooting, the ISO speed will be set according to the setting of **[Range for movies]** or **[Range for 4K]** under **[CAMERA 2: ISO speed settings]** (p.379).

### The exposure changes during movie shooting.

- If you change the shutter speed or aperture during movie shooting, the changes in the exposure may be recorded.
- Shooting a few test movies is recommended if you intend to perform zooming during movie shooting. Zooming during movie shooting may result in recording of changes in exposure or mechanical sound of the lens, or images may be out of focus.

### The image flickers or horizontal stripes appear during movie shooting.

- Flickering, horizontal stripes (noise), or irregular exposures can be caused by fluorescent lighting, LED lighting, or other light sources during movie shooting. Also, changes in the exposure (brightness) or color tone may be recorded. In the **<Tv>** or **<M>** mode, a slow shutter speed may reduce the problem. The problem may be more noticeable in time-lapse movie shooting.

**The subject looks distorted during movie shooting.**

- If you move the camera to the left or right (panning) or shoot a moving subject, the image may look distorted. The problem may be more noticeable in time-lapse movie shooting.

**The movie does not record the sound.**

- High Frame Rate movies do not record sound.

**The time code is not appended.**

- For High Frame Rate movie shooting, if **[Free run]** is set for **[Count up]** under **[CAM 5: Time code]** (p.365), the time code will not be appended. Also, if there is HDMI output, the time code will not be appended to the HDMI video output (p.367).

**The time code's count is faster.**

- For High Frame Rate movie shooting, it will count up by 4 sec. for every sec. in real time (p.358).

**I cannot take still photos during movie shooting.**

- Still photos cannot be taken during movie shooting. To take still photos, stop the movie shooting and take still photos using viewfinder shooting or Live View shooting.

## Operation Problems

I cannot change the setting with the <☀> dial, <🕒> dial, <🌀>, <📷>, or <👉>.

- Set the <LOCK▶> switch to the left (lock release, p.62).
- Check the [👉5: Multi function lock] setting (p.90).

Touch operation is not possible.

- Check if [👉2: Touch control] is set to [Standard] or [Sensitive] (p.72).

A camera button or dial does not work as expected.

- Check the [👉3: Custom Controls] setting (p.495).

## Display Problems

The menu screen shows fewer tabs and options.

- In the <[A]<sup>+</sup>> mode, some menu tabs and options are not displayed. Set the shooting mode to <P>, <Tv>, <Av>, <M> or <B> (p.67).

The display starts with [★] My Menu or the [★] tab alone is displayed.

- Under the [★] tab, [Menu display] is set to [Display from My Menu tab] or [Display only My Menu tab]. Set [Normal display] (p.519).

**The file name's first character is an underscore (“\_”).**

- Set [📷2: Color space] to [sRGB]. If [Adobe RGB] is set, the first character will be an underscore (p.217).

**The fourth character in the file name changes.**

- [📷1: File name] is set to [\*\*\* + image size]. Select the camera's unique file name (preset code) or the file name registered under User setting 1 (p.220).

**The file numbering does not start from 0001.**

- If the card already contains recorded images, the image file number may not start from 0001 (p.223).

**The shooting date and time displayed are incorrect.**

- Make sure the correct date and time are set (p.51).
- Check the time zone and daylight saving time (p.52, 53).

**The date and time are not in the image.**

- The shooting date and time do not appear in the image. The date and time are recorded in the image data as shooting information. When printing, you can imprint the date and time in the picture, using the date and time recorded in the shooting information (p.471).

### **[###] is displayed.**

- If the number of images recorded on the card exceeds the number the camera can display, [###] will be displayed.

### **In the viewfinder, the AF point display speed is slow.**

- In low temperatures, the display speed of the AF points may become slower due to the AF point display device's (liquid crystal) characteristics. The display speed will return to normal at room temperature.

### **The LCD monitor does not display a clear image.**

- If the LCD monitor is dirty, use a soft cloth to clean it.
- The LCD monitor display may seem slightly slow in low temperatures or look black in high temperatures. It will return to normal at room temperature.

### **[Eye-Fi settings] does not appear.**

- [**🔒1: Eye-Fi settings**] will appear only when an Eye-Fi card is inserted in the camera. If the Eye-Fi card has a write-protect switch set to the LOCK position, you will not be able to check the card's connection status or disable Eye-Fi transmission (p.532).



## Playback Problems

### Part of the image blinks in black.

- [▶3: Highlight alert] is set to [Enable] (p.401).

### A red box is displayed on the image.

- [▶3: AF point disp.] is set to [Enable] (p.402).

### During image playback, the AF points are not displayed.

- When you play back an image applied with distortion correction (p.209), the AF points are not displayed.

### The image cannot be erased.

- If the image is protected, it cannot be erased (p.412).

### The movie cannot be copied.

- Copying movie files exceeding 4 GB may not work. For details, see page 435.

### Still photos and movies cannot be played back.

- The camera may not be able to play back images taken with another camera.
- Movies edited with a computer cannot be played back with the camera.

### Operation sound and mechanical sound can be heard during movie playback.

- If you operate the camera's dials or lens during movie shooting, the operation sound will also be recorded. Using the Directional Stereo Microphone DM-E1 (sold separately) is recommended (p.363).

### **The movie appears to freeze momentarily.**

- If there is a drastic change in the exposure level during autoexposure movie shooting, the recording will stop momentarily until the brightness stabilizes. In such a case, shoot in the <M> mode (p.340).

### **The movie plays in slow motion.**

- Since the High Frame Rate movie will be recorded as a 29.97 fps/25.00 fps movie file, it will play back in slow motion at 1/4 speed.

### **No picture on the TV set.**

- Make sure the [**3: Video system**] is correctly set to [**For NTSC**] or [**For PAL**] (depending on the video system of your TV set).
- Make sure the HDMI cable's plug is inserted all the way in (p.432).

### **There are multiple movie files for a single movie shoot.**

- If the movie file size reaches 4 GB, another movie file will be created automatically (p.360). However, if you use a CF card exceeding 128 GB or an SDXC card formatted with the camera, you can record a movie to a single file even exceeding 4 GB.

### **I cannot grab frames from a movie.**

- You can grab frames only from 4K movies. Frame grabbing is not possible with Full HD movies, High Frame Rate (HD) movies, and 4K movies shot with a different camera.

**My card reader does not recognize the card.**

- Depending on your card reader and computer OS, large-capacity CF cards or SDXC cards may not be properly recognized. In such a case, connect your camera to the computer with the interface cable, then transfer the images to the computer using EOS Utility (EOS software, p.598).

**I cannot process the RAW image.**

- **M RAW** and **S RAW** images cannot be processed with the camera. Use Digital Photo Professional (EOS software, p.598) to process those images.

**I cannot resize or crop the image.**

- With this camera, you cannot resize or crop JPEG **S3** images, **RAW/M RAW/S RAW** images, or frame-grab images from 4K movies saved as still photos (p.452, 454).

**Dots of light appear on the image.**

- White, red, blue, or other colored dots of light may appear on images if the sensor is affected by cosmic rays, etc. Their appearance may be suppressed if you perform [**Clean now** ↑□] under [**3: Sensor cleaning**] (p.458).

**The Dual Pixel information cannot be used for processing the RAW images.**

- Although Dual Pixel RAW images can be processed with [**1: RAW image processing**], this camera cannot process the image using Dual Pixel data. For using Dual Pixel data, process the images with the Digital Photo Professional (EOS software, p.598).

## Sensor Cleaning Problems

### The shutter makes a sound during sensor cleaning.

- When you select [**Clean now** ], the shutter will make a mechanical sound during the cleaning, but the picture will not be recorded to the card (p.458).

### Automatic sensor cleaning does not work.

- If you repeatedly turn the power switch <**ON**> and <**OFF**> within a short time period, the < > icon may not be displayed (p.49).

## Computer Connection Problems

### I cannot transfer images to a computer.

- From the EOS DIGITAL Solution Disk (CD-ROM, p.4), install EOS Utility (EOS software, p.598) to your computer (p.599).
- An interface cable cannot be used to connect the camera to a computer when a Wi-Fi connection is already established.
- When using [ **2: Image transfer**] to transfer images to a computer, make sure EOS Utility's main screen is displayed.

# Error Codes

Error number

If there is a problem with the camera, an error message will appear. Follow the on-screen instructions.

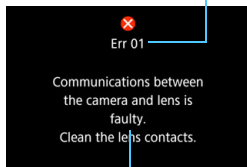

Cause and countermeasures

Number	Error Message and Solution
01	<b>Communications between the camera and lens is faulty. Clean the lens contacts.</b>
	→ Clean the electrical contacts on the camera and lens, use a Canon lens, or remove and install the battery again (p.27, 28, 44).
02	<b>Card* cannot be accessed. Reinsert or replace card * or format card * with the camera.</b>
	→ Remove and insert the card again, replace the card, or format the card (p.45, 73).
04	<b>Cannot save images because card* is full. Replace card*.</b>
	→ Replace the card, erase unnecessary images, or format the card (p.45, 439, 73).
06	<b>Sensor cleaning could not be performed. Turn the camera off and on again.</b>
	→ Operate the power switch (p.49).
10, 20 30, 40 50, 60 70, 80 99	<b>An error prevented shooting. Turn the camera off and on again or re-install the battery.</b>
	→ Operate the power switch, remove and install the battery again, or use a Canon lens (p.49, 44).

\* If the error still persists, write down the error code number and contact your nearest Canon Service Center.

# Specifications

## • Type

Type:	Digital, single-lens reflex, AF/AE camera
Recording media:	CF cards (Type I, UDMA Mode 7 supported) SD/SDHC*/SDXC* memory cards * UHS-I cards compatible.
Image sensor size:	Approx. 36.0 x 24.0 mm
Compatible lenses:	Canon EF lenses * Excluding EF-S and EF-M lenses (The effective angle of view of a lens is approximately equivalent to that of the focal length indicated.)
Lens mount:	Canon EF mount

## • Image Sensor

Type:	CMOS sensor
Effective pixels:	Approx. 30.4 megapixels * Rounded off to the nearest 10,000 pixels.
Aspect ratio:	3:2
Dust delete feature:	Auto/Manual, Appending Dust Delete Data

## • Recording System

Recording format:	Design rule for Camera File System (DCF) 2.0
Image type:	JPEG, RAW (14-bit Canon original), RAW+JPEG simultaneous recording possible
Pixels recorded:	L (Large) : Approx. 30.1 megapixels (6720 x 4480) M (Medium) : Approx. 13.3 megapixels (4464 x 2976) S1 (Small 1) : Approx. 7.5 megapixels (3360 x 2240) S2 (Small 2) : Approx. 2.5 megapixels (1920 x 1280) S3 (Small 3) : Approx. 0.35 megapixels (720 x 480) RAW : Approx. 30.1 megapixels (6720 x 4480) M-RAW : Approx. 16.9 megapixels (5040 x 3360) S-RAW : Approx. 7.5 megapixels (3360 x 2240)
Dual Pixel RAW:	Possible
Recording function:	Standard, Auto switch card, Record separately, Record to multiple
Create/select a folder:	Possible
File name:	Preset code / User setting 1 / User setting 2
File numbering:	Continuous, Auto reset, Manual reset

## • Image Processing During Shooting

Picture Style:	Auto, Standard, Portrait, Landscape, Fine Detail, Neutral, Faithful, Monochrome, User Defined 1 - 3
White balance:	Auto (Ambience priority), Auto (White priority), Preset (Daylight, Shade, Cloudy, Tungsten light, White fluorescent light, Flash), Custom, Color temperature setting (approx. 2500-10000 K) White balance correction and white balance bracketing features provided * Flash color temperature information transmission possible
Automatic image brightness correction:	Auto Lighting Optimizer provided
Noise reduction:	Applicable to high ISO speed shots and long exposures
Highlight tone priority:	Provided
Lens aberration correction:	Peripheral illumination correction, Distortion correction, Digital Lens Optimizer, Chromatic aberration correction, Diffraction correction

## • Viewfinder

Type:	Eye-level pentaprism
Coverage:	Vertical/Horizontal approx. 100% (with eyepoint approx. 21 mm)
Magnification:	Approx. 0.71x (-1 m <sup>-1</sup> with 50mm lens at infinity)
Eyepoint:	Approx. 21 mm (from eyepiece lens center at -1 m <sup>-1</sup> )
Dioptric adjustment range:	Approx. -3.0 - +1.0 m <sup>-1</sup> (dpt)
Focusing screen:	Fixed
Grid display:	Provided
Electronic level:	Provided
Function setting display:	Battery (remaining capacity), Shooting mode, White balance, Drive mode, AF operation, Metering mode, Image type: JPEG/RAW, Digital Lens Optimizer, Dual Pixel RAW, Flicker detection, Warning indicator, AF status
Mirror:	Quick-return type
Depth-of-field preview:	Provided

## • Autofocus (during viewfinder shooting)

Type:	TTL secondary image-registration, phase-difference detection with the dedicated AF sensor
AF points:	Max. 61 points (Cross-type AF point: Max. 41 points) * Number of available AF points, Dual cross-type AF points, and Cross-type AF points vary depending on the lens used. * f/2.8-sensitive, Dual cross-type AF at five center vertical AF points (AF group: With Group A lenses)
Focusing brightness range:	EV -3 - 18 (Conditions: f/2.8-sensitive center AF point, One-Shot AF, room temperature, ISO 100)
Focus operation:	One-Shot AF, AI Servo AF, AI Focus AF, Manual focusing (MF)
AF area selection mode:	Single-point Spot AF (manual selection), Single-point AF (manual selection), AF point expansion (manual selection: above, below, left, and right), AF point expansion (manual selection: surround), Zone AF (manual selection of zone), Large zone AF (manual selection of zone), Automatic selection AF
AF point automatic selection conditions:	Based on EOS iTR AF setting (Enables AF incorporating human face/color information) * iTR: Intelligent Tracking and Recognition
AF Configuration Tool:	Case 1 - 6
AI Servo AF characteristics:	Tracking sensitivity, Acceleration/deceleration tracking, AF point auto switching
AF function customization:	17 functions
AF fine adjustment:	AF Microadjustment (All lenses by the same amount, Adjust by lens)
AF-assist beam:	Emitted by the EOS-dedicated external Speedlite

## • Exposure Control

Metering mode:	Approx. 150,000-pixel RGB+IR metering sensor and 252-zone TTL open-aperture metering EOS iSA (Intelligent Subject Analysis) system • Evaluative metering (linked to all AF points) • Partial metering (approx. 6.1% of viewfinder at center) • Spot metering (approx. 1.3% of viewfinder at center) • Center-weighted average metering
Metering brightness range:	EV 0 - 20 (at room temperature, ISO 100)



Shooting mode:	Scene Intelligent Auto, Program AE, Shutter-priority AE, Aperture-priority AE, Manual exposure, Bulb exposure, Custom shooting modes (C1/C2/C3)
ISO speed (Recommended exposure index):	Scene Intelligent Auto: ISO 100 - ISO 12800 set automatically P, Tv, Av, M, B: ISO Auto, ISO 100 - ISO 32000 manual setting (in 1/3- or whole-stop increments), and expansion to L (equivalent to ISO 50), H1 (equivalent to ISO 51200), H2 (equivalent to ISO 102400) provided. * If highlight tone priority is set, the settable ISO speed range will be ISO 200 - ISO 32000.
ISO speed settings:	Still photo shooting range, Auto range, Auto minimum speed settable
Exposure compensation:	Manual: $\pm 5$ stops in 1/3- or 1/2-stop increments AEB: $\pm 3$ stops in 1/3- or 1/2-stop increments (can be combined with manual exposure compensation)
AE lock:	Auto: Applied in One-Shot AF mode with evaluative metering when focus is achieved Manual: With AE lock button
Flicker reduction:	Possible
Interval timer:	Shooting interval and shot count settable
Bulb timer:	Bulb exposure time settable

### • HDR Shooting

Dynamic range adjustment:	Auto, $\pm 1$ , $\pm 2$ , $\pm 3$
Effects:	Natural, Art standard, Art vivid, Art bold, Art embossed
Auto image align:	Provided

### • Multiple Exposures

Shooting method:	Function/control priority, Continuous shooting priority
Number of multiple exposures:	2 to 9 exposures
Multiple-exposure control:	Additive, Average, Bright, Dark

### • Shutter

Type:	Electronically-controlled, focal-plane shutter
Shutter speed:	1/8000 sec. to 30 sec. (total shutter speed range; available range varies by shooting mode), Bulb, X-sync at 1/200 sec.

## • Drive System

Drive mode:	Single shooting, High-speed continuous shooting, Low-speed continuous shooting, Silent single shooting, Silent continuous shooting, 10-sec. self-timer/remote control, 2-sec. self-timer/remote control
Continuous shooting speed:	High-speed continuous shooting: Max. approx. 7.0 shots/sec. * Continuous shooting speed decreases during Anti-flicker shooting, during Dual Pixel RAW shooting, during Live View shooting with Servo AF, or with Digital Lens Optimizer set. * The maximum continuous shooting speed during high-speed continuous shooting may decrease depending on the power source type, battery level, temperature, flicker reduction, Dual Pixel RAW shooting, Digital Lens Optimizer, shutter speed, aperture, subject conditions, brightness, AF operation, lens, flash use, shooting function settings, etc. Low-speed continuous shooting: Max. approx. 3.0 shots/sec. Silent continuous shooting: Max. approx. 3.0 shots/sec.
Max. burst:	JPEG Large/Fine: Approx. 110 shots (Card Full) RAW: Approx. 17 shots (Approx. 21 shots) RAW+JPEG Large/Fine: Approx. 13 shots (Approx. 16 shots) * Based on Canon's standard testing CF card (Standard: 8 GB / High speed: UDMA Mode 7, 64 GB) and Canon's testing standards (high-speed continuous shooting, ISO 100, Standard Picture Style, no IPTC information appended). * Figures in parentheses apply to an UDMA Mode 7, with a CF card based on Canon's testing standards. * "Card Full" indicates that shooting is possible until the card becomes full.

## • External Speedlite

Compatible Speedlites:	EX-series Speedlites
Flash metering:	E-TTL II autoflash
Flash exposure compensation:	±3 stops in 1/3- or 1/2-stop increments
FE lock:	Provided
PC terminal:	Provided
Flash control:	Flash function settings, Flash C.Fn settings

## • Live View Shooting

Focus method:	Dual pixel CMOS AF
AF method:	Face+Tracking, FlexiZone - Multi, FlexiZone - Single Manual focusing (approx. 5x and 10x magnification available for focus check)
Focusing brightness range:	EV -4 - 18 (at room temperature, ISO 100, One-Shot AF)
Metering mode:	Evaluative metering (315 zones), Partial metering (approx. 6.3% of Live View screen), Spot metering (approx. 2.7% of Live View screen), Center-weighted average metering
Metering brightness range:	EV 0 - 20 (at room temperature, ISO 100)
Exposure compensation:	±3 stops in 1/3- or 1/2-stop increments
Silent Live View shooting:	Provided (Mode 1 and 2)
Touch shutter:	Provided
Grid display:	3 types

## • Movie Shooting

Recording format:	MOV, MP4
Movie:	4K: Motion JPEG Full HD/HD: MPEG-4 AVC/H.264 variable (average) bit rate
Audio:	MOV: Linear PCM, MP4: AAC
Movie recording size:	4K (4096x2160), Full HD (1920x1080), HD (1280x720): High Frame Rate movie
Frame rate:	119.9p/59.94p/29.97p/24.00p/23.98p (with NTSC) 100.0p/50.00p/25.00p/24.00p (with PAL) * 119.9p/100.0p: High Frame Rate movie
Movie recording method/Compression rate:	Motion JPEG ALL-I (For editing/I-only), IPB (Standard), IPB (Light) * Motion JPEG and ALL-I available only when MOV is set. * IPB (Light) available only when MP4 is set.

## Specifications

Bit rate:	[MOV] 4K (29.97p/25.00p/24.00p/23.98p) : Approx. 500 Mbps Full HD (59.94p/50.00p)/ALL-I : Approx. 180 Mbps Full HD (59.94p/50.00p)/IPB : Approx. 60 Mbps Full HD (29.97p/25.00p/24.00p/23.98p)/ALL-I : Approx. 90 Mbps Full HD (29.97p/25.00p/24.00p/23.98p)/IPB (Standard) : Approx. 30 Mbps HD (119.9p/100.0p)/ALL-I : Approx. 160 Mbps [MP4] Full HD (59.94p/50.00p)/IPB (Standard) : Approx. 60 Mbps Full HD (29.97p/25.00p/24.00p/23.98p)/IPB (Standard) : Approx. 30 Mbps Full HD (29.97p/25.00p)/IPB (Light) : Approx. 12 Mbps
Card performance requirements (Writing/reading speed):	4K (29.97p/25.00p/24.00p/23.98p) : CF UDMA 7: 100 MB/sec. or faster : SD UHS-I 90 MB/sec. or faster Full HD (59.94p/50.00p)/ALL-I : CF UDMA 7: 60 MB/sec. or faster : SD UHS-I Speed Class 3 or faster Full HD (59.94p/50.00p)/IPB : CF 30 MB/sec. or faster : SD Speed Class 10 or faster Full HD (29.97p/25.00p/24.00p/23.98p)/ALL-I : CF 30 MB/sec. or faster : SD UHS-I Speed Class 3 or faster Full HD (29.97p/25.00p/24.00p/23.98p)/IPB (Standard) : CF 10 MB/sec. or faster : SD Speed Class 6 or faster Full HD (29.97p/25.00p)/IPB (Light) : CF 10 MB/sec. or faster : SD Speed Class 4 or faster HD (119.9p/100.0p) : CF UDMA 7: 60 MB/sec. or faster : SD UHS-I Speed Class 3 or faster
Focus method:	Dual pixel CMOS AF
AF method:	Face+Tracking, FlexiZone - Multi, FlexiZone - Single Manual focusing (approx. 5x and 10x magnification available for focus check)
Movie servo AF:	Possible * Movie Servo AF customizable

Focusing brightness range:	EV -4 - 18 (at room temperature, ISO 100, One-Shot AF)
Metering mode:	Center-weighted average and Evaluative metering with the image sensor * Automatically set by the focus method
Metering brightness range:	EV 0 - 20 (at room temperature, ISO 100, with center-weighted average metering)
Exposure control:	Autoexposure shooting (Program AE for movie shooting), Shutter-priority AE, Aperture-priority AE, Manual exposure
Exposure compensation:	±3 stops in 1/3- or 1/2-stop increments
ISO speed	[Full HD]
(Recommended exposure index):	Scene Intelligent Auto: Automatically set within ISO 100 - ISO 25600 P/Tv/Av/B: Automatically set within ISO 100 - ISO 25600, expandable to H (equivalent to ISO 32000), H1 (equivalent to ISO 51200), H2 (equivalent to ISO 102400) M: ISO Auto (automatically set within ISO 100 - ISO 25600), ISO 100 - ISO 25600 manual setting (in 1/3- or whole-stop increments), expandable to H (equivalent to ISO 32000), H1 (equivalent to ISO 51200), H2 (equivalent to ISO 102400) * The settable range is different for HDR movie shooting and time-lapse movie shooting.
	[4K]
	Scene Intelligent Auto: Automatically set within ISO 100 - ISO 12800 P/Tv/Av/B: Automatically set within ISO 100 - ISO 12800, expandable to H (equivalent to ISO 16000/20000/25600/32000), H1 (equivalent to ISO 51200), H2 (equivalent to ISO 102400) M: ISO Auto (automatically set within ISO 100 - ISO 12800), ISO 100 - ISO 12800 manual setting (in 1/3- or whole-stop increments), expandable to H (equivalent to ISO 16000/20000/25600/32000), H1 (equivalent to ISO 51200), H2 (equivalent to ISO 102400)
ISO speed settings:	Range for movie shooting and 4K settable
Time code:	Appendable
Drop frames:	Compatible with 119.9p/59.94p/29.97p
Sound recording:	Built-in monaural microphone, external stereo microphone terminal provided Sound-recording level adjustable, wind filter provided, attenuator provided

## Specifications

Headphones:	Headphone terminal provided, sound volume adjustable
Grid display:	3 types
HDR movie shooting:	Provided
Time-lapse movie:	Shooting interval and shot count settable Required shooting time period, playback length, and remaining card capacity can be checked
2-screen display:	LCD monitor and HDMI output movie displayable simultaneously
HDMI output:	Image without information can be output. * Auto / 59.94i/50.00i / 59.94p/50.00p / 23.98p selectable. * When [24.00p: Enable] is set, the movie image is output at 24.00p via HDMI. * Time code appendable
Remote control shooting:	Provided
Accessory mount:	Bottom equipped with positioning hole to prevent rotation.
Still photo shooting:	Not possible during movie shooting.

### • LCD Monitor

Type:	TFT color, liquid-crystal monitor
Monitor size and dots:	Wide 8.1 cm (3.2-in) (3:2) with approx. 1.62 million dots
Brightness adjustment:	Auto (Dark, Standard, Bright), Manual (7 levels)
Color tone adjustment:	Warm tone / Standard / Cool tone 1 / Cool tone 2
Electronic level:	Provided
Interface languages:	25
Touch screen:	Capacitive sensing
Help display:	Possible

### • Playback

Image display format:	Single-image display (without shooting information), Single-image display (with basic information), Single-image display (Shooting information displayed: Detailed information, Lens/histogram, White balance, Picture Style 1, Picture Style 2, Color space/noise reduction, Lens aberration correction 1, Lens aberration correction 2, GPS information, IPTC information), Index display (4/9/36/100 images), Two-image display
-----------------------	------------------------------------------------------------------------------------------------------------------------------------------------------------------------------------------------------------------------------------------------------------------------------------------------------------------------------------------------------------------------------------------------------------------------------------

Highlight alert:	Overexposed highlights blink
AF point display:	Provided (may not be displayed depending on shooting conditions)
Grid display:	3 types
Magnified view:	Approx. 1.5x-10x, initial magnification and position settable
Image browsing method:	Single image, Jump by 10 or 100 images, By shooting date, By folder, By movies, By stills, By protected images, By rating
Image rotation:	Provided
Image protection:	Provided
Rating:	Provided
Movie playback:	Enabled (LCD monitor, HDMI)
Start/end movie scene editing:	Possible
4K Frame Grab:	Frame Grab can be saved as JPEG image.
Slide show:	All images, By date, By folder, By movies, By stills, By protected images, By rating
Copying images:	Possible

### • Post-Processing of Images

In-camera RAW image processing:	Brightness adjustment, White balance, Picture Style, Auto Lighting Optimizer, High ISO speed noise reduction, JPEG image-recording quality, Color space, Lens aberration correction (Peripheral illumination correction, Distortion correction, Digital lens optimizer, Chromatic aberration correction, Diffraction correction)
Resize:	Provided
Cropping:	Provided

### • Image Transfer

Transferrable files:	Still photos (JPEG, RAW, RAW+JPEG images), Movies
----------------------	---------------------------------------------------

### • Print Ordering

DPOF:	Version 1.1 compliant
-------	-----------------------

## • GPS Functions

Compatible satellites:	GPS satellites (USA), GLONASS satellites (Russia), Quasi-Zenith Satellite System (QZSS) MICHIBIKI (Japan)
GPS signal reception modes:	Mode 1, Mode 2
Geotag information appended to image:	Latitude, Longitude, Elevation, Coordinated Universal Time (UTC), Satellite signal acquisition status
Position update interval:	1 sec., 5 sec., 10 sec., 15 sec., 30 sec., 1 min., 2 min., 5 min.
Time setting:	GPS time data set to camera
Log data:	One file per day, NMEA format * Change in time zone creates another file. * The log data saved in internal memory can be transferred to a card or downloaded to a computer as a log file.
Log data deletion:	Possible

## • Customization Features

Custom Functions:	17 functions
Custom Quick Control:	Provided
Custom shooting modes:	Register under C1, C2, or C3 mode
My Menu:	Up to 5 screens can be registered
Copyright information:	Text entry and appending possible
IPTC information:	Appendable

## • Interface

DIGITAL terminal:	SuperSpeed USB (USB 3.0) Computer communication, Wireless File Transmitter WFT-E7 (Ver. 2), Connect Station CS100 connection
HDMI mini OUT terminal:	Type C (Auto switching of resolution), CEC-compatible
External microphone IN terminal:	3.5 mm diameter stereo mini-jack Directional Stereo Microphone DM-E1 connection
Headphone terminal:	3.5 mm diameter stereo mini-jack
Remote control terminal:	For N3-type remote control units
Wireless remote control:	Compatible with Remote Controller RC-6
Eye-Fi card:	Supported



## • Power

Battery:	Battery Pack LP-E6N/LP-E6, quantity 1 * AC power usable with household power outlet accessories.
Battery information:	Power source, Battery level, Shutter count, Recharge performance, Battery registration indicated
Number of possible shots:	With viewfinder shooting: Approx. 900 shots at room temperature (23°C/73°F), approx. 850 shots at low temperatures (0°C/32°F) With Live View shooting: Approx. 300 shots at room temperature (23°C/73°F), approx. 280 shots at low temperatures (0°C/32°F) * With a fully-charged Battery Pack LP-E6N.
Movie shooting time:	Total approx. 1 hr. 30 min. at room temperature (23°C/73°F) Total approx. 1 hr. 20 min. at low temperatures (0°C/32°F) * With a fully-charged Battery Pack LP-E6N, Movie Servo AF disabled, and Full HD 29.97p/25.00p/24.00p/23.98p IPB (Standard).

## • Dimensions and Weight

Dimensions (W x H x D):	Approx. 150.7 x 116.4 x 75.9 mm / 5.93 x 4.58 x 2.99 in.
Weight:	Approx. 890 g / 31.39 oz. (Including battery, CF card, SD memory card), Approx. 800 g / 28.22 oz. (Body only)

## • Operation Environment

Working temperature range:	0°C - 40°C / 32°F - 104°F
Working humidity:	85% or less

## Specifications

---

- All the data above is based on Canon's testing standards and CIPA (Camera & Imaging Products Association) testing standards and guidelines.
- Dimensions and weight listed above are based on CIPA Guidelines (except weight for camera body only).
- Product specifications and the exterior are subject to change without notice.
- If a problem occurs with a non-Canon lens attached to the camera, consult the respective lens manufacturer.

## Trademarks

- Adobe is a trademark of Adobe Systems Incorporated.
- Microsoft and Windows are trademarks or registered trademarks of Microsoft Corporation in the United States and/or other countries.
- Macintosh and Mac OS are trademarks of Apple Inc., registered in the U.S. and other countries.
- CompactFlash is a trademark of SanDisk Corporation.
- SDXC logo is a trademark of SD-3C, LLC.
- HDMI, HDMI logo, and High-Definition Multimedia Interface are trademarks or registered trademarks of HDMI Licensing LLC.
- Google™, Google Maps™, and Google Earth™ are trademarks of Google Inc.
- Map Utility uses Google Maps™ to display images and routes traveled on a map.
- All other trademarks are the property of their respective owners.

## About MPEG-4 Licensing

“This product is licensed under AT&T patents for the MPEG-4 standard and may be used for encoding MPEG-4 compliant video and/or decoding MPEG-4 compliant video that was encoded only (1) for a personal and non-commercial purpose or (2) by a video provider licensed under the AT&T patents to provide MPEG-4 compliant video. No license is granted or implied for any other use for MPEG-4 standard.”

\* Notice displayed in English as required.

### **Third party software**

This product includes third party software.

- expat.h

Copyright (c) 1998, 1999, 2000 Thai Open Source Software Center Ltd

Permission is hereby granted, free of charge, to any person obtaining a copy of this software and associated documentation files (the "Software"), to deal in the Software without restriction, including without limitation the rights to use, copy, modify, merge, publish, distribute, sublicense, and/or sell copies of the Software, and to permit persons to whom the Software is furnished to do so, subject to the following conditions:

The above copyright notice and this permission notice shall be included in all copies or substantial portions of the Software.

THE SOFTWARE IS PROVIDED "AS IS", WITHOUT WARRANTY OF ANY KIND, EXPRESS OR IMPLIED, INCLUDING BUT NOT LIMITED TO THE WARRANTIES OF MERCHANTABILITY, FITNESS FOR A PARTICULAR PURPOSE AND NONINFRINGEMENT. IN NO EVENT SHALL THE AUTHORS OR COPYRIGHT HOLDERS BE LIABLE FOR ANY CLAIM, DAMAGES OR OTHER LIABILITY, WHETHER IN AN ACTION OF CONTRACT, TORT OR OTHERWISE, ARISING FROM, OUT OF OR IN CONNECTION WITH THE SOFTWARE OR THE USE OR OTHER DEALINGS IN THE SOFTWARE.

## Use of Genuine Canon Accessories Is Recommended

This product is designed to achieve optimum performance when used with genuine Canon accessories. Therefore, using this product with genuine accessories is highly recommended.

Canon shall not be liable for any damage to this product and/or accidents such as malfunction, fire, etc., caused by the failure of non-genuine Canon accessories (e.g., a leakage and/or explosion of a battery pack). Please note that repairs arising out of the malfunction of non-genuine accessories will not be covered by the warranty for repairs, although you may request such repairs on a chargeable basis.



Battery Pack LP-E6N/LP-E6 is dedicated to Canon products only. Using it with an incompatible battery charger or product may result in malfunction or accidents for which Canon cannot be held liable.

## Digital Camera Model DS126601 Systems

This device complies with Part 15 of the FCC Rules. Operation is subject to the following two conditions: (1) This device may not cause harmful interference, and (2) this device must accept any interference received, including interference that may cause undesired operation.

**Note:** This equipment has been tested and found to comply with the limits for class B digital devices, pursuant to Part 15 of the FCC Rules. These limits are designed to provide reasonable protection against harmful interference in a residential installation. This equipment generates, uses and can radiate radio frequency energy and, if not installed and used in accordance with the instructions, may cause harmful interference to radio communications. However, there is no guarantee that interference will not occur in a particular installation. If this equipment does cause harmful interference to radio or television reception, which can be determined by turning the equipment off and on, the user is encouraged to try to correct the interference by one or more of the following measures:

- Reorient or relocate the receiving antenna.
- Increase the separation between the equipment and receiver.
- Connect the equipment into an outlet on a circuit different from that to which the receiver is connected.
- Consult the dealer or an experienced radio/TV technician for help.

The cable with the ferrite core provided with the digital camera must be used with this equipment in order to comply with Class B limits in Subpart B of Part 15 of the FCC rules.

Do not make any changes or modifications to the equipment unless otherwise specified in the manual. If such changes or modifications should be made, you could be required to stop operation of the equipment.

Canon U.S.A. Inc.  
One Canon Park, Melville, NY 11747, U.S.A.  
Tel No. 1-800-OK-CANON (1-800-652-2666)

CAN ICES-3 (B) / NMB-3 (B)



USA and Canada only:

The Lithium ion/polymer battery that powers the product is recyclable. Please call 1-800-8-BATTERY for information on how to recycle this battery.

For CA, USA only

Included lithium battery contains Perchlorate Material – special handling may apply. See [www.dtsc.ca.gov/hazardouswaste/perchlorate/](http://www.dtsc.ca.gov/hazardouswaste/perchlorate/) for details.

### **CAUTION**

RISK OF EXPLOSION IF BATTERY IS REPLACED BY AN INCORRECT TYPE.  
DISPOSE OF USED BATTERIES ACCORDING TO LOCAL REGULATION.





# **MEMO**

---

---

---

---

---

---

---

---

---

---

---

---

---

---

---

---

---

---

---

---

---

---

---

---

---

---

# MEMO

---

---

---

---

---

---

---

---

---

---

---

---

---

---

---

---

---

---

---

---

---

---

---

---

---

# 16

## Downloading Images to a Computer / Software

This chapter explains how to transfer images from the camera to a computer, gives an overview of the software on the EOS DIGITAL Solution Disk (CD-ROM), and explains how to install the software on a computer. It also explains how to view the PDF files on the Software Instruction Manual CD-ROM.



**EOS DIGITAL Solution Disk**  
(Software)



**Software Instruction Manual**

# Downloading Images to a Computer

You can use EOS software to download the images in the camera to a computer. There are two ways to do this.

## Downloading by Connecting the Camera to the Computer

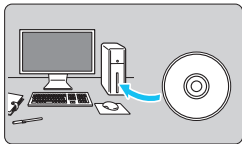

### 1 Install the software (p.599).

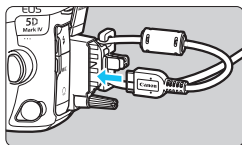

### 2 Use the provided interface cable to connect the camera to the computer.

- Use the interface cable provided with the camera.
- When connecting the cable to the camera, use the cable protector (p.38). Connect the cable to the digital terminal with the plug's <img alt="SS icon" data-bbox="455 575 485 595"/>> icon facing the back of the camera.
- Connect the cord's plug to the computer's USB terminal.

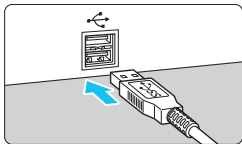

### 3 Use EOS Utility to transfer the images.

- For details, refer to the EOS Utility Instruction Manual (p.600).

 Use the provided interface cable or one from Canon (p.525). When connecting the interface cable, use the provided cable protector (p.38).

## Downloading Images with a Card Reader

You can use a card reader to download images to a computer.

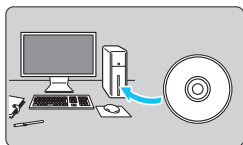

**1** Install the software (p.599).

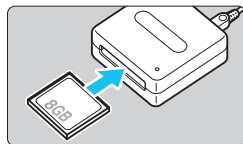

**2** Insert the card into the card reader.

**3** Use Digital Photo Professional to download the images.

- For details, refer to the Digital Photo Professional Instruction Manual (p.600).



When downloading images from the camera to a computer with a card reader without using EOS software, copy the DCIM folder on the card to the computer.

# Software Overview



## **EOS DIGITAL Solution Disk**

Various software for EOS DIGITAL cameras is contained on the EOS DIGITAL Solution Disk.

(Software Instruction Manuals are not contained on the EOS DIGITAL Solution Disk. See page 600.)

## **EOS Utility**

With the camera connected to a computer, EOS Utility enables you to transfer still photos and movies shot with the camera to the computer. You can also use this software to set various camera settings and shoot remotely from the computer connected to the camera.

## **Digital Photo Professional**

This software is recommended for users who shoot RAW images. You can view, edit, and print RAW and JPEG images.

\* Certain functions differ between the version to be installed on a 64-bit computer and that to be installed on a 32-bit computer.

## **Picture Style Editor**

You can edit Picture Styles, and create and save original Picture Style files. This software is aimed at advanced users who are experienced in image processing.

## ● Downloading from the Canon Web site

You can download the following software and Software Instruction Manuals from the Canon Web site.

[www.canon.com/icpd](http://www.canon.com/icpd)

### Map Utility

Shooting locations can be displayed on a map on a computer screen by using the geotag location information recorded. Note that Internet connection is required to use Map Utility.

### EOS MOVIE Utility

This software enables you to play back the movies you shot, consecutively play back movie files that were split up, and merge the split movie files and save it as a single file. You can also grab movie frames and save them as still photos.

## Installing the Software



- **Do not connect the camera to a computer before you install the software. The software will not be installed correctly.**
- If there is a previous version of the software already installed on the computer, follow the procedure below to install the latest version. (The previous version will be overwritten.)

- 1 Insert the EOS DIGITAL Solution Disk into the computer.**
  - For Macintosh, double-click to open the CD-ROM icon displayed on the desktop, then double-click on **[setup]**.
- 2 Click [Easy Installation] and follow the on-screen instructions to install.**
- 3 After the software is installed, remove the CD-ROM.**

# Software Instruction Manual



This disk contains the Software Instruction Manuals. You can copy and view the Software Instruction Manual (PDF files) as shown below.

You can also download the Software Instruction Manuals (PDF files) from the Canon Web site.

[www.canon.com/icpd](http://www.canon.com/icpd)

**1** Insert the [Software INSTRUCTION MANUAL] CD-ROM into the computer.

**2** Double-click the CD-ROM icon.

**3** Copy the [English] folder to the computer.

- Instruction Manuals (PDF files) with the names below are copied.

	Windows	Macintosh
EOS Utility	EUx.xW_E_xx	EUx.xM_E_xx
Digital Photo Professional	DPPx.xW_E_xx	DPPx.xM_E_xx
Picture Style Editor	PSEx.xW_E_xx	PSEx.xM_E_xx



**4** Double-click the copied PDF file.

- To read the Software Instruction Manuals (PDF files) on the computer, PDF viewing software such as Adobe Acrobat Reader DC must be installed (latest version recommended).
- Adobe Acrobat Reader DC can be downloaded for free from the Internet.
- To learn how to use PDF viewing software, refer to the software's Help section.



# Index

## Numerics

10- or 2-sec. self-timer .....	163
 1280x720 (movie) .....	352
 1920x1080 (movie).....	352
4, 9, 36, or 100 images .....	403
 4096x2160 (movie).....	352
4K frame capture .....	427

## A

 (Scene Intelligent Auto).....	94
AC adapter.....	530
Acceleration/deceleration tracking .....	133
Access lamp.....	47, 48
Accessories.....	3
Adjust all by same amount (AF)....	152
Adobe RGB.....	217
AE lock.....	259
AEB (Auto Exposure Bracketing) .....	257, 483
AF .....	99
AF area selection mode.....	104, 106, 109
AF-assist beam.....	139
AF Configuration Tool .....	127
AF function customization .....	136
AF groups .....	115
AF method.....	316, 382
AF Microadjustment.....	152
AF operation.....	100, 314
AF operation indicator .....	103
AF point auto switching .....	134
AF point red illumination... ..	103, 150
AF point registration .....	500

AF point selection .....	107, 503
AF sensor.....	113
Area AF frame.....	105, 111
Beeper .....	76
Color information.....	147
Cross-type focusing .....	113
Difficult subjects for AF ....	158, 324
Direct AF point selection .....	503
Dual cross-type focusing.....	113
f/8 AF .....	113, 114
Face information .....	147
Manual focusing (MF) .....	159, 329
Number of AF points .....	115
Out of focus.....	57, 58, 557
Recomposing.....	97, 101, 259
Spot AF point .....	31, 109
AF point expansion Manual Selection .....	104, 109
Manual selection, surrounding points .....	105, 110
AF-ON (AF start) button .....	58, 496, 498
AI FOCUS (AI Focus AF) .....	102
AI SERVO (AI Servo AF).....	97, 102
Acceleration/deceleration tracking .....	133
AF point auto switching.....	134
AF points light up in red ...	103, 150
Initial position .....	146
Tracking sensitivity.....	132
ALL-I (For editing/I-only).....	355
Ambience priority (AWB) .....	194
Ambient light sensor.....	29, 442
Anti-flicker shooting .....	215

Aperture-priority AE ..... 248, 336  
 Area AF frame ..... 105, 111  
 Aspect ratio ..... 310  
 Attenuator ..... 363  
 Auto (  ) ..... 184  
 Auto Lighting Optimizer ..... 93, 201  
 Auto playback ..... 429  
 Auto power off ..... 49, 76  
 Auto reset ..... 224  
 Auto switch card ..... 167  
 Auto time setting (GPS) ..... 237  
 Autofocus → AF  
 Automatic selection (AF) ..... 105, 111  
 Av (Aperture-priority AE) ..... 248, 336

## B



B/W ..... 185, 189  
 Basic information display ..... 397  
 Battery → Power  
 Battery Grip ..... 526  
 Beep (Beeper) ..... 76  
 Bit rate ..... 580  
 Black-and-white images ..... 185, 189  
 Bracketing  
   AEB (Auto exposure  
   bracketing) ..... 257, 483  
   FEB  
   (Flash exposure bracketing) ..... 293  
   WB-BKT (White balance  
   bracketing) ..... 199, 483  
 Built-in microphone ..... 334  
 B (Bulb exposures) ..... 260, 334  
 Bulb exposures  
   Bulb timer ..... 261

buSY (BUSY) ..... 174, 205

## C



 (Custom shooting) ..... 520  
 Cable protector ..... 38  
 Camera  
   Camera shake ..... 57, 96  
   Camera vibration blur ..... 96, 276  
   Clearing the camera settings to  
   default ..... 77  
   Holding the camera ..... 57  
   Settings display ..... 87  
 Cards ..... 5, 27, 45, 73, 356  
   Card reminder ..... 46  
   Card requirements ..... 356  
   Formatting ..... 73  
   Low-level formatting ..... 74  
   Troubleshooting ..... 48, 74  
   Write-protect switch ..... 45  
 Cases (AI Servo AF) ..... 127  
 Center-weighted average  
 metering ..... 254  
 CF card → Cards  
 Charger ..... 36, 42  
 Chromatic aberration correction ... 211  
 Cleaning (image sensor) ..... 457  
 Clearing the camera settings to  
 default ..... 77  
   AI Servo AF characteristics ..... 135  
   Camera function settings ..... 77  
   Custom Controls ..... 495  
   Custom Functions ..... 481  
   Custom Quick Control ..... 512  
   Flash function settings ..... 295

- My Menu ..... 518
- Clipped highlights ..... 401
- CLn ..... 463
- Color space ..... 217
- Color temperature ..... 192, 197
- Color tone ..... 188
- Continuous (file numbering) ..... 223
- Continuous shooting ..... 160
- Contrast ..... 188, 201
- Copying images ..... 435
- Copyright information ..... 225
- Creative photo ..... 183, 263, 268
- Cropping (images) ..... 454
- Cropping information ..... 491
- Cross-type focusing ..... 113
- Custom Controls ..... 495
- Custom Functions ..... 480, 482
- Custom Quick Control ..... 510
- Custom shooting modes ..... 520
- Custom White Balance ..... 195
- D**
- D+ ..... 206
- Date/time ..... 51
- Daylight saving time ..... 53
- DC Coupler ..... 530
- Default settings tables ..... 77
- Depth-of-field preview ..... 250
- Dials
- Main Dial ..... 59
- Quick Control Dial ..... 60
- Diffraction correction ..... 212
- Digital Lens Optimizer ..... 210, 450
- Digital terminal ..... 29, 38, 466, 596
- Dioptic adjustment ..... 57
- Direct selection (AF point) ..... 503
- Distortion correction ..... 209
- Downloading images to  
a computer ..... 596
- DPOF (Digital Print Order  
Format) ..... 471
- Dragging ..... 71
- Drive mode ..... 160
- Dual cross-type focusing ..... 113
- Dual Pixel RAW ..... 175
- Dust Delete Data ..... 460
- E**
- Electronic level ..... 82, 83
- Erasing images ..... 439
- Err (error codes) ..... 573
- Evaluative metering ..... 253
- exFAT ..... 74, 360
- Expanded ISO speed ... 177, 180, 379
- Exposure compensation ..... 255
- Exposure compensation in M mode  
with ISO Auto ..... 252
- Exposure level increments ..... 482
- Exposure level  
indicator ..... 32, 34, 301, 344
- Exposure maintained for new  
aperture ..... 486
- Exposure simulation ..... 311
- External microphone ..... 363
- External Speedlite → Flash
- Eyecup ..... 278
- Eye-Fi cards ..... 532
- Eyepiece cover ..... 37, 278

- F**
- Faithful (  ) ..... 185
  - FAT32 ..... 74, 360
  - FE lock ..... 286
  - Feature guide ..... 91
  - FEB (Flash Exposure Bracketing) ..... 293
  - File extension ..... 222
  - File name ..... 220
    - Underscore “\_” ..... 217, 222
  - File size ..... 171, 359, 398
  - Filter effect (Monochrome) ..... 189
  - Final image simulation ..... 304, 348
  - Fine (image-recording quality) ..... 169
  - Fine Detail (  ) ..... 184
  - Fineness (Sharpness) ..... 188
  - Firmware ..... 550
  - First-curtain synchronization ..... 293
  - Flash (Speedlite) ..... 285
    - Custom Functions ..... 294
    - External flash units ..... 286
    - FE lock ..... 286
    - Flash control (function settings) ..... 289
    - Flash exposure bracketing (FEB) ..... 293
    - Flash exposure compensation ..... 286, 293
    - Flash sync speed ..... 288, 290
    - Manual flash ..... 291
    - Shutter synchronization (1st/2nd curtain) ..... 293
    - Wireless ..... 292
  - Flash mode ..... 291
  - Flash sync contacts ..... 28
  - Flash sync. speed in Av mode ..... 290
  - Focus indicator ..... 94, 101
  - Focus lock ..... 97, 101
  - Focus mode switch ..... 6, 55, 159, 329
  - Focusing → AF
  - Focusing point (AF point) ..... 104, 107, 109, 113
  - Folder creation/selection ..... 218, 219
  - For editing (ALL-I) ..... 355
  - Formatting (card initialization) ..... 73
  - Frame Grab ..... 427
  - Frame rate ..... 352, 390
  - Free run ..... 365
  - Full Auto mode ..... 94
  - Full High-Definition (Full HD) (movie) ..... 333, 352
  - Functions available by shooting mode ..... 536
- G**
- GPS ..... 227
  - Grid ..... 81, 309, 382, 396
- H**
- H/H1/H2/H3 (expanded) ..... 177, 180, 379
  - HD (High Frame Rate movie) ..... 358
  - HDMI ..... 38, 420, 432
    - Connection indicator ..... 387
    - Output ..... 387, 390
    - Record command ..... 367
    - Time code ..... 367

- HDMI CEC ..... 433
  - HDR movie..... 369
  - HDR shooting..... 263
  - Headphones..... 363
  - Help..... 91
  - High-Definition ..... 352, 358
  - High Frame Rate..... 358
  - High ISO speed noise reduction ... 202
  - Highlight alert..... 401
  - Highlight tone priority ..... 206
  - High-speed continuous shooting... 160
  - Histogram..... 301, 344, 402
  - Hot shoe..... 28, 286
  - Household power ..... 530
- I**
- ICC profile ..... 217
  - Icons ..... 8
  - Illumination (AF point)..... 150
  - Illumination (LCD panel) ..... 63
  - Image dust prevention ..... 457
  - Image review time..... 77
  - Image-recording quality ..... 169, 351
    - Image size ..... 169, 352
  - Images
    - AF point display ..... 402
    - Auto playback ..... 429
    - Auto reset ..... 224
    - Auto rotation ..... 444
    - Continuous (file numbering) .... 223
    - Copying ..... 435
    - Downloading (to computer) ..... 596
    - Erasing ..... 439
    - File numbering..... 223
    - Highlight alert..... 401
    - Histogram..... 402
    - Index display ..... 403
    - Jump display
      - (image browsing) ..... 404
    - Magnified view ..... 406
    - Manual reset ..... 224
    - Manual rotation ..... 411
    - Playback ..... 393
    - Protecting images ..... 412
    - Rating..... 415
    - Shooting information ..... 398
    - Size ..... 171, 352, 398
    - Slide show..... 429
    - Transfer..... 466
    - Two-image display ..... 408
    - Viewing on a TV set..... 420, 432
  - Index display ..... 403
  - INFO.
    - button ..... 63, 86, 301, 305, 344, 394
  - Initial AF Point ..... 146
  - Initial magnification ratio/position . 407
  - Interval timer..... 281
  - IPB (Light) ..... 355
  - IPB (Standard)..... 355
  - IPTC information ..... 493
  - ISO speed ..... 177, 337, 341
    - Automatic setting (ISO Auto) ... 179
    - Automatic setting range ..... 181
    - ISO expansion ..... 180
    - Manual setting range ..... 180
    - Minimum shutter speed for
      - auto ..... 182
      - Range for movies..... 379

- Range for 4K ..... 379  
 Setting increments ..... 482  
 Range for stills ..... 180  
 iTR AF ..... 147
- J**
- JPEG ..... 169, 171  
 Jump display ..... 404
- L**
- Landscape (L) ..... 184  
 Language ..... 54  
 Large (image-recording quality) ..... 171  
 Large Zone AF ..... 105, 111  
 LCD monitor ..... 27  
 Brightness ..... 442  
 Color tone setting ..... 443  
 Electronic level ..... 82, 86  
 Image Playback ..... 393  
 Menu display ..... 67, 540  
 Quick Control ..... 64, 88  
 LCD Panel  
 Illumination ..... 63  
 Lens ..... 27, 55  
 AF group designations ..... 115  
 Chromatic aberration  
 correction ..... 211  
 Diffraction correction ..... 212  
 Digital Lens Optimizer ..... 210, 450  
 Distortion correction ..... 209  
 Focus mode  
 switch ..... 6, 55, 159, 329  
 Lock release ..... 56  
 Optical aberration correction ..... 207  
 Peripheral illumination  
 correction ..... 207  
 Light (IPB) ..... 355  
 Live View Shooting ..... 98, 297  
 AF operation ..... 314  
 Aspect ratio ..... 310  
 Exposure simulation ..... 311  
 Face+Tracking ..... 317  
 FlexiZone - Multi ..... 319  
 FlexiZone - Single ..... 321  
 Grid display ..... 309  
 Information display ..... 301  
 Manual focusing (MF) ..... 329  
 Metering timer ..... 313  
 Possible shots ..... 299  
 Quick Control ..... 308  
 Silent LV shooting ..... 312  
 LOCK ..... 62, 90  
 LOG ..... 238  
 Logging ..... 238  
 Log Data ..... 239  
 Long (bulb) exposures ..... 260  
 Long exposure noise reduction ..... 204  
 Low-speed continuous shooting... 161  
 LV → Live View Shooting
- M**
- M (Manual exposure) ..... 251, 340  
 Magnified view ..... 325, 329, 406  
 Main Dial ..... 59  
 Malfunction ..... 554  
 Manual exposure ..... 251, 340  
 Manual focusing (MF) ..... 159, 329  
 Manual reset ..... 224

- Manual selection
  - (AF point) ..... 104, 107, 109
  - Maximum burst ..... 171, 174
  - Medium
    - (image-recording quality) ..... 171
  - Memory cards → Cards
  - Menu ..... 67
    - Dimmed menu items ..... 69
    - My Menu ..... 515
    - Setting procedure ..... 68
    - Settings ..... 540
  - MENU** icon ..... 8
  - Metering mode ..... 253
  - Metering timer ..... 58, 313, 385
  - MF (Manual focusing) ..... 159, 329
  - M-Fn ..... 62, 106, 144, 497, 499
  - Microadjustment ..... 152
  - Microphone ..... 334, 363
    - Built-in ..... 334
    - External ..... 363
  - Mirror lockup ..... 276
  - Mode Dial ..... 35, 59
  - Monochrome () ..... 185
  - Motion JPEG () ..... 355
  - MOV ..... 351
  - Movies ..... 333
    - 24.00p ..... 357
    - AE lock ..... 338
    - AF method ..... 316, 382
    - AF speed during Movie
      - Servo AF ..... 383
    - Aperture-priority AE ..... 336
    - Attenuator ..... 363
    - Autoexposure shooting ..... 334
    - Compression method ..... 355
    - Drop frame ..... 368
    - Editing ..... 425
      - Editing out first and last scenes ..... 425
    - Enjoying movies ..... 420
    - External microphone ..... 363
    - File size ..... 359, 360
    - Frame Grab ..... 427
    - Frame rate ..... 352, 390
    - Free run ..... 365
    - Grid display ..... 382
    - HDMI output ..... 387, 390
    - HDR Movie Shooting ..... 369
    - Headphones ..... 363
    - High Frame Rate ..... 358
    - Information display ..... 344
    - Manual exposure shooting ..... 340
    - Metering timer ..... 385
    - Microphone ..... 334, 363
    - MOV/MP4 ..... 351
    - Movie recording method ..... 355
    - Movie Servo AF tracking
      - sensitivity ..... 384
    - Movie shooting button ..... 334, 386
    - One-Shot AF ..... 314
    - Playback ..... 420, 422
    - Playback count ..... 366
    - Quick Control ..... 350
    - Rec run ..... 365
    - Record command ..... 367
    - Recording quality (size) ..... 352
    - Recording time ..... 359
    - Recording/playback count ..... 366

Servo AF .....	380
Shutter speed .....	335, 340, 343
Shutter-priority AE .....	335
Sound recording/ Sound-recording level .....	362
Time code .....	365
Time-lapse movie .....	371
Viewing on a TV set .....	420, 432
Wind filter .....	363
MP4 .....	351
M-RAW (Medium RAW) .....	169, 171, 172, 173
Multi function... ..	62, 106, 144, 497, 499
Multi function lock .....	62, 90
Multi Shot Noise Reduction .....	202
Multi-controller .....	61
Multiple exposure.....	268
My Menu .....	515

## N

Neutral (  ) .....	184
Noise reduction	
High ISO speed .....	202
Long exposures .....	204
Nomenclature .....	28
Non-Canon flash units .....	288
Normal (Image-recording quality).....	169
NTSC .....	352, 432, 549

## O

ONE SHOT (One-Shot AF)... ..	101, 314
One-touch image quality setting .....	174, 507

Orientation linked AF point.....	144
----------------------------------	-----

## P

P (Program AE).....	244, 334
PAL.....	352, 432, 549
Partial metering .....	253
PC terminal .....	29, 288
Peripheral illumination correction .	207
Photobook set-up .....	476
Picture Style .....	183, 187, 190
Pixel count.....	169, 171
Playback.....	393
Portrait (  ).....	184
Positioning hole.....	30
Positioning interval (GPS) .....	236
Possible recording time (movie) .....	347, 359
Possible shots .....	50, 171, 299
Power .....	49
Auto power off.....	49, 76
Battery information.....	526
Battery level.....	50, 526
Charging .....	42
Household power .....	530
Possible shots.....	50, 171, 299
Recharge performance .....	526
Pressing completely .....	58
Pressing halfway .....	58
Printing	
Photobook set-up.....	476
Print order (DPOF).....	471
Program AE.....	244, 334
Program shift .....	245
Protecting images .....	412



**Q**

Q (Quick Control) ...64, 308, 350, 418  
 Quick Control Dial .....60

**R**

Rating mark .....415  
 RAW .....169, 171, 173  
 RAW image processing .....446  
 RAW+JPEG .....169, 171  
 Rec run .....365  
 Recharging .....42  
 Recording function .....166  
 Recording separately .....167  
 Recording to multiple cards .....167  
 Reduced display .....403  
 Release shutter without card .....46  
 Remote control terminal .....279  
 Remote switch .....279  
 Resizing .....452  
 Rotation (image) .....411, 444

**S**

Safety precautions .....22  
 Safety shift .....485  
 Saturation .....188  
 Scene icons .....303, 339  
 Scene Intelligent Auto .....94  
 ☆ icon .....8  
 SD, SDHC, SDXC cards → Cards  
 Second-curtain synchronization .....293  
 Self-timer .....163  
 Sensitivity → ISO speed  
 Sensor cleaning .....457  
 Sepia (Monochrome) .....189

Serial number .....30, 155, 526  
 Servo AF  
   AI Servo AF .....102  
   Movie Servo AF .....380, 383, 384  
   SERVO (LV) .....315  
 Sharpness .....188  
 Shooting information display .....398  
 Shooting modes .....35  
   Av (Aperture-priority AE) ..248, 336  
   B (Bulb) .....260, 334  
   C (Custom shooting) .....520  
   A+ (Scene Intelligent Auto) .....94  
   M (Manual exposure) .....251, 340  
   P (Program AE) .....244, 334  
   Tv (Shutter-priority AE) ...246, 335  
 Shutter button .....58  
 Shutter synchronization .....293  
 Shutter-priority AE .....246, 335  
 Silent shooting  
   Silent continuous shooting .....161  
   Silent LV shooting .....312  
   Silent single shooting .....161  
 Single shooting .....160, 161  
 Single-image display .....394  
 Single-point AF .....104, 109, 321  
 Single-point Spot AF .....104, 109  
 Slide show .....429  
 Small (image-recording quality) ...171  
 Software  
   Instruction Manual .....600  
 Sound recording/Sound-recording  
   level .....362  
 Speaker .....29, 422  
 Specifications .....574

Spot AF point ..... 31, 109  
 Spot metering ..... 254  
 S-RAW  
 (Small RAW) ..... 169, 171, 172, 173  
 sRGB ..... 217  
 Standard (IPB) ..... 355  
 Standard (  ) ..... 184  
 Stop down aperture ..... 250  
 Strap ..... 37  
 Strength (Sharpness) ..... 188  
 System map ..... 524

## T

Temperature warning ..... 331, 391  
 Threshold (Sharpness) ..... 188  
 Time code ..... 365  
 Time zone ..... 51  
 Time-lapse movie ..... 371  
 Tone priority ..... 206  
 Toning effect (Monochrome) ..... 189  
 Touch beeping ..... 76  
 Touch operation ..... 70, 409  
 Touch shutter ..... 327  
 Tracking sensitivity ..... 132  
 Tripod socket ..... 30  
 Troubleshooting ..... 554  
 Tv (Shutter-priority AE) ..... 246, 335  
 Two-image display ..... 408

## U

Ultra DMA (UDMA) ..... 46, 171  
 Underscore “\_” ..... 217, 222  
 USB (DIGITAL)  
 terminal ..... 29, 38, 466, 596

User Def. (  ) ..... 185  
 UTC (Coordinated Universal  
 Time) ..... 228

## V

Vertical image auto rotation ..... 444  
 Video system ..... 351, 432, 549  
 Viewfinder  
   Dioptric adjustment ..... 57  
   Electronic level ..... 83  
   Grid ..... 81  
   Information display ..... 84  
 Viewing on a TV set ..... 420, 432  
 Volume (movie playback) ..... 423

## W

Warning icon ..... 489  
 White balance (WB) ..... 192  
   Auto ..... 194  
   Bracketing ..... 199  
   Color temperature setting ..... 197  
   Correction ..... 198  
   Custom ..... 195  
 White priority (AWB) ..... 194  
 Wind filter ..... 363

## Z

Zone AF ..... 105, 110



# **MEMO**

---

---

---

---

---

---

---

---

---

---

---

---

---

---

---

---

---

---

---

---

---

---

---

---

**Canon**

**EOS 5D Mark IV**  
**EOS 5D Mark IV (WG)**

**Wi-Fi (Wireless Communication) Function  
Basic Instruction Manual**

In Wi-Fi (Wireless Communication) Function Basic Instruction Manual, basic operation procedures for easy-to-use “Communicate with a smartphone” and “Save images to Connect Station” are explained.

# Introduction

## What You Can Do Using the Wi-Fi® (Wireless Communication) Functions

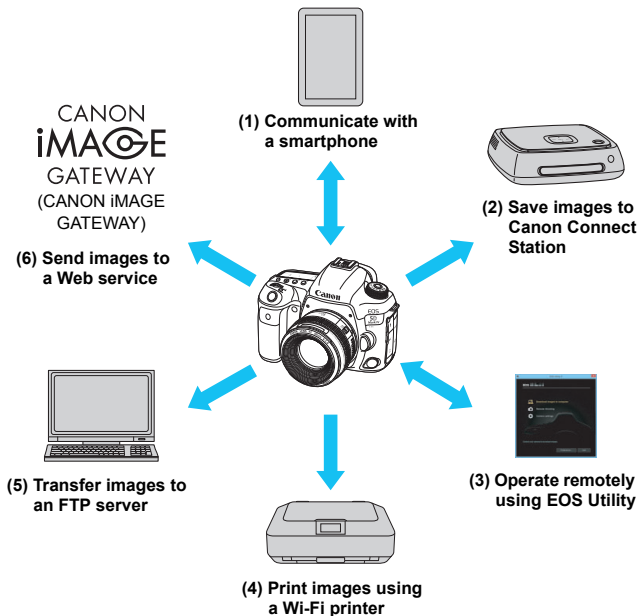

## (1) **Communicate with a smartphone**

Connect the camera to a smartphone or tablet wirelessly and use the dedicated application “Camera Connect” to operate the camera remotely or view images stored in the camera.

In this manual and on the camera’s LCD monitor, “smartphone” refers to smartphones and tablets.

NFC\* -enabled smartphones can be connected by touching them to the camera.

\* Near Field Communication

## (2) **Save images to Connect Station**

Hold the camera close to Connect Station (sold separately) to connect to and save images to it.

## (3) **Operate remotely using EOS Utility**

Connect the camera to a computer wirelessly and operate the camera remotely using EOS Utility (EOS software).

## (4) **Print images using a Wi-Fi printer**

Wirelessly connect the camera to a printer supporting PictBridge (Wireless LAN) to print images.

## (5) **Transfer images to an FTP server**

Wirelessly connect the camera to an FTP server to transfer captured images.

## (6) **Send images to a Web service**

Share images with your family and friends or share images using various Web services via CANON iMAGE GATEWAY, an online photo service for Canon users (free registration required).



- Update the Connect Station firmware to the latest version.
- CANON iMAGE GATEWAY Web services are not supported in certain countries and areas. For information on supported countries and areas, refer to the Canon Web site ([www.canon.com/cig](http://www.canon.com/cig)).

## Easy Connection Using the NFC Function

This camera can be easily connected to an NFC-enabled smartphone or Connect Station (sold separately) using the NFC function. For details, see page W-16.

## Instruction Manual

For how to use [**Remote control (EOS Utility)**], [**Print from Wi-Fi printer**], [**Transfer images to FTP server**], and [**Upload to Web service**] and for more detailed procedures, refer to the “Wi-Fi (Wireless Communication) Function Instruction Manual” PDF file. The “Wi-Fi (Wireless Communication) Function Instruction Manual” PDF file can be downloaded from the Canon Web site.

- Note that Canon cannot be held liable for any loss or damage from erroneous wireless communication function settings for using the camera. In addition, Canon cannot be held liable for any other loss or damage caused by use of the camera.
- When using wireless communication functions, establish appropriate security at your own risk and discretion. Canon cannot be held liable for any loss or damage caused by unauthorized access or other security breaches.



# Contents

## Introduction W-2

What You Can Do Using the Wi-Fi (Wireless Communication) Functions... W-2

Conventions Used in this Manual ..... W-6

## 1 Preparation and Basic Operation W-7

Registering a Nickname..... W-8

Basic Operation and Settings ..... W-11

NFC Function..... W-16

Preparation for Smartphones..... W-18

## 2 Easy Connection to a Smartphone W-19

Connection Method..... W-20

Connecting to an NFC-enabled Smartphone..... W-21

Connecting with **[Easy connection]**..... W-24

Operating the Camera Using a Smartphone..... W-28

Sending Images to a Smartphone ..... W-31

Specifying Viewable Images ..... W-38

Reconnecting ..... W-42

## 3 Easy Connection to Connect Station W-43

Saving Images ..... W-44

Wi-Fi (Wireless LAN) Precautions ..... W-46

Index ..... W-48

# Conventions Used in this Manual

In this manual, the terms “wireless” and “wireless LAN” are used as general terms for Wi-Fi and Canon’s original wireless communication functions.

The term “access point” indicates wireless LAN terminals (wireless LAN access points, wireless LAN routers, etc.) that relay wireless LAN connection.

## Icons in this Manual

 : Indicates the Main Dial.

 : Indicates the Quick Control Dial.

 : Indicates the Multi-controller.

 : Indicates the Setting button.

\* In addition to the above, the icons and symbols used on the camera's buttons and displayed on the LCD monitor are also used in this manual when discussing relevant operations and functionality.

(p.\*\*): Reference page numbers for more information.

 : Warnings to prevent potential problems during operation.

 : Supplemental information.

# 1

## Preparation and Basic Operation

This chapter describes how to register a nickname (for identification) necessary for using the camera's wireless functions and the basic operations.

# Registering a Nickname

First, set the camera's nickname (for identification).

When the camera is connected to another device wirelessly, the nickname will be displayed on the device. **Be sure to set a nickname as otherwise you cannot set the wireless functions.**

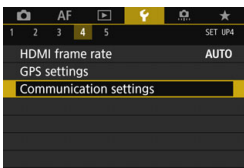

## 1 Select [Communication settings].

- Press the <MENU> button, select [Communication settings] under the [4] tab, and press <SET>.

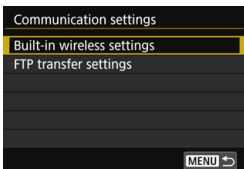

## 2 Select [Built-in wireless settings].

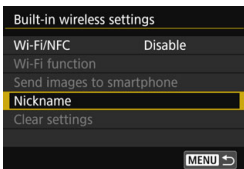

## 3 Select [Nickname].

- ▶ When this setting is selected for the first time, a screen to register a nickname is displayed. Press <SET> and proceed to step 4.

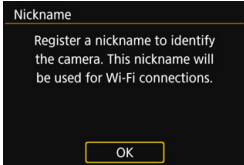



## 4 Enter a nickname.

- For instructions on entering characters, see the next page.
- When using the default nickname (the camera name), proceed to step 5.
- Otherwise, enter any characters between 1 to 10 characters in length.

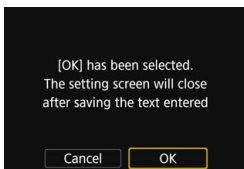

## 5 Exit the setting.

- When you are finished, press the <MENU> button.
- Select [OK] on the confirmation dialog and press <SET> to return to the menu screen.

 Since the nickname is a required wireless setting, you cannot delete all the characters.

## Virtual Keyboard Operation



- Changing the entry area**  
 Press the <Q> button to toggle between the top and bottom entry areas.
- Moving the cursor**  
 Use <⊙> or <⊕> in the top area to move the cursor.

- Entering text**

In the bottom area, use <⊙> or <⊕> to select a character, then press <SET> to enter it.

You can check how many characters you have entered and how many more can be entered by referring to [\*/] on the upper right of the screen.

- Changing the entry mode\***

Select [Aa=1@] at the bottom right of the bottom entry area. Each time you press <SET>, the entry mode will change as follows: Lower case → Numerals / Symbols 1 → Numerals / Symbols 2 → Upper case.

\* When [Touch control: Disable] is set, you can enter all characters on one screen.

- Deleting a character**

Press the <⏪> button to delete one character.

- Finishing the text entry**

Press the <MENU> button to confirm what you have entered and exit. If a confirmation dialog is displayed, select [OK] to exit.

- Canceling the text entry**

Press the <INFO.> button to cancel text entry and exit. If a confirmation dialog is displayed, select [OK] to exit.

# Basic Operation and Settings

The basic operation for using the camera's wireless functions is explained here. Follow the procedures below.

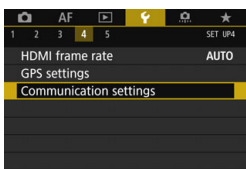

## 1 Select [Communication settings].

- Press the <MENU> button, select [Communication settings] under the [4] tab, and press <SET>.

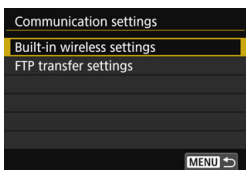

## 2 Select [Built-in wireless settings].

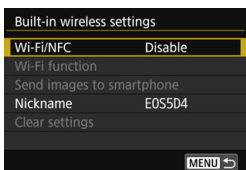

## 3 Select [Wi-Fi/NFC].

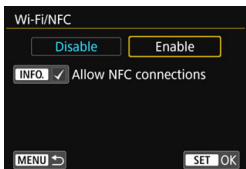

## 4 Select [Enable].

- When a nickname (for identification) is not registered, a registration screen is displayed. See page W-8 to register a nickname.
- ▶ [Wi-Fi function] is now selectable.

 You can operate wireless functions also by touching the camera's screen.

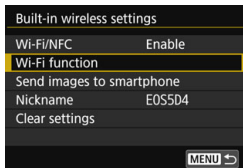

## 5 Select [Wi-Fi function].

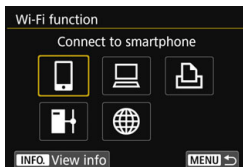

## 6 Select the Wi-Fi function to connect to.

- Use <⊙> or <⊙> to select an item, then press <SET>.
  - ▶ When the connection settings are not registered, the setting screen is displayed.
  - ▶ When the connection settings are already registered, the reconnection screen is displayed (p.W-42).
- When using the NFC function, see page W-16.

## [Built-in wireless settings] Screen

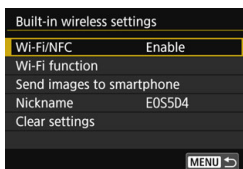

The **[Built-in wireless settings]** screen displayed in step 5 is the portal screen for setting the wireless functions.

- Select an item and press <SET> to display the setting screen, then specify the settings.
- On the **[Built-in wireless settings]** screen, you can set the following items:



## **[Wi-Fi/NFC]**

Set whether to **[Enable]** or **[Disable]** the wireless functions. You can also set whether to enable or disable the NFC function.

- Set to **[Enable]** to enable the selection of **[Wi-Fi function]**, **[Send images to smartphone]**, and **[Clear settings]**.
- When the use of electronic devices and wireless devices is prohibited, such as on board airplanes or in hospitals, set it to **[Disable]**.

## **[Wi-Fi function]**

The following Wi-Fi functions are available:

- Connect to smartphone
- Remote control (EOS Utility)
- Print from Wi-Fi printer
- Transfer images to FTP server
- Upload to Web service

## **[Send images to smartphone]**

While the camera is connected to a smartphone, use this function to send images stored in the camera to the smartphone.

## **[Nickname]**

Register or change the nickname.

## **[Clear settings]**



Clear all built-in wireless communication settings.

- When multiple exposures or time-lapse movie is set, you cannot select [**4: Communication settings**].

#### **Interface Cable Connection Cautions**

- During a wireless LAN connection, you cannot use the camera by connecting it to Connect Station, a computer, a wireless file transmitter, or another device with a cable. Terminate the connection before connecting a cable.
- When the camera is connected to Connect Station, a computer, a wireless file transmitter, or another device with a cable, you cannot select [**Built-in wireless settings**]. Disconnect the cable before changing any settings.

#### **Cards**

- For [] and [, the camera cannot be connected wirelessly if a card with images recorded is not inserted into the camera.

#### **Using the Camera with a Wireless Connection Established**

- When you want to prioritize the wireless connection, do not operate the power switch, card slot cover, battery compartment cover, or other parts. Otherwise, the wireless connection may be terminated.

#### **Using an Eye-Fi Card**

- When [**Wi-Fi/NFC**] is set to [**Enable**], image transfer using an Eye-Fi card is disabled.

## Wireless Connection Status

Wireless connection status can be checked on the camera's LCD monitor and LCD panel.

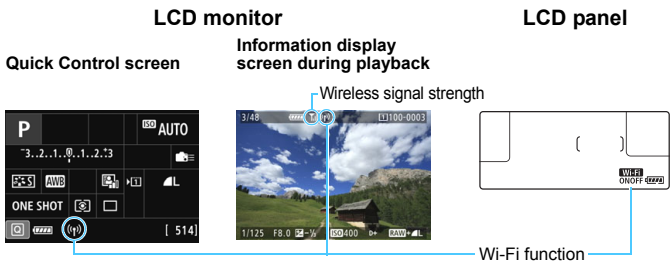

Connection status		LCD monitor		LCD panel
		Wi-Fi function	Wireless signal strength	Wi-Fi function
Not connected	Wi-Fi/NFC: Disable	(Wi-Fi) OFF	Off	Wi-Fi OFF
	Wi-Fi/NFC: Enable	(Wi-Fi) OFF		Wi-Fi ON (Blinking)
Connecting		(Wi-Fi) (Blinking)	📶	Wi-Fi ON (Blinking)
Connected		(Wi-Fi)	📶	Wi-Fi ON
Sending data		(Wi-Fi) (↔)	📶	Wi-Fi ON
Connection error		(Wi-Fi) (Blinking)	📶	Wi-Fi ON (Blinking)
Connection to FTP server stopped		(Wi-Fi)	Off	Wi-Fi ON

\* 📶 is also displayed on the screen for sending images.

\* 📶 is not displayed when the camera is connected with [Easy connection] or [Camera access point mode].

\* For the display screen during Live View shooting, refer to the Camera Instruction Manual.

# NFC Function

Using an NFC-enabled smartphone or Connect Station enables you to do the following:

- Touch a smartphone to the camera to easily connect them wirelessly (p.W-21).
- While playing back images on the camera, touch a smartphone to the camera to send a captured image to the smartphone (p.W-31).
- Hold the camera close to Connect Station (sold separately) to easily connect them wirelessly (p.W-44).

When using the NFC function, follow the steps below to set the camera's NFC setting.

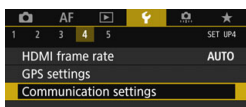

## 1 Select [Communication settings].

- Under the [4] tab, select [Communication settings], then press <SET>.

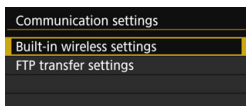

## 2 Select [Built-in wireless settings].

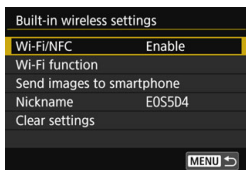

## 3 Select [Wi-Fi/NFC].

 **What is NFC?**  
NFC (Near Field Communication) is a function that can exchange information by simply bringing two NFC-enabled devices close together. This camera uses the NFC function to exchange the data for wireless connections.

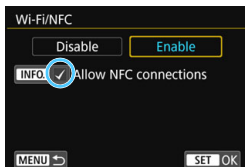

## 4 Add [✓] to [Allow NFC connections].

- Displayed when [Wi-Fi/NFC] is set to [Enable].
- Press the <INFO.> button to add or remove [✓]. Add [✓], then press <SET>.
- ▶ When a nickname (for identification) is not registered, a registration screen is displayed (p.W-8).

When establishing wireless communications using the NFC function, see the following pages.

Connecting to a smartphone wirelessly: page W-21\*

Sending images to a smartphone: page W-31\*

Connecting to Connect Station: page W-44

\* When connecting to a smartphone, see pages W-18 and W-20 as well.



### NFC Function Cautions

- This camera cannot be connected to other NFC-enabled devices, such as printers, using the NFC function.
- A connection cannot be established using the NFC function while shooting with the camera, when there is no card, or while the camera is connected to another device with an interface cable.
- To connect the camera to an NFC-enabled smartphone, the smartphone's Wi-Fi and NFC functions must be enabled.



A connection can be established even when the camera's power is in the auto power off state. However, if a connection cannot be established, cancel auto power off, then establish a connection.

## Preparation for Smartphones

To use [ ] (Connect to smartphone), a smartphone on which iOS or Android is installed is necessary. In addition, the dedicated application Camera Connect (free of charge) must be installed on the smartphone.

- Camera Connect can be downloaded from the App Store or Google Play.
- For the operating system versions supported by Camera Connect, refer to the download site of Camera Connect.
- When an NFC-enabled smartphone is touched to the camera before installing Camera Connect, the download screen of Camera Connect will be displayed on the smartphone.
- Interface or functions of the camera and Camera Connect are subject to change for firmware update of the camera or application update of Camera Connect, iOS, Android, etc. In such a case, features of the camera or Camera Connect may differ from sample screens or operation instructions in this manual.



# Easy Connection to a Smartphone

Communicating with a smartphone enables you to perform the following:



- View images stored in the camera on a smartphone or save viewed images to a smartphone.
- Operate the camera to take a picture or change camera settings using a smartphone.
- Send images to a smartphone from the camera.

This section explains how to connect the camera directly to a smartphone via Wi-Fi.

- Install Camera Connect on the smartphone before setting up a connection (p.W-18).
- For procedures to send images to an NFC-enabled smartphone, see page W-31.

## Connection Method

- **When the smartphone is NFC-enabled: See page W-21.**  
You can easily set up a connection using the NFC function.
- **When the smartphone is not NFC-enabled: See page W-24.**  
Set up a connection by selecting [**Easy connection**].

Smartphones labeled with the  mark are NFC-enabled. Some smartphones are not labeled with the  mark even if they are NFC-enabled; if you do not know whether your smartphone is NFC-enabled, contact the manufacturer of the smartphone.

 A connection may not be established with the NFC function even if the smartphone is NFC-enabled.

 NFC-enabled smartphones can also be connected by selecting [**Easy connection**] or [**Select a network**].



## Connecting to an NFC-enabled Smartphone

NFC-enabled smartphones can be connected by touching them to the camera.

The operation flow is as follows.

(1) Turn on the camera and smartphone.

(2) Enable the NFC function on the camera and smartphone.

(3) Touch the smartphone to the camera so that they come into contact with each other.

- For the camera's NFC setting, see page W-16.
- For the smartphone's Wi-Fi setting, NFC setting, and NFC antenna position, refer to the smartphone's instruction manual.

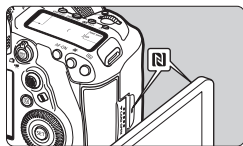

1 Enable the NFC function on the camera and smartphone (p.W-16).

2 Touch a smartphone to the camera.

- If the download site of Camera Connect appears on the smartphone, install Camera Connect (p.W-18).
  - If an image is being played back on the camera, press the <▶> button to end the playback.
  - Touch the **N** mark on the smartphone to that on the camera.
  - **When a message indicating the connection is being established is displayed on the camera's LCD monitor**, move the smartphone away from the camera.
- ▶ Camera Connect starts on the smartphone and establishes a connection.



The device name set on  
Camera Connect

### 3 Connect to the camera.

- When a connection is established, the screen on the left will appear on the camera's LCD monitor. When connecting to the same smartphone, this screen will not appear again.
- To specify viewable images, press the <INFO.> button. See step 7 on page W-40 to set them.
- Select [OK] and press <SET>. After a message is displayed, the [Wi-Fi on] screen will appear.

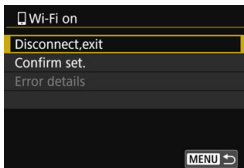

- ▶ The main window of Camera Connect will be displayed on the smartphone.
- To return to the menu, press the <MENU> button.

The settings for connecting to a smartphone are now complete.  
For operations after setting up a connection, see page W-28.

 You can check or change the device name on the setting screen of Camera Connect.



- **If necessary, also read “NFC Function Cautions” (p.W-17).**
- When touching the smartphone to the camera, be careful not to drop the camera or smartphone.
- Do not touch the smartphone to the camera with too much force. Doing so can scratch the camera or smartphone.
- Just holding the smartphone close to the mark may not establish a connection. Be sure to touch the mark with the smartphone so that they come into contact with each other.
- Recognition may be difficult depending on the smartphone. Touch slowly while changing the position or rotating horizontally.
- Another application on the smartphone may start depending on how you touch. Check the position of the  mark, then touch again.
- When touching the smartphone to the camera, do not leave anything between the camera and smartphone. In addition, when a case is attached to the camera or smartphone, communication may not be possible via NFC function.



- The camera cannot be connected to two or more smartphones at the same time.
- By default, the connection settings with the NFC function are saved as the fourth setting (a setting dedicated to NFC connection) under the name **[SET4(NFC)]**. When you connect the camera to another smartphone via NFC, **[SET4(NFC)]** will be overwritten.
- While connected, the camera's auto power off does not function.

# Connecting with [Easy connection]

The camera and a smartphone can be directly connected via Wi-Fi. To establish connection, operations on the smartphone are required. For details, refer to the smartphone's instruction manual.

## Operation on the Smartphone-1

- 1 Install Camera Connect on the smartphone (p.W-18).

## Operation on the Camera-1

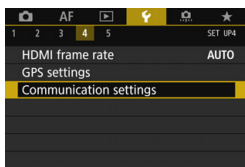

- 2 Select [Communication settings].
  - Under the [4] tab, select [Communication settings], then press < (SET) >.

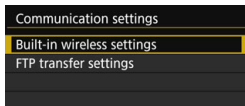

- 3 Select [Built-in wireless settings].

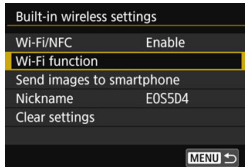

- 4 Select [Wi-Fi function].
  - Set [Wi-Fi/NFC] to [Enable], then select [Wi-Fi function] (p.W-12).
  - If a screen for setting a nickname (for identification) appears, register a nickname (p.W-8).

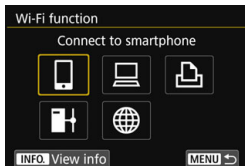

- 5 Select [☐] (Connect to smartphone).

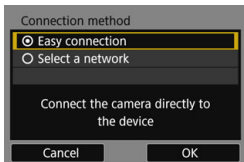

## 6 Select [Easy connection].

- Select [OK] and press <SET> to go to the next screen.

## Operation on the Smartphone-2

### Smartphone's screen (sample)



## 7 Operate the smartphone and connect it to the camera.

- Activate the smartphone's Wi-Fi function, then select the SSID (network name) displayed on the camera's LCD monitor.
- For the password, enter the encryption key displayed on the camera's LCD monitor.

### Camera's screen

SSID (network name)

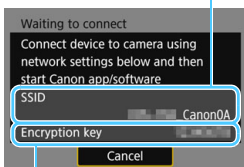

Encryption key (password)

 When connecting by selecting [Easy connection], “\_Canon0A” is displayed at the end of the SSID.



## 8 Start Camera Connect on the smartphone.

- When the [Waiting to connect] screen is displayed on the camera's LCD monitor, start Camera Connect on the smartphone.

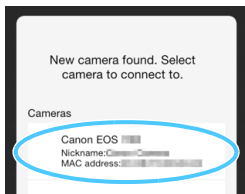

## 9 Select the camera to connect to on the smartphone.

- Select and tap the camera to connect to from [Cameras] on Camera Connect.

## Operation on the Camera-2

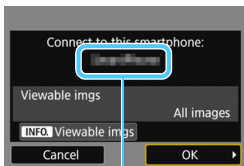

The device name set on  
Camera Connect

### 10 Connect to the camera.

- When a connection is established, the screen on the left will appear on the camera's LCD monitor.
- To specify viewable images, press the <INFO.> button. See step 7 on page W-40 to set them.
- Select [OK] and press <SET>. After a message is displayed, the [Wi-Fi on] screen will appear.

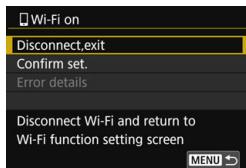

- ▶ The main window of Camera Connect will be displayed on the smartphone.
- To return to the menu, press the <MENU> button.

The settings for connecting to a smartphone are now complete.



- You can check or change the device name on the setting screen of Camera Connect.
- While connected, the camera's auto power off does not function.

# Operating the Camera Using a Smartphone

You can use a smartphone with Camera Connect installed to view images stored in the camera or perform remote shooting, etc.

## Camera Connect Main Window

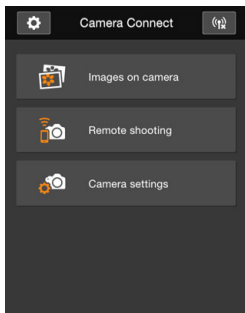

The main functions of Camera Connect are described below. Touch the screen to learn the operation procedures.

### [Images on camera]

- Images stored in the camera can be viewed.
- Images stored in the camera can be saved on a smartphone.
- Operations such as deletion can be performed on images stored in the camera.

### [Remote shooting]

- The camera's Live View image can be viewed using a smartphone.
- You can shoot using remote operation.

### [Camera settings]

- Camera settings can be changed.

### ⚙️ (Settings button)

- Use this button to access various settings for Camera Connect.



## Terminating the Connection

To terminate the connection, perform either of the following operations.

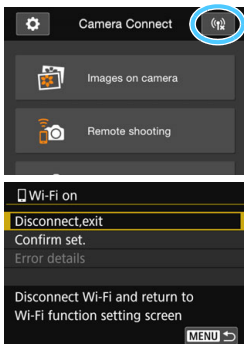

**On the smartphone's Camera Connect screen, tap [Connection icon].**

**On the camera's [Wi-Fi on] screen, select [Disconnect,exit].**

- If the [Wi-Fi on] screen is not displayed, select the [4] tab → [Communication settings] → [Built-in wireless settings] → [Wi-Fi function].
- Select [Disconnect,exit], then select [OK] on the confirmation dialog to terminate the connection.

- When the wireless connection is terminated while recording a movie with remote shooting, the camera responds as follows:
  - When the Live View shooting/Movie shooting switch is set to <📹>, movie shooting continues.
  - When the Live View shooting/Movie shooting switch is set to <📷>, movie shooting stops.
- When the Live View shooting/Movie shooting switch is set to <📷> and the movie mode is set by operating Camera Connect, you cannot shoot by operating the camera.
- While connected, certain menu items are unavailable.
- In remote shooting, the AF speed may become slower.
- Depending on the connection status, image display or shutter release may be delayed.
- When saving images to a smartphone, you cannot take a picture even if you press the camera's shutter button. Also, the camera's LCD monitor may turn off.
- Even if MOV-format movies are displayed in the list, they cannot be saved to a smartphone.

- The wireless connection will stop if you set the camera's power to <OFF> or open the card slot cover or battery compartment cover.
- When saving RAW images to a smartphone, they are saved as JPEG images.
- While connected, the camera's auto power off does not function.
- While connected, disabling the smartphone's power saving function is recommended.

# Sending Images to a Smartphone

Operate the camera to send images to a smartphone. The following three send methods are available:

- (1) While playing back an image, connect to a smartphone using the NFC function.
- (2) During a wireless connection, select [**Send images to smartphone**] from the camera menu (p.W-32).
- (3) During a wireless connection, send images from the Quick Control screen during playback (p.W-34).

## (1) Connecting with the NFC Function

While playing back an image on the camera, touch an NFC-enabled smartphone to the camera to send the image.

- If a connection is already established wirelessly, terminate the connection and then play back an image on the camera.
- Set up the camera to allow use of its NFC function in advance (p.W-16).
- For the smartphone's Wi-Fi setting, NFC setting, and NFC antenna position, refer to the smartphone's instruction manual.

**1 Enable the NFC function on the camera and smartphone (p.W-16).**

**2 Play back the image.**

- Press the <▶> button to play back images.



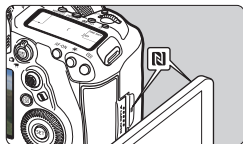

### 3 Touch a smartphone to the camera.

- Touch the **N** mark on the smartphone to that on the camera.
- If the download site of Camera Connect appears on the smartphone, install Camera Connect (p.W-18).
- When a message indicating the connection is displayed on the camera's LCD monitor, move the smartphone away.



### 4 Select the images to send.

- ▶ Select and send image(s). For information on how to send images, see page W-35.
- When the index display is selected in step 2, the multiple image selection screen will appear. See step 3 on page W-36.

## (2) Selecting [Send images to smartphone]

While the camera is connected to a smartphone wirelessly, select **[Send images to smartphone]** and send.

### 1 Connect the camera to a smartphone wirelessly.

- For connection methods, see page W-19.

### 2 Select [Communication settings].

- Under the [**F4**] tab, select **[Communication settings]**, then press **<SET>**.

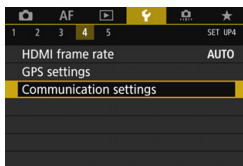

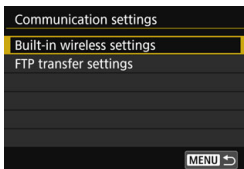

### 3 Select [Built-in wireless settings].

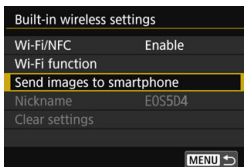

### 4 Select [Send images to smartphone].

- Select [Send images to smartphone] on the [Built-in wireless settings] screen, then press <  >.



### 5 Select the images to send.

- ▶ Select and send image(s). For information on how to send images, see page W-35.

### (3) Quick Control During Playback

While the camera is wirelessly connected to a smartphone, send images from the Quick Control screen during playback.



#### 1 Connect the camera to a smartphone wirelessly.

- For connection methods, see page W-19.

#### 2 Play back the image and press the <Q> button.

#### 3 Select [Q].

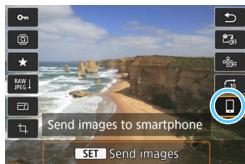

#### 4 Select the images to send.

- ▶ Select and send image(s). For information on how to send images, see page W-35.



## Sending Images Individually

Select and send images individually.



### 1 Select an image to send.

- Turn the <☉> dial to select an image to send, then press <SET>.
- If you press the <Q> button and turn the <☉> dial counterclockwise, you can select an image from the index display.

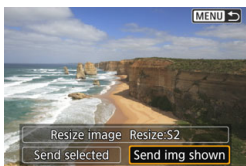

### 2 Select [Send img shown].

- To select a size at which to send the image, select [**Resize image**] and press <SET>.
- Select [**Send img shown**] and press <SET> to send the image displayed.
- ▶ When the transfer is complete, the screen for step 1 will reappear.
- To send another image, repeat steps 1 and 2.

## Sending Multiple Images

Select multiple images and send them at once.

If the multiple image selection screen is already displayed, start the operation from step 3.

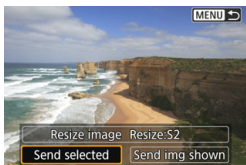

### 1 Press <SET>.

### 2 Select [Send selected].

- To select a size at which to send the images, select [**Resize image**] and press <SET>.



### 3 Select the images to send.

- Turn the <⊙> dial to select an image to send, then add [✓]. Press <SET> to add or remove [✓].
- If you press the <Q> button and turn the <☀> dial counterclockwise, you can select images from a three-image display.
- After selecting the images to send, press the <Q> button.

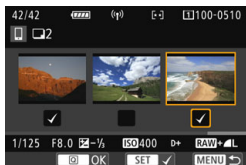

### 4 Select [Resize image].

- Set it as necessary.
- On the displayed screen, select an image size, then press <SET>.

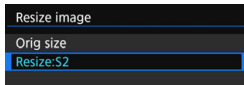
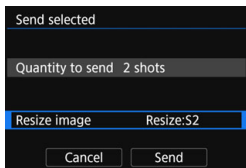

### 5 Select [Send].

- ▶ The selected images will be sent. When the transfer is complete, the screen for step 1 will reappear.
- To send other images, repeat steps 1 to 5.

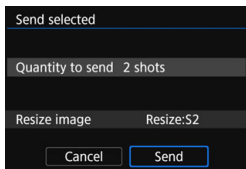



## Ending Image Transfer

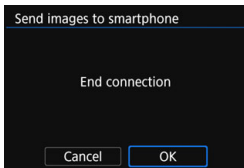

To end the image transfer, press the <MENU> button on the image transfer screen.

- If you have established the connection with the NFC function while playing back an image, the connection termination screen will appear. Select [OK] to terminate the connection.
- If you have sent images with the menu or Quick Control, the previous screen will reappear. The connection will not be terminated.



- **If necessary, also read “NFC Function Cautions” (p.W-17).**
- During the image transfer operation, a picture cannot be taken even if the camera's shutter button is pressed.
- Images cannot be sent using the NFC function while the camera is connected to another device wirelessly. In addition, the camera cannot be connected to multiple smartphones at the same time.
- Even if MOV-format movies are displayed in the list, they cannot be saved to a smartphone.



- You can cancel the image transfer by selecting [Cancel] during the transfer.
- You can select up to 50 files at a time.
- While connected, disabling the smartphone's power saving function is recommended.
- Settings for image transfer using the NFC function are not saved on the camera.
- When you reduce the image size, all images to be sent at the same time are resized. Note that movies or still photos that are smaller than **S2** size are not reduced.
- When you use a battery to power the camera, make sure it is fully charged.
- While connected, the camera's auto power off does not function.

# Specifying Viewable Images

You can specify images viewable from a smartphone by operating the camera. **Images can be specified during connection setup or after the connection is terminated.**

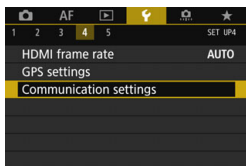

## 1 Select [Communication settings].

- Under the [4] tab, select [Communication settings], then press <SET>.

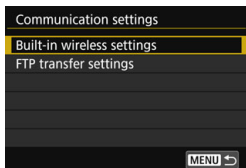

## 2 Select [Built-in wireless settings].

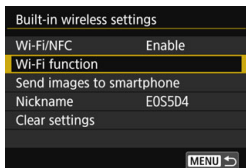

## 3 Select [Wi-Fi function].

- Set [Wi-Fi/NFC] to [Enable], then select [Wi-Fi function] (p.W-12).

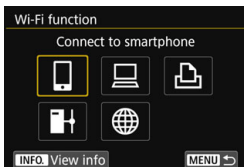

#### 4 Select [📱].

- If the [📱Wi-Fi on] screen appears, select [Disconnect,exit].

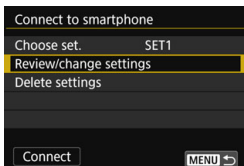

#### 5 Select [Review/change settings].

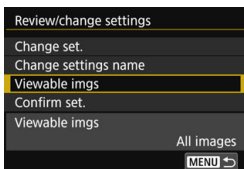

#### 6 Select [Viewable imgs].



If [Viewable imgs] is set to any setting other than [All images], remote shooting is not possible.



When reconnecting to a smartphone, check the settings of viewable images before establishing a connection.

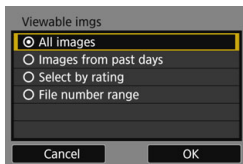

## 7 Select an item.

- Select **[OK]** and press <SET> to display the setting screen.

### [All images]

All images stored on the card become viewable.

### [Images from past days]

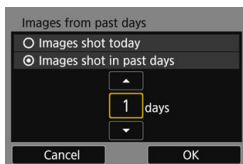

Specify viewable images on the shooting-date basis. Images shot up to nine days ago can be specified.

- Select an item, then press <SET>.
- When **[Images shot in past days]** is selected, images shot up to the specified number of days before the current date become viewable. When <⏏> is shown for the number of days, turn the <DIAL> dial to specify the number of days, then press <SET> to complete the selection.
- Select **[OK]** and press <SET> to specify the viewable images.

### [Select by rating]

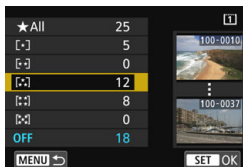

Specify viewable images depending on whether a rating is appended (or not appended) or by the type of rating.

- Select a rating, then press <SET> to specify the viewable images.

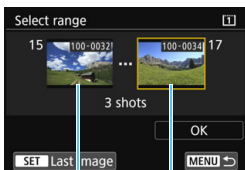
**[File number range]** (Select range)

First image

Last image

Select the first and last images from images arranged by the file number to specify the viewable images.

1 Use  $\langle \text{DIAL} \rangle$  or  $\langle \text{DIAL} \rangle$  to select the first image file.

2 Press  $\langle \text{SET} \rangle$  to display the image selection screen.

Turn the  $\langle \text{DIAL} \rangle$  dial to select an image.

If you press the  $\langle \text{Q} \rangle$  button and turn the  $\langle \text{DIAL} \rangle$  dial counterclockwise, you can select an image from the index display.

3 Select an image and press  $\langle \text{SET} \rangle$  to complete the selection.

4 Use the same operation to specify the last image file to be set as viewable. Select an image shot later than the image selected as the first image.

5 When the first and last images are specified, select **[OK]**, then press  $\langle \text{SET} \rangle$ .

# Reconnecting

The camera can reconnect to a Wi-Fi function for which connection settings is already registered.

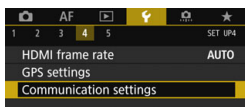

## 1 Select [Communication settings].

- Under the [**4**] tab, select [Communication settings], then press <SET>.

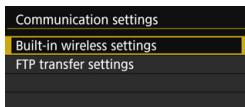

## 2 Select [Built-in wireless settings].

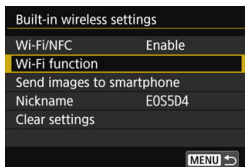

## 3 Select [Wi-Fi function].

- Set [Wi-Fi/NFC] to [Enable], then select [Wi-Fi function] (p.W-12).

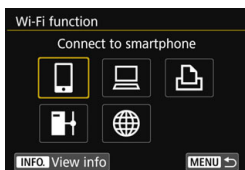

## 4 Select the Wi-Fi function to connect to.

- Use <○> or <⊕> to select an item, then press <SET>.
- When you select [**⊕**], a screen to select a Web service is displayed. Depending on the selected Web service, the [Send to] screen is displayed. Select the Web service to connect to and the destination.

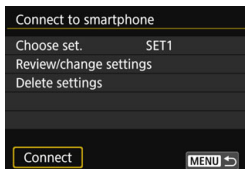

## 5 Select [Connect].

- When settings for multiple connection destinations are registered, select [Choose set.], select the connection destination, then connect to the destination.
- Select [OK] on the confirmation dialog.

# 3

## Easy Connection to Connect Station

Connect Station (sold separately) is a device that allows you to import captured still photos and movies for viewing on your TV set, smartphone, etc., or sharing them over a network.

You can easily save still photos and movies to Connect Station by holding this camera close to Connect Station.

# Saving Images

This section explains how to connect the camera and Connect Station (sold separately) wirelessly. To save images in other ways, refer to the Connect Station Instruction Manual.

- Set up the camera to allow use of its NFC function in advance (p.W-16).

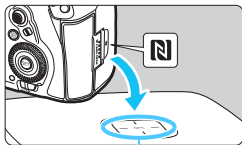

NFC connect point

- 1 Enable the NFC function on the camera** (p.W-16).
- 2 Hold the camera close to Connect Station.**

- Turn on the camera and Connect Station, then hold the camera's **N** mark close to the Connect Station's NFC connect point.
- ▶ When a message indicating the connection is being established is displayed on the camera's LCD monitor and Connect Station responds, move the camera away from Connect Station.
- When a connection is established, Connect Station checks the images on the memory card, then saves only the unsaved images.

- 3 Terminate the connection.**

- After images are saved, the screen on the left will appear on the camera's LCD monitor. Press **<SET>** to terminate the connection.

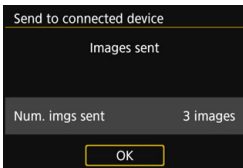





- **If necessary, also read “NFC Function Cautions” (p.W-17).**
- While saving images, a picture cannot be taken even if the camera's shutter button is pressed.
- Do not drop the camera on Connect Station or touch the camera to it with too much force. Doing so may damage Connect Station's internal hard disk.
- If the camera is not recognized right away, try holding it close to Connect Station and slowly moving it or rotating it horizontally.
- Just holding the camera close to Connect Station may not establish a connection. In such a case, gently touch Connect Station with the camera.
- When holding the camera close to Connect Station, do not leave anything between the camera and Connect Station. In addition, when a case is attached to the camera, communication may not be possible via NFC function.
- If the camera and Connect Station are moved too far away from each other while saving images, saving may take time or the connection may be terminated.
- If the camera's battery runs out while saving images, saving will stop. Charge the battery, then try again.
- 4K movies cannot be played back with Connect Station.



- When all images are already saved, saving will not be performed. In such a case, select **[OK]** to terminate the connection.
- When there are a large number of images on the memory card, it may take time to check and save the images.
- While saving images, the camera's auto power off does not function.

# Wi-Fi (Wireless LAN) Precautions

## ■ Countries and Regions Permitting Wireless LAN Use

Use of wireless LAN is restricted in some countries and regions, and illegal use may be punishable under national or local regulations. To avoid violating wireless LAN regulations, visit the Canon Web site to check where use is allowed.

Note that Canon cannot be held liable for any problems arising from wireless LAN use in other countries and regions.

## ■ Model Number

EOS 5D Mark IV (WG): DS126601 (including WLAN module model: ES200)

Complies with  
IMDA Standards  
DB00671

## FCC/IC NOTICE

**Model: DS126601 (including WLAN Module Model ES200, FCC ID: AZD230/ IC: 498J-230)**

This device complies with Part 15 of FCC Rules and Industry Canada's licence-exempt RSSs. Operation is subject to the following two conditions:

- (1) this device may not cause harmful interference, and
- (2) this device must accept any interference received, including interference that may cause undesired operation.

This transmitter must not be co-located or operated in conjunction with any other antenna or transmitter except Canon accessories supplied or designated for this product.

The available scientific evidence does not show that any health problems are associated with using low power wireless devices. There is no proof, however, that these low power wireless devices are absolutely safe. Low power Wireless devices emit low levels of radio frequency energy (RF) in the microwave range while being used. Whereas high levels of RF can produce health effects (by heating tissue), exposure of low-level RF that does not produce heating effects causes no known adverse health effects. Many studies of low-level RF exposures have not found any biological effects. Some studies have suggested that some biological effects might occur, but such findings have not been confirmed by additional research. This model has been tested and found to comply with FCC/IC radiation exposure limits set forth for an uncontrolled environment and meets the FCC radio frequency (RF) Exposure Guidelines and RSS-102 of the IC radio frequency (RF) Exposure rules.

Hereby, Canon Inc., declares that this DS126601 is in compliance with the essential requirements and other relevant provisions of Directive 1999/5/EC.

Please contact the following address for the original Declaration of Conformity:

**CANON EUROPA N.V.**

Bovenkerkerweg 59, 1185 XB Amstelveen, The Netherlands

**CANON INC.**

30-2, Shimomaruko 3-chome, Ohta-ku, Tokyo 146-8501, Japan



## Trademarks

- Microsoft and Windows are trademarks or registered trademarks of Microsoft Corporation in the United States and/or other countries.
- Macintosh and Mac OS are trademarks of Apple Inc., registered in the U.S. and other countries.
- The Wi-Fi CERTIFIED logo and the Wi-Fi Protected Setup mark are trademarks of the Wi-Fi Alliance.
- WPS used on camera settings screens and in this manual stands for Wi-Fi Protected Setup.
- UPnP is a trademark of the UPnP Implementers Corporation.
- The N-Mark is a trademark or registered trademark of NFC Forum, Inc. in the United States and in other countries.
- All other trademarks are the property of their respective owners.

# Index

**A**  
Android ..... W-18

**C**  
Cables ..... W-14  
Camera Connect ..... W-18, W-28  
Communicating with a  
smartphone ..... W-19  
Connect Station ..... W-43

**E**  
Eye-Fi Card ..... W-14

**I**  
iOS ..... W-18

**K**  
Keyboard ..... W-10

**N**  
NFC ..... W-16, W-20, W-21, W-44  
    Sending images ..... W-31  
Nickname ..... W-8

**Q**  
Quick Control ..... W-34

**R**  
Reconnecting ..... W-42  
Reducing the image size ..... W-36  
Remote operation ..... W-28

**S**  
Sending images ..... W-31

**T**  
Touch Control ..... W-11

**V**  
Viewable images ..... W-39  
Viewing images ..... W-28































# Canon

The descriptions in this Instruction Manual are current as of February 2018. For information on the compatibility with any products introduced after this date, contact any Canon Service Center. For the latest version Instruction Manual, refer to the Canon Web site.